

CD PLAY SOC(COMBINED SC9820 with CLOCK)

DESCRIPTION

SC9698P is a single chip of CD paly controller. This IC have CD play, DTS, TAPE, AUX, volume control, remote control, clock display and alarm functions. This IC include CD digital servo controller, signal processor, digital audio DAC output port, and headphone amplifier. It can drive LCD display directly with the least external components.

FEATURES

- * CD player
 - Compatible with CD/CD-R/CD-RW
 - Support CD play/pause
 - Support CD previous/next track
 - Support CD fast forward/backward
 - CD single track, all tracks playing display
 - CD play display in random
 - CD play with scan
 - CD and tape synch record function
- * Radio function
 - Four frequency bands can be selectable (USA, GEN1/2, JAPAN)
 - Manual tuner
 - Automatic tuner
 - Pre-keep radio stations (FM: 10, AM/MW: 10, LW:5)
- * Tape function
 - TAPE display
- * AUX function
 - AUX function
- * Electron volume control
 - CD/radio/tape/AUX channel switch
 - Volume control and display
 - Preset POP, CLASS, ROCK three mode.
 - Support mute ON/OFF and display.
 - Support X-BASS swotcher and display.
 - Support ENCODER-VOLUME control.
- * Clock function
 - Clock display
 - Alarm clock
 - Snoozer
 - Sleep

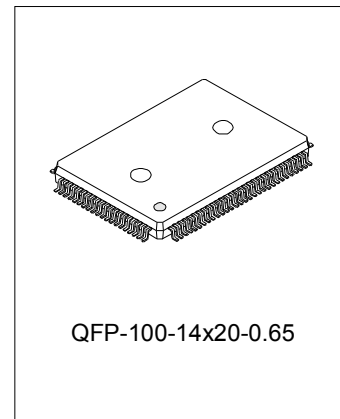

ORDERING INFORMATION

Device	Package
SC9698P	QFP-100-14X20-0.65

APPLICATIONS

- * Desk-top CD audio

BLOCK DIAGRAM

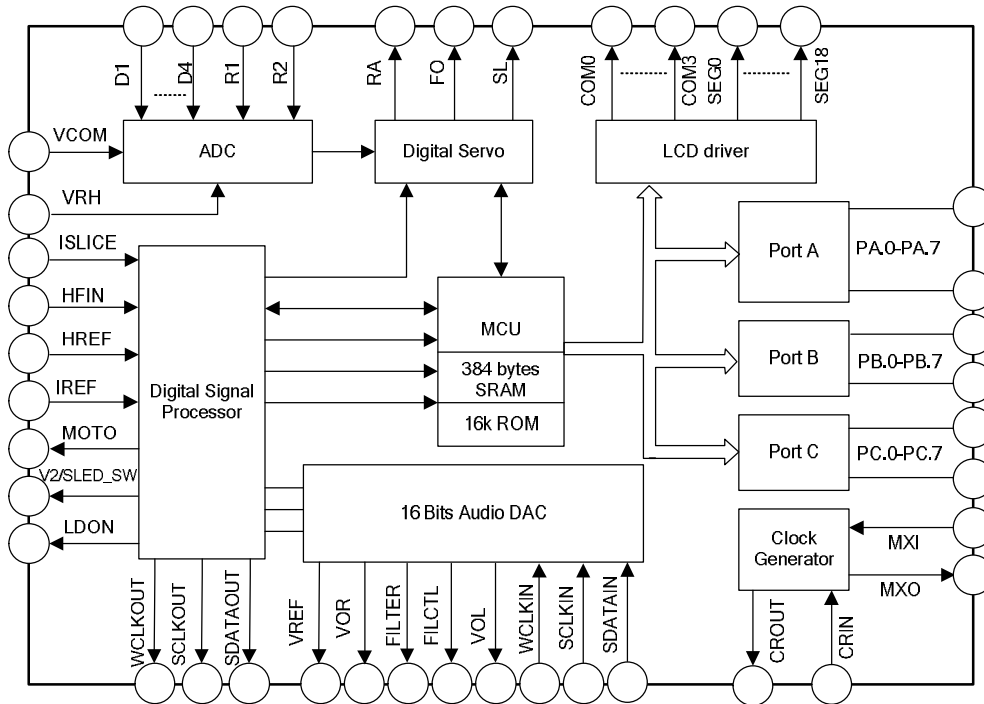

ABSOLUTE MAXIMUM RATINGS (Tamb=25°C)

Characteristics	Symbol	Range	Unit
Supply Voltage	VDD	-0.5 ~ +5.5	V
Input Voltage On Pins	VIN	-0.5 ~VDD + 0.5	V
Operating Temperature	Topr	-20 ~ +75	°C

ELECTRICAL CHARACTERISTICS (VDD=3.4~5.5V;VSS=0V;Tamb=-10~+60°C)

Characteristics	Symbol	Condition	Min.	Typ.	Max.	Unit
Supply Voltage	VDD		4.5	5.0	5.5	V
Supply Current	IDD	5V(CD operating)	—	50	—	mA
RFIN Input Signal	VRFIN		—	1	—	V
Reference Voltage	V _r		—	0.5VDD	—	
Common Mode DC	V _{com}		—	2.5	—	V
Input Current Of Central Diode 1	ID1		0	—	9	μA
Input Current Of Central Diode 2	ID2		0	—	9	μA
Input Current Of Central Diode 3	ID3		0	—	9	μA
Input Current Of Central Diode 4	ID4		0	—	9	μA
Input Current Of Satellite Diode 1	IR1		0	—	4.5	μA
Input Current Of Satellite Diode 2	IR2		0	—	4.5	μA
PA Output Current (Low-Level)	IOL(A)		—	10	—	mA
PA Output Current(High-Level)	IOH(A)		—	10	—	mA

(To be continued)

(Continued)

Characteristics	Symbol	Condition	Min.	Typ.	Max.	Unit
PB Output Current (Low-Level)	IOL(B)		—	10	—	mA
PB Output Current(High-Level)	IOH(B)		—	10	—	mA
PC Output Current (Low-Level)	IOL(C)		—	10	—	mA
PC Output Current(High-Level)	IOH(C)		—	10	—	mA
LDON Output Current Low-Level	ILDON		0	—	2	mA
Output Load Resistance DAC	RL		5	—	—	KΩ
Full-Scale DAC Output Voltage	VFS		0.9	1.1	1.2	V
RAD Output Current	IRAD		0	1	—	mA
FOC Output Current	IFOC		0	1	—	mA
SLED Output Current	ISLED		0	1	—	mA
MOTO Output Current	IMOTO		0	5	10	mA
Low Level Output Voltage	VOLDRIVE1	RAD, FOC, SELD	0	—	0.4	V
High Level Output Voltage	VOHDRIVE1	RAD, FOC, SELD	VDD-0.4	—	VDD	V
Moto Low Level Output Voltage	VOLmoto		0	—	1.0	V
Moto High Level Output Voltage	VOHmoto		VDD-1	—	VDD	V
RAD, FOC, SLED, MOTO Output 3-State Leakage Current	IZODRIVE	RAD, FOC, SELD, MOTO	-10	0	+10	μA
DAC Total Harmonic Distortion Plus Noise	(THD+N)/S		60	65	70	dB
DA Filter Attenuation	Filter_DA	0 to 19 kHz	-	-	0.001	dB
		19 to 20 kHz	1	-	2	dB
		24KHz	25	-	-	dB
		25 to 35 KHz	40	-	-	dB
		35 to 64 KHz	50	-	-	dB
		64 to 68 KHz	31	-	-	dB
		68 KHz	35	-	-	dB
		69 to 88 KHz	40	-	-	dB
OSC Frequency	Fsystem		—	8.4672	—	MHZ

PIN CONFIGURATION

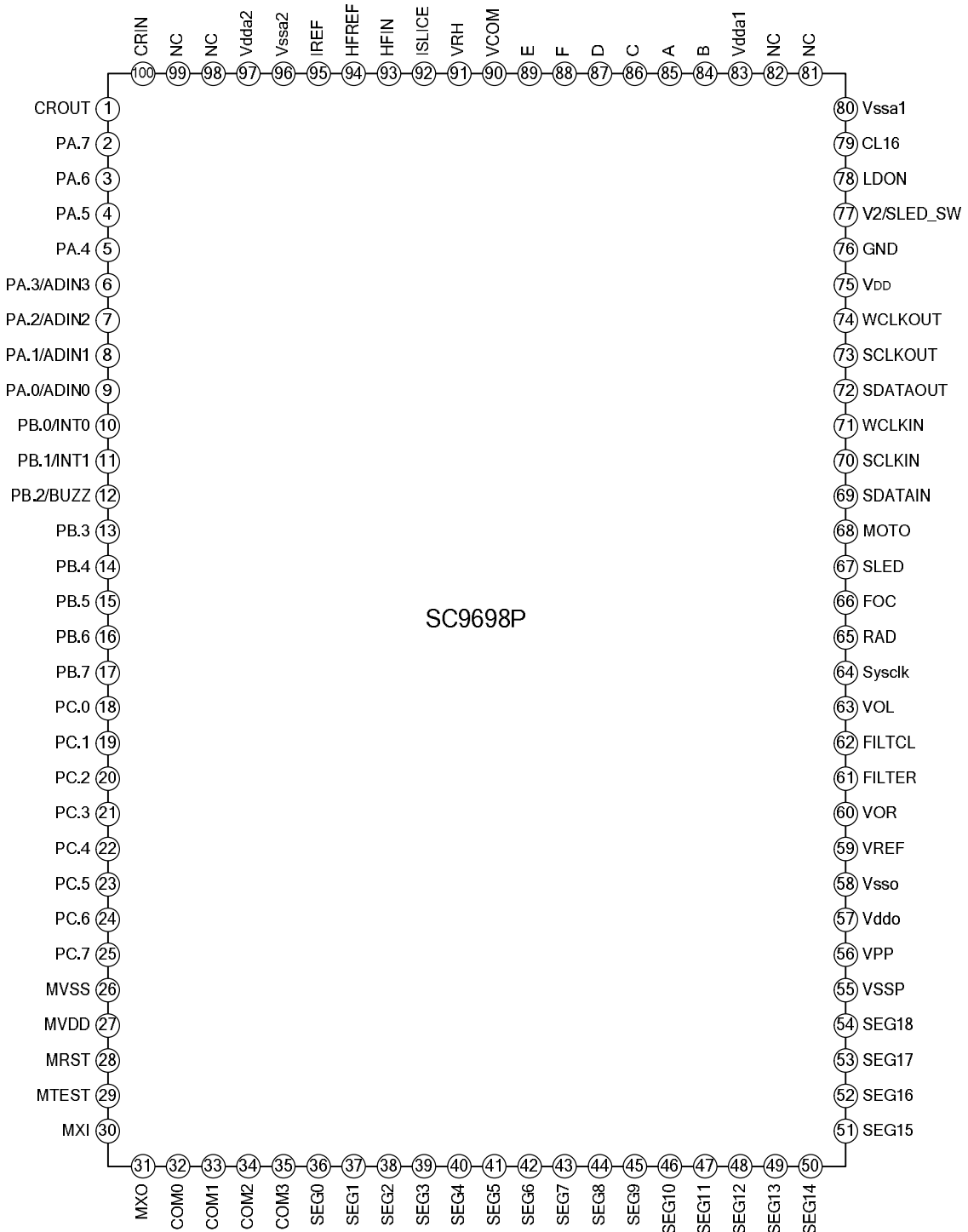

PIN DESCRIPTION

Pin no.	Symbol	I/O	Descriptions
1	CROUT	O	8.4672MHz crystal output pin.
2	PA.7	I/O	MCU general purpose I/O ports, and the function is decided by the program.
3	PA.6	I/O	
4	PA.5	I/O	
5	PA.4	I/O	
6	PA.3/ADIN3	I/O	
7	PA.2/ADIN2	I/O	
8	PA.1/ADIN1	I/O	
9	PA.0/ADIN0	I/O	
10	PB.0/INT0	I/O	
11	PB.1/INT1	I/O	
12	PB.2/BUZZ	I/O	
13	PB.3	I/O	
14	PB.4	I/O	
15	PB.5	I/O	
16	PB.6	I/O	
17	PB.7	I/O	MCU general purpose I/O ports, and the function is decided by the program.
18	PC.0	I/O	
19	PC.1	I/O	
20	PC.2	I/O	
21	PC.3	I/O	
22	PC.4	I/O	
23	PC.5	I/O	
24	PC.6	I/O	
25	PC.7	I/O	
26	MVSS	-	MCU Ground pin.
27	MVDD	-	MCU power supply pin.
28	MRST	I	MCU reset pin.
29	MTEST	I	MCU test pin.
30	MXI	I	MCU clock input pin.
31	MXO	O	MCU clock output pin.
32	COM0	O	LCD COM0 port.
33	COM1	O	LCD COM1 port.
34	COM2	O	LCD COM2 port.
35	COM3	O	LCD COM3 port.
36	SEG0	O	LCD SEG0 port.
37	SEG1	O	LCD SEG1 port.
38	SEG2	O	LCD SEG2 port.
39	SEG3	O	LCD SEG3 port.

(To be continued)

(Continued)

Pin no.	Symbol	I/O	Descriptions
40	SEG4	O	LCD SEG4 port.
41	SEG5	O	LCD SEG5 port.
42	SEG6	O	LCD SEG6 port.
43	SEG7	O	LCD SEG7 port.
44	SEG8	O	LCD SEG8 port.
45	SEG9	O	LCD SEG9 port.
46	SEG10	O	LCD SEG10 port.
47	SEG11	O	LCD SEG11 port.
48	SEG12	O	LCD SEG12 port.
49	SEG13	O	LCD SEG13 port.
50	SEG14	O	LCD SEG14 port.
51	SEG15	O	LCD SEG15 port.
52	SEG16	O	LCD SEG16 port.
53	SEG17	O	LCD SEG17 port.
54	SEG18	O	LCD SEG18 port.
55	VSSP	--	Grand
56	VPP	-	OTP program voltage
57	Vddo	-	DAC power supply.
58	Vsso	-	DAC ground.
59	VREF	O	Internal reference voltage output pin, the typical voltage is 0.5VDD.
60	VOR	O	DAC right channel audio output pin.
61	FILTCR	O	DAC right channel filter capacitor.
62	FILTCL	O	DAC left channel filter capacitor.
63	VOL	O	DAC left channel audio output pin.
64	Sysclk	I	DAC system clock input pin.
65	RAD	O	Tracking drive output pin.
66	FOC	O	Focus drive output pin.
67	SLED	O	Sled motor driver output pin.
68	MOTO	O	Spindle motor driver output pin.
69	SDATAIN	I	DAC data input pin.
70	SCLKIN	I	DAC bit clock input pin.
71	WCLKIN	I	DAC word clock input pin.
72	SDATAOUT	O	CD data output pin.
73	SCLKOUT	O	CD bit clock output pin.
74	WCLKOUT	O	CD word clock output pin.
75	VDD	-	CD power supply.
76	GND	-	CD ground, I/O port ground.
77	V2/SLED_SW	I	Sled motor position monitor signal input, with pull-up resistor.
78	LDON	O	Laser on signal output pin, with pull-up resistor.

(To be continued)

(Continued)

Pin no.	Symbol	I/O	Descriptions
79	CL16	O	16.9344M clock output pin.
80	Vssa1	-	Servo module ADC analog ground.
81	NC	-	Not connect
82	NC	-	Not connect
83	Vdda1	-	Servo module ADC analog power.
84	B	I	Central diode current signal input 1
85	A	I	Central diode current signal input 2
86	C	I	Central diode current signal input 3
87	D	I	Central diode current signal input 4
88	F	I	Satellite diode current signal input 1
89	E	I	Satellite diode current signal input 2
90	VCOM	I	DC voltage input pin.
91	VRH	O	ADC reference voltage output.
92	ISLICE	O	Data slice feed back current output.
93	HFIN	I	CD pick up signal input pin.
94	HFREF	I	CD pick up signal reference voltage.
95	IREF	I	Reference current output pin.
96	Vssa2	-	Ground of HF and PLL
97	Vdda2	-	Power of HF and PLL
98	NC	-	Not connect
99	NC	-	Not connect
100	CRIN	I	8.4672MHz crystal input pin.

FUNCTION DESCRIPTION
1. LCD

CLASSIC	ROCK	POP	X-BASS	
CD	TUNER	TAPE	AUX	TIMER
INTRO	MEMORY	RANDOM	REPEAT	SNOOZE
MUTE	STEREO	SYNC REC	SLEEP	REMAIN



 88 ^{FM} ^{MW} ^{LW} ^{AM PM} - 88:8.85 ^{MHz} ^{KHz}

True table:

		COM1(Pin 97)	COM2(Pin 98)	COM3(Pin 99)	COM4(Pin 100)
SEG1	1	MUTE	..	SYNC REC	REMA IN
SEG2	2	AUX	CLASSIC	ROCK	POP
SEG3	3	TAPE	LW	TIMER	SNOOZE
SEG4	4	1f	1e	1d	1c
SEG5	5	STEREO	AM	PM	5
SEG6	6	3f	3e	3d	3c
SEG7	7	RANDOM	3a	3g	3b
SEG8	8	4f	4e	4d	4c
SEG9	9	:	4a	4g	4b
SEG10	10	5f	5e	5d	5c
SEG11	11	.	5a	5g	5b
SEG12	12	6f	6e	6d	6c
SEG13	13	MEMORY	6a	6g	6b
SEG14	14	TUNER	FM	KHz	MHz
SEG15	15	CD	MW	REPEAT	SLEEP
SEG16	16	INTRO	1a	1g	1b
SEG17	17	2f	2e	2d	2c
SEG18	18	X-BASS	2a	2g	2b

2. JUMPER

A/D Value	Pickup Mechanism		Clock & Timer
0.00~0.63V	SONY	KSS-213C	Enable
0.63~1.25V	SONY	KSS-213C	Disable
1.25~1.88V	THOMSON	TCP-11TK	Enable
1.88~2.50V	THOMSON	TCP-11TK	Disable
2.50~3.12V	SANYO	DA11	Enable
3.12~3.75V	SANYO	DA11	Disable
3.75~4.38V	SAMSUNG	V75	Disable
4.38~5.00V	SAMSUNG	V75	Enable

3. KEYBOARD

1. Fran panel keyboard form:

KeyAD1(P3-1:26pin)	KeyAD2(P3-2:27pin)	KeyAD3(P3-3:28pin)	
POWER	PLAY/PAUSE	MUTE	(0.00V)
VOL-UP	STOP/BAND	INTRO	(0.63V)
VOL-DOWN	UP/FF	RANDOM	(1.25V)
FUNCTION4(CD, TUNER,TAPE, AUX)	DOWN/REW	MEMORY/CLOCK ADJ	(1.88V)
FUNCTION4 (CD, TUNER, TAPE)	REPEAT/M-UP	SLEEP/TIMER	(2.50V)
CD	OP/CL	SNOOZE	(3.13V)
TUNER	DISPLAY	Preset EQ	(3.75V)
TAPE	AUX	X-BASS	(4.38V)

2. Remote controller keyboard form:

	T0	T1	T2	T3
K0	PLAY/PAUSE	STOP/BAND	UP/FF	DOWN/REW
K1	REPEAT/M-UP	INTRO	RANDOM	MEMORY/CLOCK ADDJ
K2	SNOOZE	TIMER	SLEEP	DISPLAY
K3	POWER	Presset EQ	X-BASS	OVER
K4	1	2	3	4
K5	5	6	7	8
K6	9	0	VOL-UP	VOL-DOWN
K7	FUNCTION4(CD, TUNER, TAPE, AUX)	FUNCTION4(CD,TUN ER,TAPE)	FUNCTION4(CD, TUNER)	MUTE

4. RADIO MODE

1. Receive band:

AREA	CODE AREA0,1	BAND	FREQUENCY RANCE[Hz]	STEP[Hz]	FREQ REF[Hz]	IF
GEN2	00	FM	87.50-108.00M	50K	50K/3.125K	+10.7M/1.3375M
		MW	522-1620K	9K	9K	+450K
JAPAN	01	FM	76.0-90.0M,TV1-3	100K,1CH	25K	-10.7M
		AM	522-1629K	9K	9K	+450K
GEN1	10	FM	87.50-108.00M	50K	50K/3.15K	+10.7M/1.3375M
		MW	522-1620K	9K	9K	+450K
		LW	144-281K	1K	1K	
USA	11	FM	87.5-108.0M	100K	50K/3.125K	+10.7M/1.3375M
		AM	520-1710K	10K	10K	+450K

2. PLL (SC9257) pin descriptions

Pin no.	Pin name	I/O	Descriptions	Note
3	PERIOD	I	PLL Chip select	
4	CLOCK	I	SIO clock	
5	DATA	I/O	SIO(data line)	
6	OT1	O	FM band out	Open=FM, L=other
7	OT2	O	MW band out	Open=MW, L=other
8	OT3	O	LW band out	Open=LW, L=other
9	OT4	O	Non connection	
10	I/O5	I	Normal or 1/8 IF input select *1	0=normal IF 1=1/8 IF
11	I/O6	I	Area select	A0, 1=00: GEN2, 01:JAPAN, 10:GEN1, 11:USA
16	I/O9/IFIN2	I		
17	I/O8/IFIN1	I		
18	I/O7/SCIN	I	1/16 FM osc select it is disable when area is JAPAN *1	1=1/16 FM osc

3. Radio key functions

1) TUNER

Press this key enter radio mode.

2) BAND

This key used to switch frequency bands: FM→AM→LW(selectable)→FM

3) REW

press the key, manual search the radio station

press the key continuance, auto search the radio station until find the stations.

4) FF

press the key, manual search the radio station

press the key continuance, auto search the radio station until find the stations.

5) MEMORY UP

Take out the memory status:

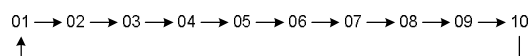

6) MEMORY

First press the MEMORY key, then press the number directly or select the station by the MEMORY UP key, it is keep in when press the MEMORY key again.

4. Radio display

1) FM BAND

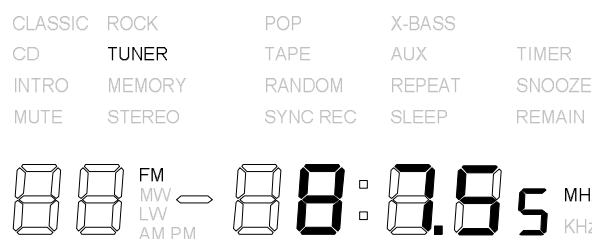

2) AM BAND

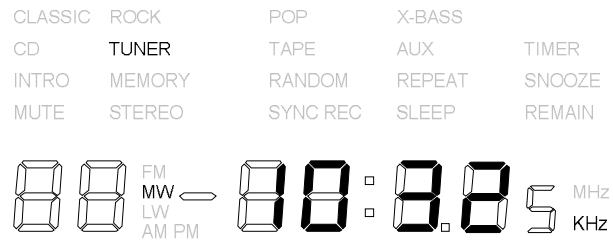

3) Display the memory status

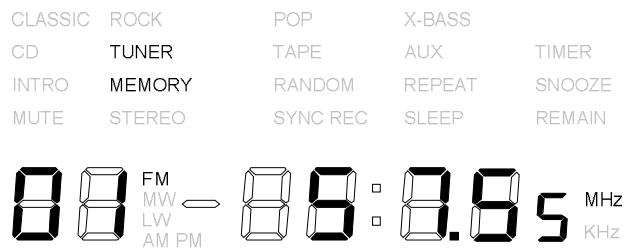

4) Display saving status

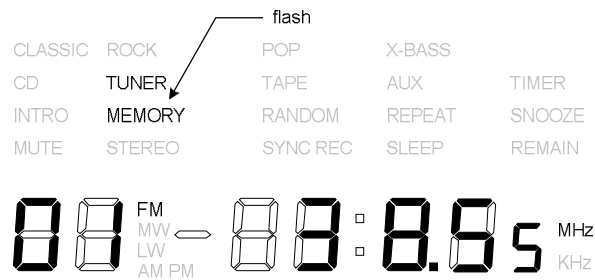

5. Tape mode

1. tape functions

1) TAPE

Press the key enter TAPE mode.

2. Display

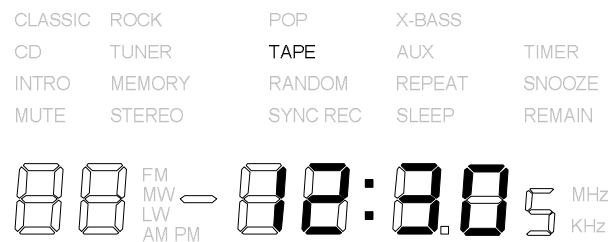

6. CD mode

1. CD key functions

1) CD

press this key enter CD mode.

2) PLAY/PAUSE

Play/pause key.

3) STOP

Stop key.

4) RANDOM

Play with random (in the RANDOM station, press REW key invalible)

5) REW

Press the key: jump to the previous track.

Reach the previous track, if the current track is the last one, then reach the first track.

Press the key continuance: fast backward

Fast backward until release the key, if it is reach the first track, then play the tracks normally.

6) FF

Press the key: reach the next track

Reach the next track , if the current track is the last one, then reach the first track.

Press the key continuance: fast forward

Fast forward until the key released, if it is reach the last one, then paly tracks normally.

7) REPEAT



8) PROGRAM

Press this key enter program station (in the STOP station)

Press the REW/FF key select tracks, the program number increased when memory one track, the maximum tracks is 20. After program, the system begin playing tracks. It will quit program status if on operation at 8 seconds, but the tracks also remained.

If press the STOP key in program status, clear all program tracks, and quit the program status.

9) INTRO

This key used to switch the scan and play functions.

2. CD display

1) STOP status, display total tracks number and total time

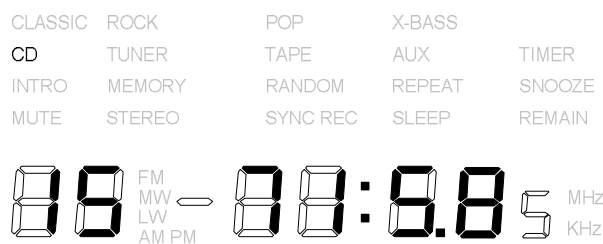

2) PLAY status display

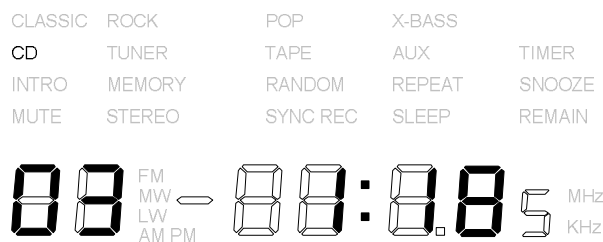

3) PAUSE status display

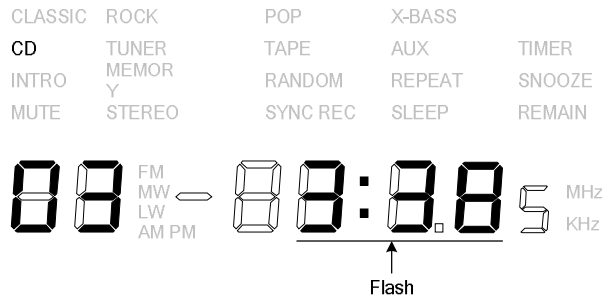

4) REW/FF status display

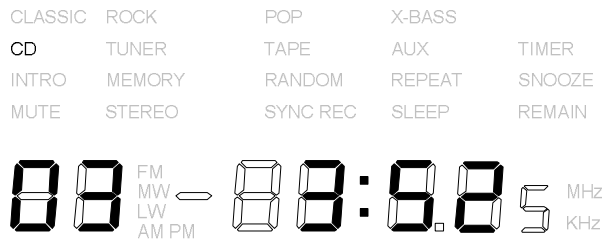

5) RANDOM status display

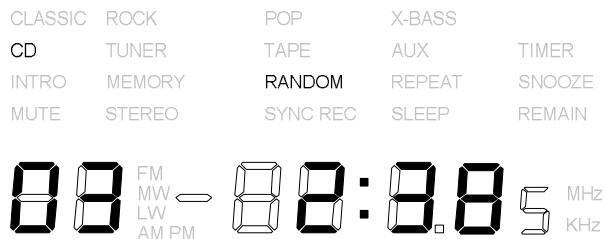

6) REPEAT ALL display (the REPEAT symbol blinking at REPEAT ONE status)

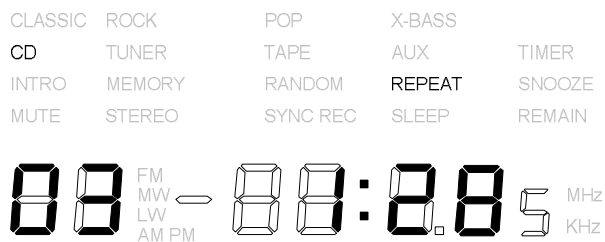

7) Program status display

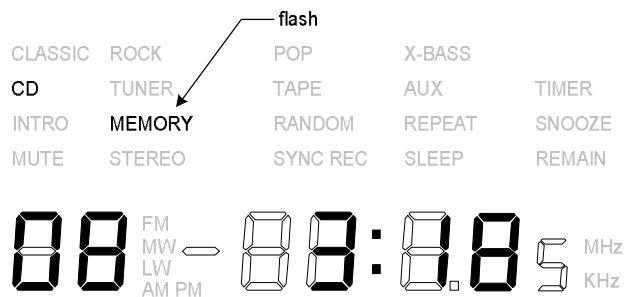

8) Programmable status display

CLASSIC	ROCK	POP	X-BASS	
CD	TUNER	TAPE	AUX	TIMER
INTRO	MEMORY	RANDOM	REPEAT	SNOOZE
MUTE	STEREO	SYNC REC	SLEEP	REMAIN

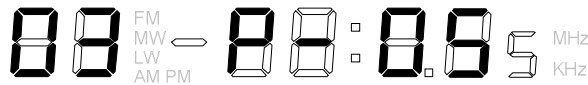

88 FM MW LW AM PM — 88.5 MHz
KHz

7. Volume mode

1. Volume key description

1) VOLUME+/-

Volume increment or minishreduce.

2) MUTE

Mute ON/OFF control.

3) EQ

Switch the pre-set mode

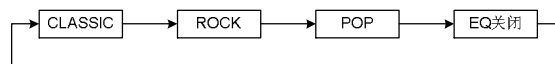

2. volume display

1) VOLUME

CLASSIC	ROCK	POP	X-BASS	
CD	TUNER	TAPE	AUX	TIMER
INTRO	MEMORY	RANDOM	REPEAT	SNOOZE
MUTE	STEREO	SYNC REC	SLEEP	REMAIN



88 FM MW LW AM PM — 88.5 MHz
KHz

8. other function

1. Descriptions

1) CLOCK

Press the DISPLAY key until reach the time mode, press the key MEMORY continuance, it enter time setting station, then press the UP/DOWN key adjust the time.

2) SLEEP

Press the SLEEP key, it enter sleep station, press the key again, set the sleep time (90~10 minutes).

When setting the sleep time, the SLEEP symbol blink in the LCD , and after timer turn on, the SLEEP symbol displayed in the LCD, press the SLEEP key again cancel the timer.

3) TIMER

Start by the setting time(alarm).

Adjust the time.

4) STAND BY/ON

Standby /ON switch

2. Display

1) Standby status

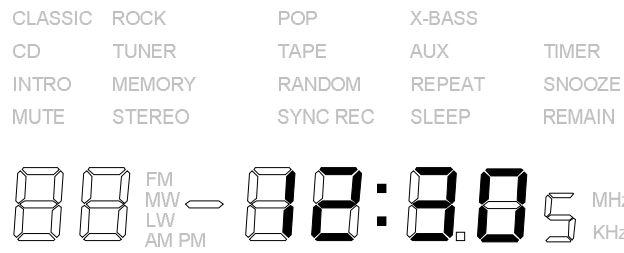

2) TAPE

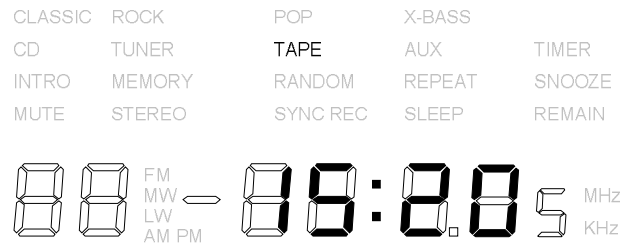

3) TIMER

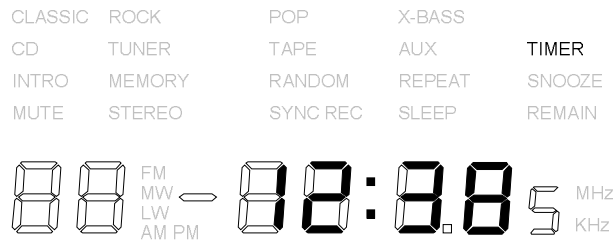

TYPICAL APPLICATION CIRCUIT

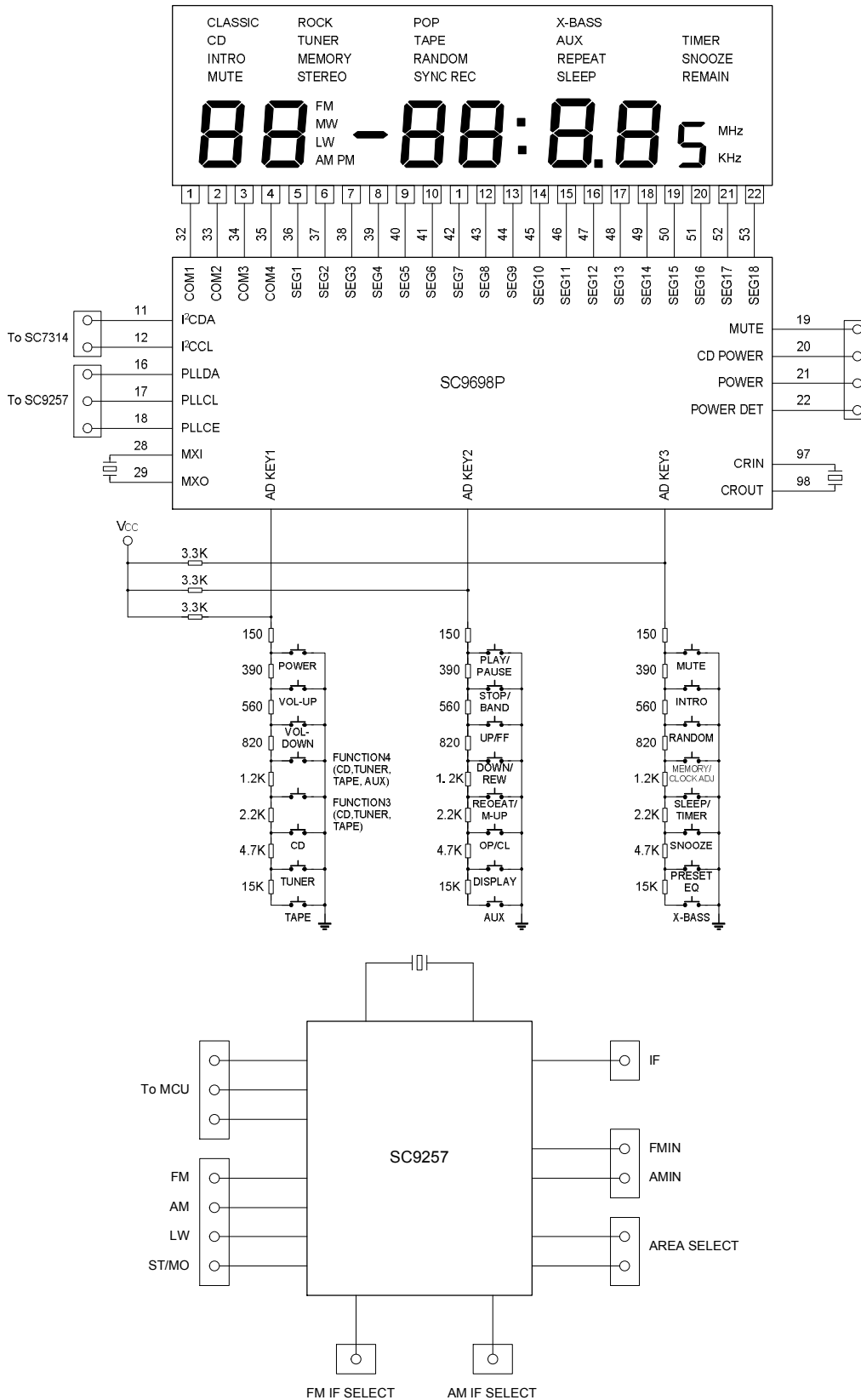

PACKAGE OUTLINE

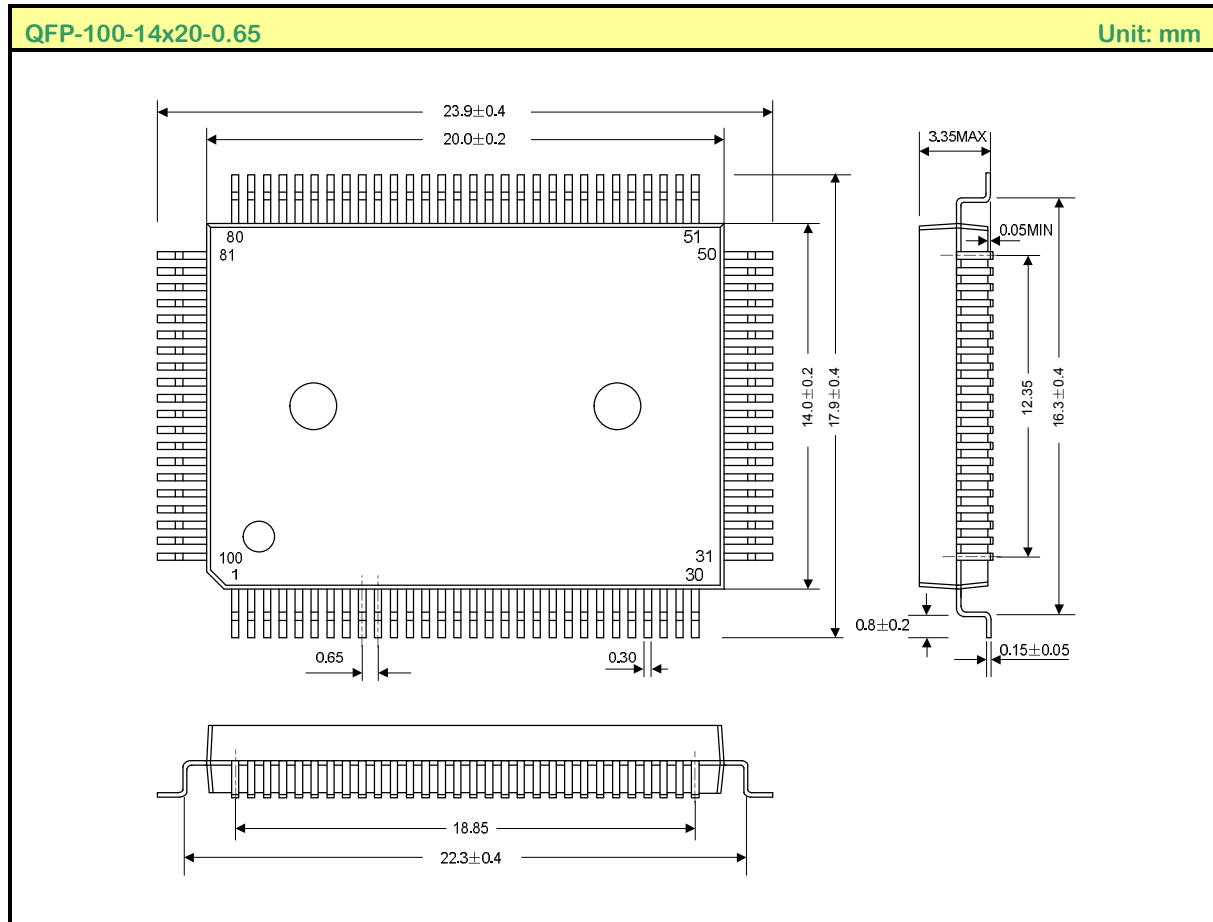

HANDLING MOS DEVICES:

Electrostatic charges can exist in many things. All of our MOS devices are internally protected against electrostatic discharge but they can be damaged if the following precautions are not taken:

- Persons at a work bench should be earthed via a wrist strap.
- Equipment cases should be earthed.
- All tools used during assembly, including soldering tools and solder baths, must be earthed.
- MOS devices should be packed for dispatch in antistatic/conductive containers.

Note: Silan reserves the right to make changes without notice in this specification for the improvement of the design and performance. Silan will supply the best possible product for customers.