

# 1:4 Differential LVDS Fanout Buffer with Selectable Clock Input

## Features

- Select between low-voltage positive emitter-coupled logic (LVPECL) or low-voltage differential signal (LVDS) input pairs to distribute to four LVDS output pairs
- 30-ps maximum output-to-output skew
- 480-ps maximum propagation delay
- 0.11-ps maximum additive RMS phase jitter at 156.25 MHz (12-kHz to 20-MHz offset)
- Up to 1.5-GHz operation
- Output enable and synchronous clock enable functions
- 20-pin thin shrunk small outline package (TSSOP)
- 2.5-V or 3.3-V operating voltage<sup>[1]</sup>
- Commercial and industrial operating temperature range

## Functional Description

The CY2DL1504 is an ultra-low noise, low-skew, low-propagation delay 1:4 differential LVDS fanout buffer targeted to meet the requirements of high-speed clock distribution applications. The CY2DL1504 can select between LVPECL or LVDS input clock pairs using the IN\_SEL pin. The synchronous clock enable function ensures glitch-free output transitions during enable and disable periods. The output enable function allows the outputs to be asynchronously driven to a high-impedance state. The device has a fully differential internal architecture that is optimized to achieve low-additive jitter and low-skew at operating frequencies of up to 1.5 GHz.

## Logic Block Diagram

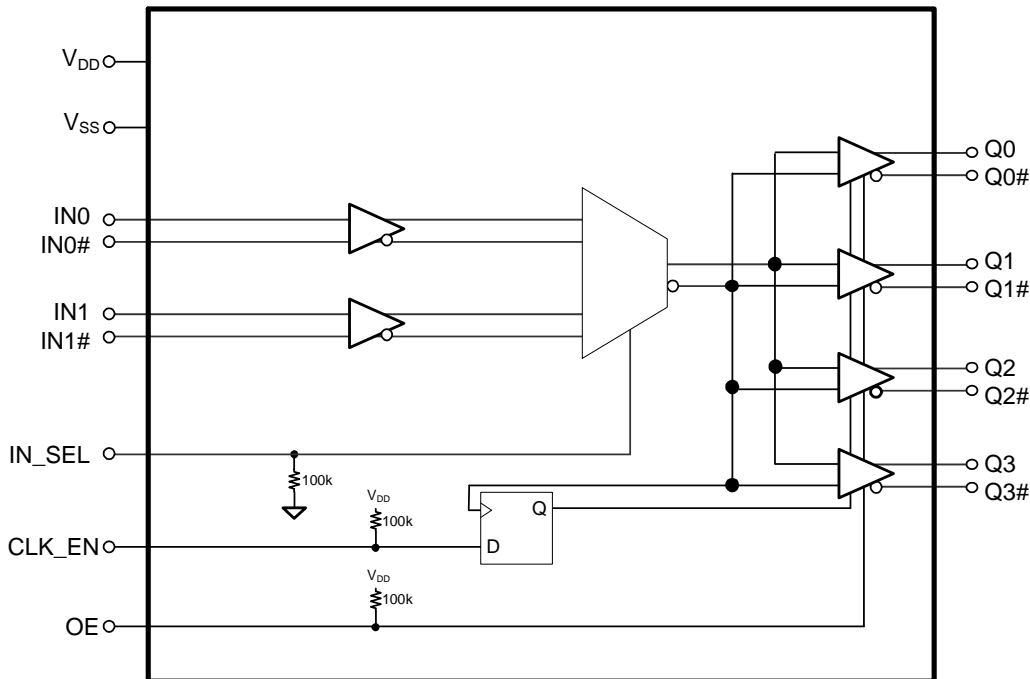

### Note

1. Input AC-coupling capacitors are required for voltage-translation applications.

## Contents

<b>Pinout .....</b>	<b>3</b>	<b>Document Conventions .....</b>	<b>12</b>
<b>Absolute Maximum Ratings .....</b>	<b>4</b>	<b>Document History Page .....</b>	<b>13</b>
<b>Operating Conditions .....</b>	<b>4</b>	<b>Sales, Solutions, and Legal Information .....</b>	<b>15</b>
<b>DC Electrical Specifications .....</b>	<b>5</b>	Worldwide Sales and Design Support .....	15
<b>AC Electrical Specifications .....</b>	<b>6</b>	Products .....	15
<b>Ordering Information.....</b>	<b>10</b>	PSoC Solutions .....	15
Ordering Code Definition.....	10		
<b>Package Diagram.....</b>	<b>11</b>		
<b>Acronyms .....</b>	<b>12</b>		

Pinout

Figure 1. Pin Diagram – CY2DL1504 20-Pin TSSOP Package

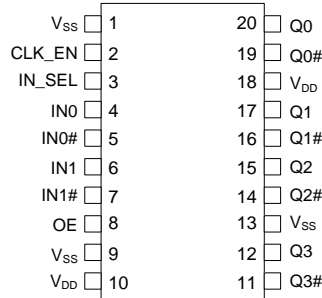

Table 1. Pin Definitions

Pin No.	Pin Name	Pin Type	Description
1,9,13	V <sub>SS</sub>	Power	Ground
2	CLK_EN	Input	Synchronous clock enable. Low-voltage complementary metal oxide semiconductor (LVCMOS)/low-voltage transistor-transistor-logic (LVTTTL); When CLK_EN = Low, Q(0:3) outputs are held low and Q(0:3)# outputs are held high
3	IN_SEL	Input	Input clock select pin. LVCMOS/LVTTTL; When IN_SEL = Low, the IN0/IN0# differential input pair is active; When IN_SEL = High, the IN1/IN1# differential input pair is active
4	IN0	Input	LVDS input clock. Active when IN_SEL = Low
5	IN0#	Input	LVDS complementary input clock. Active when IN_SEL = Low
6	IN1	Input	LVPECL input clock. Active when IN_SEL = High
7	IN1#	Input	LVPECL complementary input clock. Active when IN_SEL = High
8	OE	Input	Output enable. LVCMOS/LVTTTL; When OE = Low, Q(0:3) and Q(0:3)# outputs are disabled (see I <sub>OZ</sub> )
10,18	V <sub>DD</sub>	Power	Power supply
11,14,16,19	Q(0:3)#	Output	LVDS complementary output clocks
12,15,17,20	Q(0:3)	Output	LVDS output clocks

### Absolute Maximum Ratings

Parameter	Description	Condition	Min	Max	Unit
$V_{DD}$	Supply voltage	Nonfunctional	-0.5	4.6	V
$V_{IN}^{[2]}$	Input voltage, relative to $V_{SS}$	Nonfunctional	-0.5	lesser of 4.0 or $V_{DD} + 0.4$	V
$V_{OUT}^{[2]}$	DC output or I/O voltage, relative to $V_{SS}$	Nonfunctional	-0.5	lesser of 4.0 or $V_{DD} + 0.4$	V
$T_S$	Storage temperature	Nonfunctional	-55	150	°C
ESD <sub>HBM</sub>	Electrostatic discharge (ESD) protection (Human body model)	JEDEC STD 22-A114-B	2000	-	V
$L_U$	Latch up		Meets or exceeds JEDEC Spec JESD78B IC Latchup Test		
UL-94	Flammability rating	At 1/8 in.	V-0		
MSL	Moisture sensitivity level		3		

### Operating Conditions

Parameter	Description	Condition	Min	Max	Unit
$V_{DD}$	Supply voltage	2.5-V supply	2.375	2.625	V
		3.3-V supply	3.135	3.465	V
$T_A$	Ambient operating temperature	Commercial	0	70	°C
		Industrial	-40	85	°C
$t_{PU}$	Power ramp time	Power-up time for $V_{DD}$ to reach minimum specified voltage. (Power ramp must be monotonic)	0.05	500	ms

**Note**

2. The voltage on any I/O pin cannot exceed the power pin during power-up. Power supply sequencing is not required.

## DC Electrical Specifications

( $V_{DD} = 3.3\text{ V} \pm 5\%$  or  $2.5\text{ V} \pm 5\%$ ;  $T_A = 0\text{ }^\circ\text{C}$  to  $70\text{ }^\circ\text{C}$  (Commercial) or  $-40\text{ }^\circ\text{C}$  to  $85\text{ }^\circ\text{C}$  (Industrial))

Parameter	Description	Condition	Min	Max	Unit
$I_{DD}$	Operating supply current	All LVDS outputs terminated with a load of $100\ \Omega$ <sup>[3, 4]</sup>	–	61	mA
$V_{IH1}$	Input high voltage, LVDS and LVPECL input clocks, IN0, IN0#, IN1, and IN1#		–	$V_{DD} + 0.3$	V
$V_{IL1}$	Input low voltage, LVDS and LVPECL input clocks, IN0, IN0#, IN1, and IN1#		–0.3	–	V
$V_{IH2}$	Input high voltage, CLK_EN, IN_SEL, and OE	$V_{DD} = 3.3\text{ V}$	2.0	$V_{DD} + 0.3$	V
$V_{IL2}$	Input low voltage, CLK_EN, IN_SEL, and OE	$V_{DD} = 3.3\text{ V}$	–0.3	0.8	V
$V_{IH3}$	Input high voltage, CLK_EN, IN_SEL, and OE	$V_{DD} = 2.5\text{ V}$	1.7	$V_{DD} + 0.3$	V
$V_{IL3}$	Input low voltage, CLK_EN, IN_SEL, and OE	$V_{DD} = 2.5\text{ V}$	–0.3	0.7	V
$V_{ID\_LVDS}$ <sup>[5]</sup>	LVDS input differential amplitude	See Figure 3 on page 7	0.4	0.8	V
$V_{ID\_LVPECL}$ <sup>[5]</sup>	LVPECL input differential amplitude	See Figure 3 on page 7	0.4	1.0	V
$V_{ICM}$	Input common mode voltage	See Figure 3 on page 7	0.5	$V_{DD} - 0.2$	V
$I_{IH}$	Input high current, All inputs	Input = $V_{DD}$ <sup>[6]</sup>	–	150	$\mu\text{A}$
$I_{IL}$	Input low current, All inputs	Input = $V_{SS}$ <sup>[6]</sup>	–150	–	$\mu\text{A}$
$V_{PP}$	LVDS differential output voltage peak to Peak, Single-ended	$V_{DD} = 3.3\text{ V}$ or $2.5\text{ V}$ , $R_{TERM} = 100\ \Omega$ between Q and Q# pairs <sup>[3, 7]</sup>	250	470	mV
$V_{OCM}$	LVDS differential output common mode voltage	$V_{DD} = 3.3\text{ V}$ or $2.5\text{ V}$ , $R_{TERM} = 100\ \Omega$ between Q and Q# pairs <sup>[3, 7]</sup>	1.125	1.375	V
$\Delta V_{OCM}$	Change in $V_{OCM}$ between complementary output states	$V_{DD} = 3.3\text{ V}$ or $2.5\text{ V}$ , $R_{TERM} = 100\ \Omega$ between Q and Q# pairs <sup>[3, 7]</sup>	–	50	mV
$I_{OZ}$	Output leakage current	OE = $V_{SS}$ , $V_{OUT} = 0.75\text{V} - 1.75\text{V}$	–15	15	$\mu\text{A}$
$R_P$	Internal pull-up/pull-down resistance, LVCMOS logic inputs	CLK_EN has pull-up only IN_SEL has pull-down only OE has pull-up only	60	140	k $\Omega$
$C_{IN}$	Input capacitance	Measured at 10 MHz; per pin	–	3	pF

### Notes

- Refer to Figure 2 on page 7.
- $I_{DD}$  includes current that is dissipated externally in the output termination resistors.
- $V_{ID}$  minimum of 400 mV is required to meet all output AC Electrical Specifications. The device is functional with  $V_{ID}$  minimum of greater than 200 mV.
- Positive current flows into the input pin, negative current flows out of the input pin.
- Refer to Figure 4 on page 7.

## AC Electrical Specifications

( $V_{DD} = 3.3\text{ V} \pm 5\%$  or  $2.5\text{ V} \pm 5\%$ ;  $T_A = 0\text{ }^\circ\text{C}$  to  $70\text{ }^\circ\text{C}$  (Commercial) or  $-40\text{ }^\circ\text{C}$  to  $85\text{ }^\circ\text{C}$  (Industrial))

Parameter	Description	Condition	Min	Typ	Max	Unit
$F_{IN}$	Input frequency		DC	–	1.5	GHz
$F_{OUT}$	Output frequency	$F_{OUT} = F_{IN}$	DC	–	1.5	GHz
$t_{PD}^{[8]}$	Propagation delay input pair to output pair	Input rise/fall time < 1.5 ns (20% to 80%)	–	–	480	ps
$t_{ODC}^{[9]}$	Output duty cycle	Diff input at 50% duty cycle Frequency range up to 1 GHz	48	–	52	%
$t_{SK1}^{[10]}$	Output-to-output skew	Any output to any output, with same load conditions at DUT	–	–	30	ps
$t_{SK1D}^{[10]}$	Device-to-device output skew	Any output to any output between two or more devices. Devices must have the same input and have the same output load.	–	–	150	ps
$PN_{ADD}$	Additive RMS phase noise 156.25 MHz Input Rise/fall time < 150 ps (20% to 80%) $V_{ID} > 400\text{ mV}$	Offset = 1 kHz	–	–	–120	dBc/Hz
		Offset = 10 kHz	–	–	–135	dBc/Hz
		Offset = 100 kHz	–	–	–135	dBc/Hz
		Offset = 1 MHz	–	–	–150	dBc/Hz
		Offset = 10 MHz	–	–	–154	dBc/Hz
		Offset = 20 MHz	–	–	–155	dBc/Hz
$t_{JIT}^{[11]}$	Additive RMS phase jitter (Random)	156.25 MHz, 12 kHz to 20 MHz offset; input rise/fall time < 150 ps (20% to 80%), $V_{ID} > 400\text{ mV}$	–	–	0.11	ps
$t_R, t_F^{[12]}$	Output rise/fall time, single-ended	50% duty cycle at input, 20% to 80% of full swing ( $V_{OL}$ to $V_{OH}$ ) Input rise/fall time < 1.5 ns (20% to 80%) Measured at 1 GHz.	–	–	300	ps
$t_{SOD}$	Time from clock edge to outputs disabled	Synchronous clock enable (CLK_EN) switched low	–	–	700	ps
$t_{SOE}$	Time from clock edge to outputs enabled	Synchronous clock enable (CLK_EN) switched high	–	–	700	ps

### Notes

8. Refer to [Figure 5](#) on page 7.
9. Refer to [Figure 6](#) on page 7.
10. Refer to [Figure 7](#) on page 8.
11. Refer to [Figure 8](#) on page 8.
12. Refer to [Figure 9](#) on page 8.

Figure 2. LVDS Output Termination

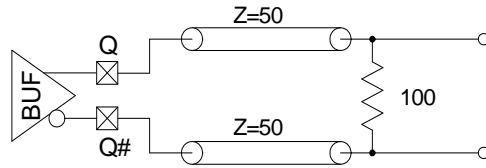

Figure 3. Input Differential and Common Mode Voltages

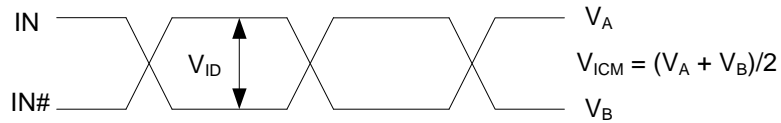

Figure 4. Output Differential and Common Mode Voltages

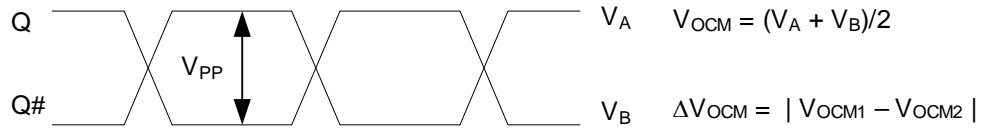

Figure 5. Input to Any Output Pair Propagation Delay

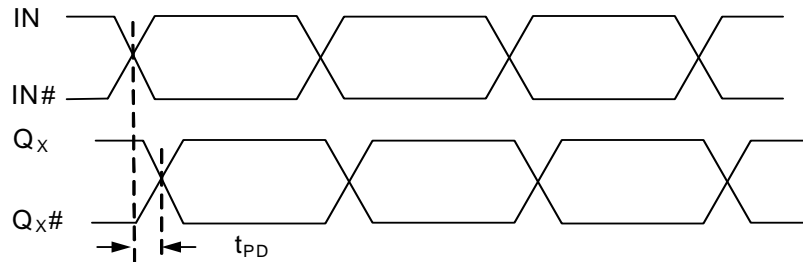

Figure 6. Output Duty Cycle

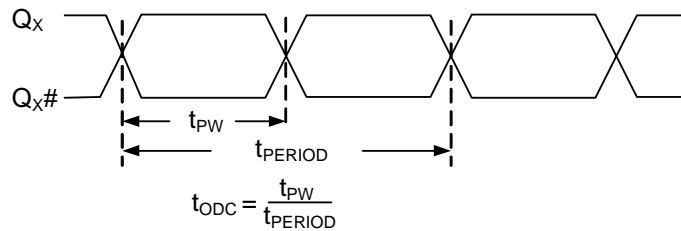

Figure 7. Output-to-output and Device-to-device Skew

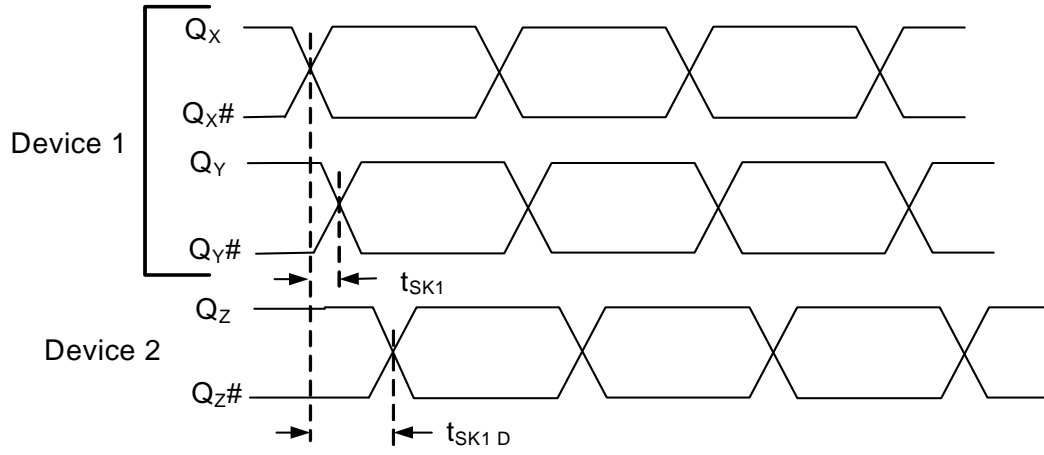

Figure 8. RMS Phase Jitter

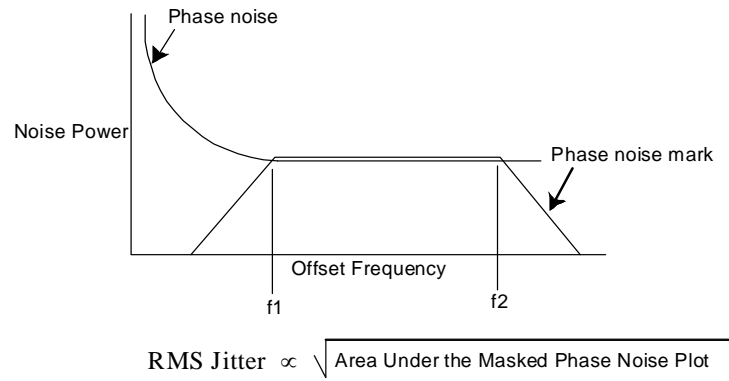

Figure 9. Output Rise/Fall Time

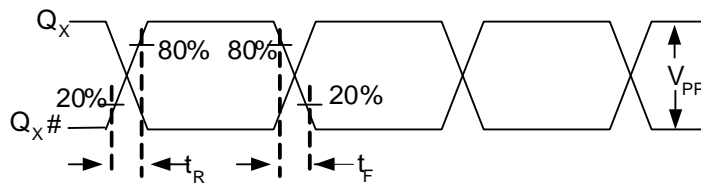
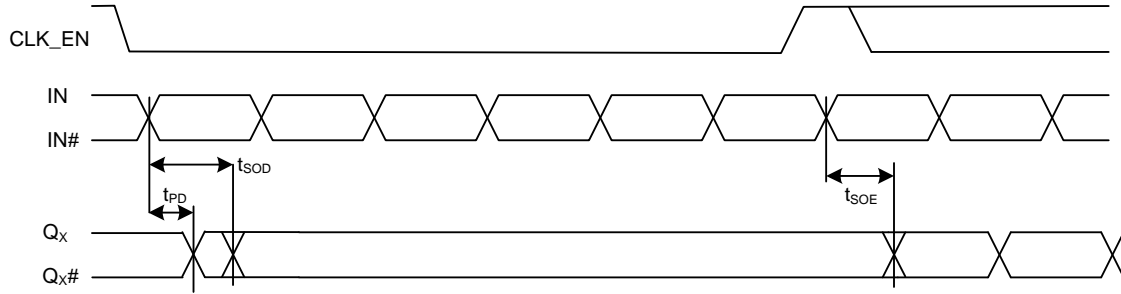



Figure 10. Synchronous Clock Enable Timing



### Ordering Information

Part Number	Type	Production Flow
<b>Pb-free</b>		
CY2DL1504ZXC	20-Pin TSSOP	Commercial, 0 °C to 70 °C
CY2DL1504ZXCT	20-Pin TSSOP	Commercial, 0 °C to 70 °C
CY2DL1504ZXI	20-Pin TSSOP	Industrial, -40 °C to 85 °C
CY2DL1504ZXIT	20-Pin TSSOP	Industrial, -40 °C to 85 °C

### Ordering Code Definition

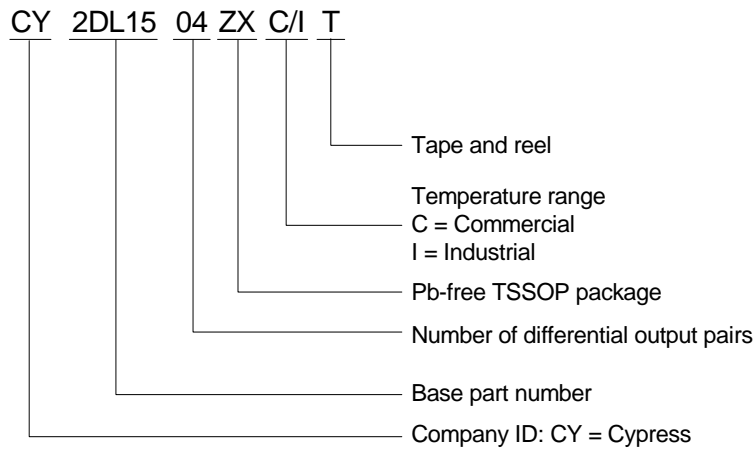

Package Diagram

Figure 11. 20-Pin Thin Shrunk Small Outline Package (4.40 mm Body) ZZ20

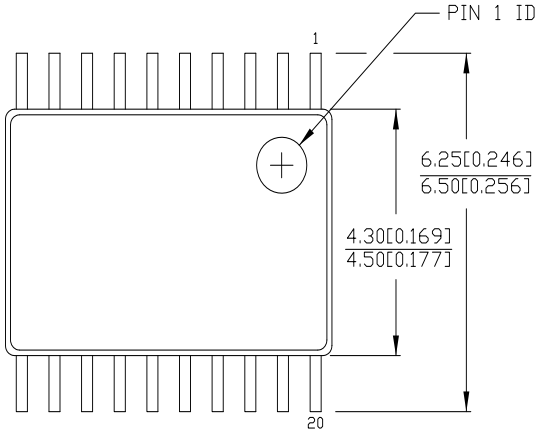

DIMENSIONS IN MM[INCHES] MIN. MAX.  
 REFERENCE JEDEC MO-153

PART #	
Z20.173	STANDARD PKG.
ZZ20.173	LEAD FREE PKG.

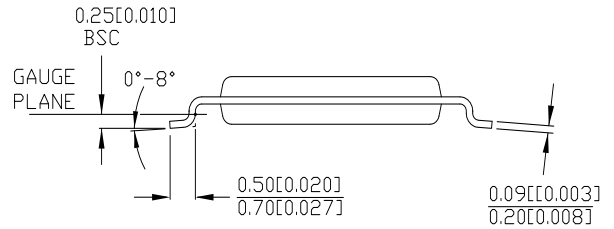
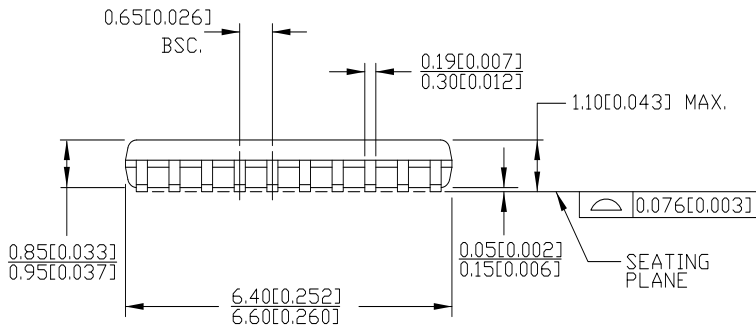

51-85118 °C

## Acronyms

Table 2. Acronyms Used in this Document

Acronym	Description
ESD	Electrostatic discharge
HBM	Human body model
JEDEC	Joint electron devices engineering council
LVDS	Low-voltage differential signal
LVC MOS	Low-voltage complementary metal oxide semiconductor
LVPECL	Low-voltage positive emitter-coupled logic
LVTTTL	Low-voltage transistor-transistor logic
OE	Output enable
RMS	Root mean square
TSSOP	Thin shrunk small outline package

## Document Conventions

Table 3. Units of Measure

Symbol	Unit of Measure
°C	degree Celsius
dBc	decibels relative to the carrier
GHz	giga hertz
Hz	hertz
kΩ	kilo ohm
μA	micro amperes
μF	micro Farad
μs	micro second
mA	milliamperes
ms	millisecond
mV	millivolt
MHz	megahertz
ns	nano second
Ω	ohm
pF	pico Farad
ps	pico second
V	volts
W	watts

Document History Page

Document Title: CY2DL1504 1:4 Differential LVDS Fanout Buffer with Selectable Clock Input				
Document Number: 001-56312				
Revision	ECN	Orig. of Change	Submission Date	Description of Change
**	2782891	CXQ	10/09/09	New Datasheet.
*A	2838613	CXQ	01/05/2010	<p>Changed status from "ADVANCE" to "PRELIMINARY".</p> <p>Changed from 0.34 ps to 0.25 ps maximum additive jitter in "Features" on page 1 and in <math>t_{JIT}</math> in the AC Electrical Specs table on page 5.</p> <p>Added <math>t_{PU}</math> spec to the Operating Conditions table on page 3.</p> <p>Changed max <math>I_{DD}</math> spec in the DC Electrical Specs table on page 4 from 60 mA to 61 mA.</p> <p>Removed <math>V_{OD}</math> and <math>\Delta V_{OD}</math> specs from the DC Electrical Specs table on page 4.</p> <p>Changed <math>I_{OZ}</math> in the DC Electrical Specs table on page 4 from min of -10 uA to -15 uA and from max of 10 uA to 15 uA.</p> <p>Added <math>R_P</math> spec in the DC Electrical Specs table on page 4. Min = 60 k<math>\Omega</math>, Max = 140 k<math>\Omega</math>.</p> <p>Added a measurement definition for <math>C_{IN}</math> in the DC Electrical Specs table on page 4.</p> <p>Added <math>V_{PP}</math> and <math>\Delta V_{PP}</math> specs to the AC Electrical Specs table on page 5. <math>V_{PP}</math> min = 250 mV and max = 470 mV; <math>\Delta V_{PP}</math> max = 50 mV.</p> <p>Changed letter case and some names of all the timing parameters in the AC Electrical Specs table on page 5 to be consistent with EROS.</p> <p>Lowered all additive phase noise mask specs by 3 dB in the AC Electrical Specs table on page 5.</p> <p>Added condition to <math>t_R</math> and <math>t_F</math> specs in the AC Electrical specs table on page 5 that input rise/fall time must be less than 1.5 ns (20% to 80%).</p> <p>Changed letter case and some names of all the timing parameters in Figures 4, 5, 6, 7 and 9, to be consistent with EROS. Updated Figure 4 with definition for <math>V_{PP}</math> and <math>\Delta V_{PP}</math>.</p>
*B	3010332	CXQ	08/18/2010	<p>Changed from 0.25 ps to 0.11 ps maximum additive jitter in "Features" on page 1 and in <math>t_{JIT}</math> in the AC Electrical Specs table on page 5.</p> <p>Added "Functional equivalent to ICS8543i" to the "Features" section.</p> <p>Changed pin 13 in Figure 1 and Table 1 from <math>V_{DD}</math> to <math>V_{SS}</math>.</p> <p>Changed pin 8 description in Table 1 from "high impedance" to "disabled".</p> <p>Added note 6 to describe <math>I_{IH}</math> and <math>I_{IL}</math> specs.</p> <p>Removed reference to data distribution from "Functional Description".</p> <p>Changed <math>R_P</math> for diff inputs from 100 k<math>\Omega</math> to 150 k<math>\Omega</math> in the Logic Block Diagram and from 60 k<math>\Omega</math> min / 140 k<math>\Omega</math> max to 90 k<math>\Omega</math> min / 210 k<math>\Omega</math> max in the DC Electrical Specs table.</p> <p>Split <math>V_{ID}</math> into separate specs in DC Electrical Specs table: 0.4 V min and 0.8 V max for LVDS, 0.4 V min and 1.0 V max for LVPECL.</p> <p>Updated phase noise specs for 1 k/10 k/100 k/1 M/10 M/20 MHz offset to -120/-130/-135/-150/-150/-150dBc/Hz, respectively, in the AC Electrical Specs table.</p> <p>Added "Frequency range up to 1 GHz" condition to <math>t_{ODC}</math> spec.</p> <p>Changed <math>t_{OD}</math> in the AC Electrical Specs table from 3 ns max to 5 ns max.</p> <p>Added Acronyms and Ordering Code Definition.</p>

Document Title: CY2DL1504 1:4 Differential LVDS Fanout Buffer with Selectable Clock Input  
 Document Number: 001-56312

Revision	ECN	Orig. of Change	Submission Date	Description of Change
*C	3090644	CXQ	11/19/2010	<p>Changed <math>V_{IN}</math> and <math>V_{OUT}</math> specs from 4.0V to "lesser of 4.0 or <math>V_{DD} + 0.4</math>"</p> <p>Removed 200mA min LU spec, replaced with "Meets or exceeds JEDEC Spec JESD78B IC Latchup Test"</p> <p>Added "<math>V_{OUT} = 0.75V - 1.75V</math>" to <math>I_{OZ}</math> comments.</p> <p>Moved <math>V_{PP}</math> from AC spec table to DC spec table, removed <math>\Delta V_{PP}</math>.</p> <p>Removed <math>R_P</math> spec for differential input clock pins <math>IN_X</math> and <math>IN_X\#</math>.</p> <p>Changed <math>C_{IN}</math> condition to "Measured at 10 MHz".</p> <p>Changed <math>PN_{ADD}</math> specs for 10kHz, 10MHz, and 20MHz offsets.</p> <p>Added "Measured at 1 GHz" to <math>t_R</math>, <math>t_F</math> spec condition.</p> <p>Removed specs <math>t_S</math>, <math>t_H</math>, <math>t_{OD}</math>, and <math>t_{OE}</math> from AC spec table.</p> <p>Removed <math>\Delta V_{PP}</math> reference from Figure 4.</p>
*D	3135189	CXQ	01/12/2011	<p>Removed "Preliminary" status heading.</p> <p>Removed "Functional equivalent" bullet on page 1.</p> <p>Added "(see <math>I_{OZ}</math>)" note to pin 8 description in <a href="#">Pin Definitions</a>.</p> <p>Fixed typo and removed resistors from <math>IN_X/IN_X\#</math> in <a href="#">Logic Block Diagram</a>.</p> <p>Added <a href="#">Figure 10</a> to describe <math>T_{SOE}</math> and <math>T_{SOD}</math>.</p>
*E	3090938	CXQ	02/25/11	Post to external web.

## Sales, Solutions, and Legal Information

### Worldwide Sales and Design Support

Cypress maintains a worldwide network of offices, solution centers, manufacturer's representatives, and distributors. To find the office closest to you, visit us at [cypress.com/sales](http://cypress.com/sales).

#### Products

Automotive	<a href="http://cypress.com/go/automotive">cypress.com/go/automotive</a>
Clocks & Buffers	<a href="http://cypress.com/go/clocks">cypress.com/go/clocks</a>
Interface	<a href="http://cypress.com/go/interface">cypress.com/go/interface</a>
Lighting & Power Control	<a href="http://cypress.com/go/powerpsoc">cypress.com/go/powerpsoc</a> <a href="http://cypress.com/go/plc">cypress.com/go/plc</a>
Memory	<a href="http://cypress.com/go/memory">cypress.com/go/memory</a>
Optical & Image Sensing	<a href="http://cypress.com/go/image">cypress.com/go/image</a>
PSoC	<a href="http://cypress.com/go/psoc">cypress.com/go/psoc</a>
Touch Sensing	<a href="http://cypress.com/go/touch">cypress.com/go/touch</a>
USB Controllers	<a href="http://cypress.com/go/USB">cypress.com/go/USB</a>
Wireless/RF	<a href="http://cypress.com/go/wireless">cypress.com/go/wireless</a>

#### PSoC Solutions

[psoc.cypress.com/solutions](http://psoc.cypress.com/solutions)  
PSoC 1 | PSoC 3 | PSoC 5

---

© Cypress Semiconductor Corporation, 2009-2011. The information contained herein is subject to change without notice. Cypress Semiconductor Corporation assumes no responsibility for the use of any circuitry other than circuitry embodied in a Cypress product. Nor does it convey or imply any license under patent or other rights. Cypress products are not warranted nor intended to be used for medical, life support, life saving, critical control or safety applications, unless pursuant to an express written agreement with Cypress. Furthermore, Cypress does not authorize its products for use as critical components in life-support systems where a malfunction or failure may reasonably be expected to result in significant injury to the user. The inclusion of Cypress products in life-support systems application implies that the manufacturer assumes all risk of such use and in doing so indemnifies Cypress against all charges.

Any Source Code (software and/or firmware) is owned by Cypress Semiconductor Corporation (Cypress) and is protected by and subject to worldwide patent protection (United States and foreign), United States copyright laws and international treaty provisions. Cypress hereby grants to licensee a personal, non-exclusive, non-transferable license to copy, use, modify, create derivative works of, and compile the Cypress Source Code and derivative works for the sole purpose of creating custom software and or firmware in support of licensee product to be used only in conjunction with a Cypress integrated circuit as specified in the applicable agreement. Any reproduction, modification, translation, compilation, or representation of this Source Code except as specified above is prohibited without the express written permission of Cypress.

Disclaimer: CYPRESS MAKES NO WARRANTY OF ANY KIND, EXPRESS OR IMPLIED, WITH REGARD TO THIS MATERIAL, INCLUDING, BUT NOT LIMITED TO, THE IMPLIED WARRANTIES OF MERCHANTABILITY AND FITNESS FOR A PARTICULAR PURPOSE. Cypress reserves the right to make changes without further notice to the materials described herein. Cypress does not assume any liability arising out of the application or use of any product or circuit described herein. Cypress does not authorize its products for use as critical components in life-support systems where a malfunction or failure may reasonably be expected to result in significant injury to the user. The inclusion of Cypress' product in a life-support systems application implies that the manufacturer assumes all risk of such use and in doing so indemnifies Cypress against all charges.

Use may be limited by and subject to the applicable Cypress software license agreement.