

# BFP720

SiGe:C Heterojunction Wideband RF Bipolar Transistor

## Data Sheet

Revision 1.0, 2009-01-20

**Edition 2009-01-20**

**Published by  
Infineon Technologies AG  
81726 Munich, Germany**

**© 2010 Infineon Technologies AG  
All Rights Reserved.**

### **Legal Disclaimer**

The information given in this document shall in no event be regarded as a guarantee of conditions or characteristics. With respect to any examples or hints given herein, any typical values stated herein and/or any information regarding the application of the device, Infineon Technologies hereby disclaims any and all warranties and liabilities of any kind, including without limitation, warranties of non-infringement of intellectual property rights of any third party.

### **Information**

For further information on technology, delivery terms and conditions and prices, please contact the nearest Infineon Technologies Office ([www.infineon.com](http://www.infineon.com)).

### **Warnings**

Due to technical requirements, components may contain dangerous substances. For information on the types in question, please contact the nearest Infineon Technologies Office.

Infineon Technologies components may be used in life-support devices or systems only with the express written approval of Infineon Technologies, if a failure of such components can reasonably be expected to cause the failure of that life-support device or system or to affect the safety or effectiveness of that device or system. Life support devices or systems are intended to be implanted in the human body or to support and/or maintain and sustain and/or protect human life. If they fail, it is reasonable to assume that the health of the user or other persons may be endangered.

**BFP720 SiGe:C Heterojunction Wideband RF Bipolar Transistor**

**Revision History: 2009-01-20, Revision 1.0**

**Previous Revision:**

Page	Subjects (major changes since last revision)
	Converted to the new IFX Template.
	Business Unit, Infineon Logo and the Trademarks were changed.

**Trademarks of Infineon Technologies AG**

A-GOLD™, BlueMoon™, COMNEON™, CONVERGATE™, COSIC™, C166™, CROSSAVE™, CanPAK™, CIPOS™, CoolMOS™, CoolSET™, CONVERPATH™, CORECONTROL™, DAVE™, DUALFALC™, DUSLIC™, EasyPIM™, EconoBRIDGE™, EconoDUAL™, EconoPACK™, EconoPIM™, E-GOLD™, EiceDRIVER™, EUPEC™, ELIC™, EPIC™, FALC™, FCOS™, FLEXISLIC™, GEMINAX™, GOLDMOS™, HITFET™, HybridPACK™, INCA™, ISAC™, ISOFACE™, IsoPACK™, IWORX™, M-GOLD™, MIPAQ™, ModSTACK™, MUSLIC™, my-d™, NovalithIC™, OCTALFALC™, OCTAT™, OmniTune™, OmniVia™, OptiMOS™, OPTIVERSE™, ORIGAT™, PROFET™, PRO-SIL™, PrimePACK™, QUADFALC™, RASIC™, ReverSave™, SatRIC™, SCEPTRE™, SCOUT™, S-GOLD™, SensoNor™, SEROCCO™, SICOFI™, SIEGET™, SINDRION™, SLIC™, SMARTi™, SmartLEWIS™, SMINT™, SOCRATES™, TEMPFET™, thinQ!™, TrueENTRY™, TriCore™, TRENCHSTOP™, VINAX™, VINETIC™, VIONTIC™, WildPass™, X-GOLD™, XMM™, X-PMU™, XPOSYS™, XWAY™.

**Other Trademarks**

AMBA™, ARM™, MULTI-ICE™, PRIMECELL™, REALVIEW™, THUMB™ of ARM Limited, UK. AUTOSAR™ is licensed by AUTOSAR development partnership. Bluetooth™ of Bluetooth SIG Inc. CAT-iq™ of DECT Forum. COLOSSUS™, FirstGPS™ of Trimble Navigation Ltd. EMV™ of EMVCo, LLC (Visa Holdings Inc.). EPCOS™ of Epcos AG. FLEXGO™ of Microsoft Corporation. FlexRay™ is licensed by FlexRay Consortium. HYPERTERMINAL™ of Hilgraeve Incorporated. IEC™ of Commission Electrotechnique Internationale. IrDA™ of Infrared Data Association Corporation. ISO™ of INTERNATIONAL ORGANIZATION FOR STANDARDIZATION. MATLAB™ of MathWorks, Inc. MAXIM™ of Maxim Integrated Products, Inc. MICROTEC™, NUCLEUS™ of Mentor Graphics Corporation. Mifare™ of NXP. MIPI™ of MIPI Alliance, Inc. MIPS™ of MIPS Technologies, Inc., USA. muRata™ of MURATA MANUFACTURING CO. OmniVision™ of OmniVision Technologies, Inc. Openwave™ Openwave Systems Inc. RED HAT™ Red Hat, Inc. RFMD™ RF Micro Devices, Inc. SIRIUS™ of Sirius Sattelite Radio Inc. SOLARIS™ of Sun Microsystems, Inc. SPANSION™ of Spansion LLC Ltd. Symbian™ of Symbian Software Limited. TAIYO YUDEN™ of Taiyo Yuden Co. TEAKLITE™ of CEVA, Inc. TEKTRONIX™ of Tektronix Inc. TOKO™ of TOKO KABUSHIKI KAISHA TA. UNIX™ of X/Open Company Limited. VERILOG™, PALLADIUM™ of Cadence Design Systems, Inc. VLYNQ™ of Texas Instruments Incorporated. VXWORKS™, WIND RIVER™ of WIND RIVER SYSTEMS, INC. ZETEX™ of Diodes Zetex Limited.

Last Trademarks Update 2009-10-19

## Table of Contents

	<b>Table of Contents</b> .....	4
	<b>List of Figures</b> .....	5
	<b>List of Tables</b> .....	6
<b>1</b>	<b>Features</b> .....	7
<b>2</b>	<b>Product Brief</b> .....	8
<b>3</b>	<b>Maximum Ratings</b> .....	10
<b>4</b>	<b>Thermal Characteristics</b> .....	11
<b>5</b>	<b>Electrical Characteristics</b> .....	13
5.1	DC Characteristics .....	13
5.2	General AC Characteristics .....	13
5.3	Frequency Dependent AC Characteristics .....	14
5.4	Characteristic Curves .....	19
<b>6</b>	<b>Simulation Data</b> .....	24
<b>7</b>	<b>Package Information</b> .....	25

## List of Figures

Figure 1	Total Power Dissipation $P_{\text{tot}} = f(T_s)$ .....	11
Figure 2	Permissible Pulse Load $P_{\text{tot\_max}} / P_{\text{tot\_DC}} = f(\text{tp})$ .....	12
Figure 3	Permissible Pulse Load $R_{\text{thJS}} = f(\text{tp})$ .....	12
Figure 4	BFP720 Testing Circuit. ....	14
Figure 5	Transition Frequency $f_T = f(I_C, V_{\text{CE}})$ $f = 1$ GHz, $V_{\text{CE}}$ Parameter in V .....	19
Figure 6	Power Gain $G_{\text{ma}}, G_{\text{ms}},  S_{21} ^2 = f(f)$ $V_{\text{CE}} = 3$ V, $I_C = 13$ mA .....	19
Figure 7	Input Matching $S_{11}$ vs. Frequency $V_{\text{CE}} = 3$ V, $I_C = 5$ mA / 13 mA .....	20
Figure 8	Output Matching $S_{22}$ vs. Frequency $V_{\text{CE}} = 3$ V, $I_C = 5$ mA / 13 mA .....	20
Figure 9	Source Impedance $Z_{\text{opt}}$ for $NF_{\text{min}}$ vs. Frequency $V_{\text{CE}} = 3$ V, $I_C = 5$ mA / 13 mA .....	21
Figure 10	Noise Figure $NF_{\text{min}} = f(I_C)$ $V_{\text{CE}} = 3$ V, $Z_S = Z_{\text{opt}}$ .....	21
Figure 11	Noise Figure $NF_{\text{min}} = f(f)$ $V_{\text{CE}} = 3$ V, $Z_S = Z_{\text{op}}$ .....	22
Figure 12	Power Gain $G_{\text{ma}}, G_{\text{ms}} = f(I_C)$ $V_{\text{CE}} = 3$ V, $f =$ Parameter in GHz .....	22
Figure 13	Power Gain $G_{\text{ma}}, G_{\text{ms}} = f(V_{\text{CE}})$ $I_C = 13$ mA, $f =$ Parameter in GHz .....	23
Figure 14	Package Outline SOT343 (top / side view). ....	25
Figure 15	Footprint .....	25
Figure 16	Marking Example (Marking BFP720: R9s) .....	25
Figure 17	Tape Dimensions .....	25

## List of Tables

Table 1	Quick Reference DC Characteristics at $T_A = 25^\circ\text{C}$ .....	8
Table 2	Quick Reference AC Characteristics at $T_A = 25^\circ\text{C}$ .....	9
Table 3	Maximum Ratings ( $T_A = 25^\circ\text{C}$ unless otherwise specified) .....	10
Table 4	Thermal Resistance .....	11
Table 5	DC Characteristics at $T_A = 25^\circ\text{C}$ .....	13
Table 6	AC Characteristics at $T_A = 25^\circ\text{C}$ .....	13
Table 7	AC Characteristics, $V_{CE} = 3\text{ V}$ , $f = 150\text{ MHz}$ .....	14
Table 8	AC Characteristics, $V_{CE} = 3\text{ V}$ , $f = 450\text{ MHz}$ .....	15
Table 9	AC Characteristics, $V_{CE} = 3\text{ V}$ , $f = 900\text{ MHz}$ .....	15
Table 10	AC Characteristics, $V_{CE} = 3\text{ V}$ , $f = 1500\text{ MHz}$ .....	16
Table 11	AC Characteristics, $V_{CE} = 3\text{ V}$ , $f = 1.9\text{ GHz}$ .....	16
Table 12	AC Characteristics, $V_{CE} = 3\text{ V}$ , $f = 2.4\text{ GHz}$ .....	17
Table 13	AC Characteristics, $V_{CE} = 3\text{ V}$ , $f = 3.5\text{ GHz}$ .....	17
Table 14	AC Characteristics, $V_{CE} = 3\text{ V}$ , $f = 5.5\text{ GHz}$ .....	18
Table 15	AC Characteristics, $V_{CE} = 3\text{ V}$ , $f = 10\text{ GHz}$ .....	18

## 1 Features

Main features:

- High performance general purpose wideband LNA transistor
- 150 GHz  $f_T$ -Silicon Germanium Carbon technology
- Enables Best-In-Class performance for wireless applications due to high dynamic range
- Transistor geometry optimized for low-current applications
- Operation voltage: 1.0 V to 4.0 V
- Very high gain at high frequencies and low current consumption
- 26 dB maximum stable gain at 1.9 GHz and only 13 mA
- 15 dB maximum available gain at 10 GHz and only 13 mA
- Ultra low noise figure from latest SiGe:C technology
- 0.7 dB minimum noise figure at 5.5 GHz and 0.95 dB at 10 GHz
- High linearity OP1dB = +8.5 dBm and OIP3 = +23 dBm at 5.5 GHz and low current consumption of 13 mA
- Pb-free (RoHS compliant) package

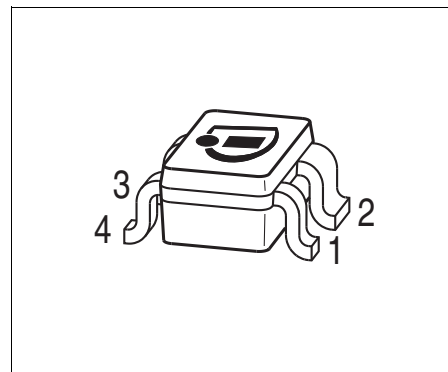

### Application

FM Radio, Mobile TV, RKE, AMR, Cellular, ZigBee, GPS, WiMAX, SDARs, Bluetooth, WiFi, Cordless phone, UMTS, WLAN, UWB, LNB

**Attention: ESD (Electrostatic discharge) sensitive device, observe handling precautions**

Product Name	Package	Pin Configuration				Marking
BFP720	SOT343	1 = B	2 = E	3 = C	4 = E	R9s

## 2 Product Brief

The BFP720 is a wideband Silicon Germanium Carbon (SiGe:C) NPN Heterojunction Bipolar Transistor (HBT) in a plastic 4-pin dual emitter SOT343 package. The device combines very high gain with lowest noise figure at low operating current for use in a wide range of wireless applications. The BFP720 is especially well-suited for portable battery-powered applications in which reduced power consumption is a key requirement. Collector design supports operation voltages from 1.0 V to 4.0 V.

**Table 1 Quick Reference DC Characteristics at  $T_A = 25^\circ\text{C}$**

Parameter	Symbol	Values			Unit	Note / Test Condition
		Min.	Typ.	Max.		
Collector-emitter breakdown voltage	$V_{(BR)CEO}$	4	4.7	–	V	$I_C = 1 \text{ mA}, I_B = 0 \text{ mA}$
Collector-base breakdown voltage	$V_{(BR)CBO}$	13	15	–	V	$I_E = 0 \text{ mA}$
Collector current	$I_C$	–	–	25	mA	
Total power dissipation	$P_{tot}$	–	–	100	mW	$T_S \leq 108^\circ\text{C}$
DC current gain	$h_{FE}$	160	250	400		$V_{CE} = 3 \text{ V}, I_C = 13 \text{ mA}$



**Table 2 Quick Reference AC Characteristics at  $T_A = 25^\circ\text{C}$**

Parameter	Symbol	Values			Unit	Note / Test Condition
		Min.	Typ.	Max.		
Transition frequency	$f_T$	–	45	–	GHz	$V_{CE} = 3\text{ V}, I_C = 13\text{ mA}$
<b><math>f = 2.4\text{ GHz}</math></b>						
<b>Maximum Power Gain</b>		–		–	dB	
Low Noise Operation Point	$G_{ms}$		22			$I_C = 5\text{ mA}$
High Linearity Operation Point	$G_{ms}$		25			$I_C = 13\text{ mA}$
<b>Transducer Gain</b>		–		–	dB	
Low Noise Operation Point	$S_{21}$		20.5			$Z_S = Z_L = 50\ \Omega$ $I_C = 5\text{ mA}$
High Linearity Operation Point	$S_{21}$		23			$I_C = 13\text{ mA}$
<b>Minimum Noise Figure</b>		–		–	dB	
Minimum Noise Figure	$NF_{min}$		0.5			$Z_S = Z_{opt}$ $I_C = 5\text{ mA}$
Associated Gain	$G_{ass}$		21.5			$I_C = 5\text{ mA}$
<b>Linearity</b>		–		–	dBm	
1 dB Gain Compression Point	$OP_{1dB}$		6			$Z_S = Z_L = 50\ \Omega$ $I_C = 13\text{ mA}$
3 <sup>rd</sup> Order Intercept Point	$OIP_3$		22			$I_C = 13\text{ mA}$
<b><math>f = 5.5\text{ GHz}</math></b>						
<b>Maximum Power Gain</b>		–		–	dB	
Low Noise Operation Point	$G_{ms}$		19			$I_C = 5\text{ mA}$
High Linearity Operation Point	$G_{ma}$		19.5			$I_C = 13\text{ mA}$
<b>Transducer Gain</b>		–		–	dB	
Low Noise Operation Point	$S_{21}$		15			$Z_S = Z_L = 50\ \Omega$ $I_C = 5\text{ mA}$
High Linearity Operation Point	$S_{21}$		16			$I_C = 13\text{ mA}$
<b>Minimum Noise Figure</b>		–		–	dB	
Minimum Noise Figure	$NF_{min}$		0.7			$Z_S = Z_{opt}$ $I_C = 5\text{ mA}$
Associated Gain	$G_{ass}$		15			$I_C = 5\text{ mA}$
<b>Linearity</b>		–		–	dBm	
1 dB Gain Compression Point	$OP_{1dB}$		8.5			$Z_S = Z_L = 50\ \Omega$ $I_C = 13\text{ mA}$
3 <sup>rd</sup> Order Intercept Point	$OIP_3$		23			$I_C = 13\text{ mA}$

### 3 Maximum Ratings

**Table 3 Maximum Ratings ( $T_A = 25\text{ °C}$  unless otherwise specified)**

Parameter	Symbol	Values			Unit	Note / Test Condition
		Min.	Typ.	Max.		
Collector-emitter voltage $T_A = -55\text{ °C}$	$V_{CEO}$	–	–	4.0 3.5	V	–
Collector-emitter voltage	$V_{CES}$	–	–	13	V	–
Collector-base voltage	$V_{CBO}$	–	–	13	V	–
Emitter-base voltage	$V_{EBO}$	–	–	1.2	V	–
Collector current	$I_C$	–	–	25	mA	–
Base current	$I_B$	–	–	2	mA	–
Total power dissipation <sup>1)</sup> $T_S \leq 108\text{ °C}$	$P_{tot}$	–	–	100	mW	–
Operation junction temperature	$T_{JOp}$	-55	–	150	°C	–
Storage temperature	$T_{Stg}$	-55	–	150	°C	–

1)  $T_S$  measured on the emitter lead at the soldering point of the pcb

*Note: Exceeding only one of the above maximum rating limits even for a short moment may cause permanent damage to the device. Even if the device continues to operate, its lifetime may be considerably shortened. Maximum ratings are stress ratings only and do not mean unaffected functional operation and lifetime at others than standard operation conditions.*

## 4 Thermal Characteristics

**Table 4 Thermal Resistance**

Parameter	Symbol	Value	Unit
Junction - soldering point <sup>1)</sup>	$R_{thJS}$	420	K/W

1)For calculation of  $R_{thJA}$  please refer to Application Note Thermal Resistance

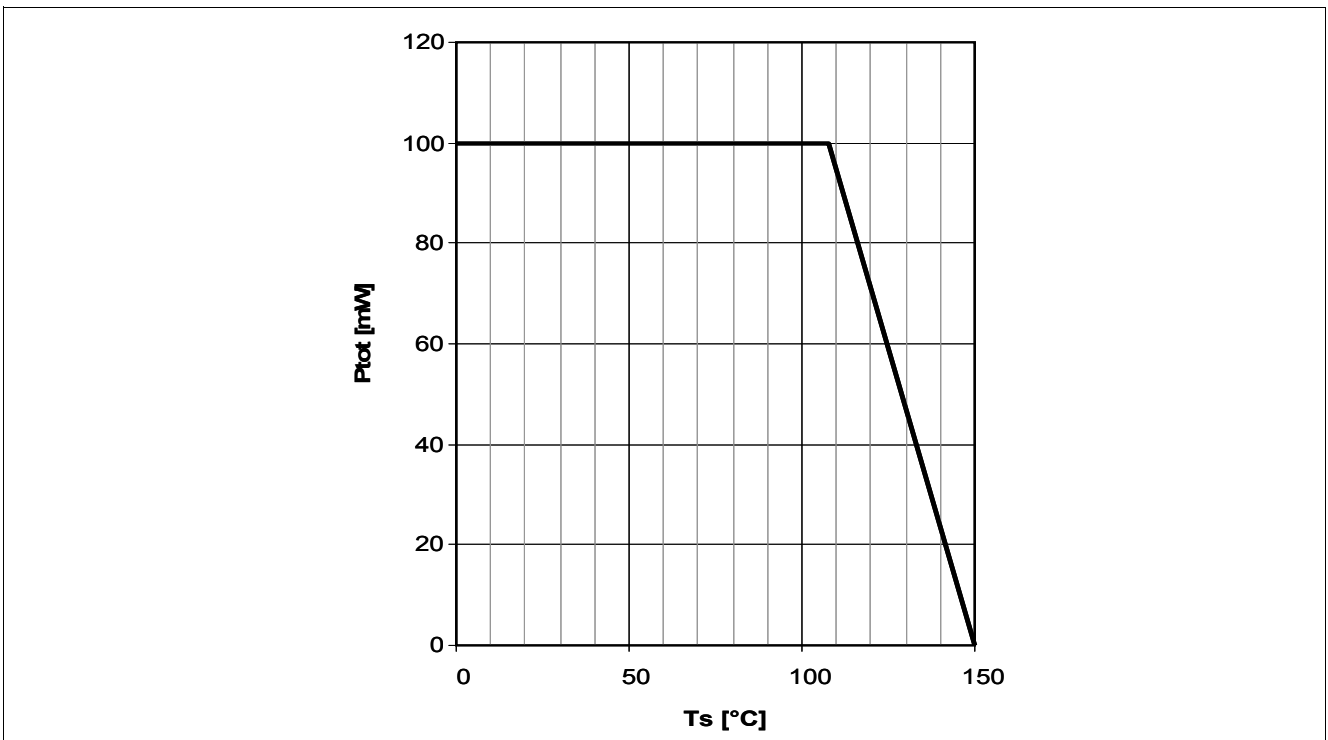

**Figure 1 Total Power Dissipation  $P_{tot} = f(T_s)$**

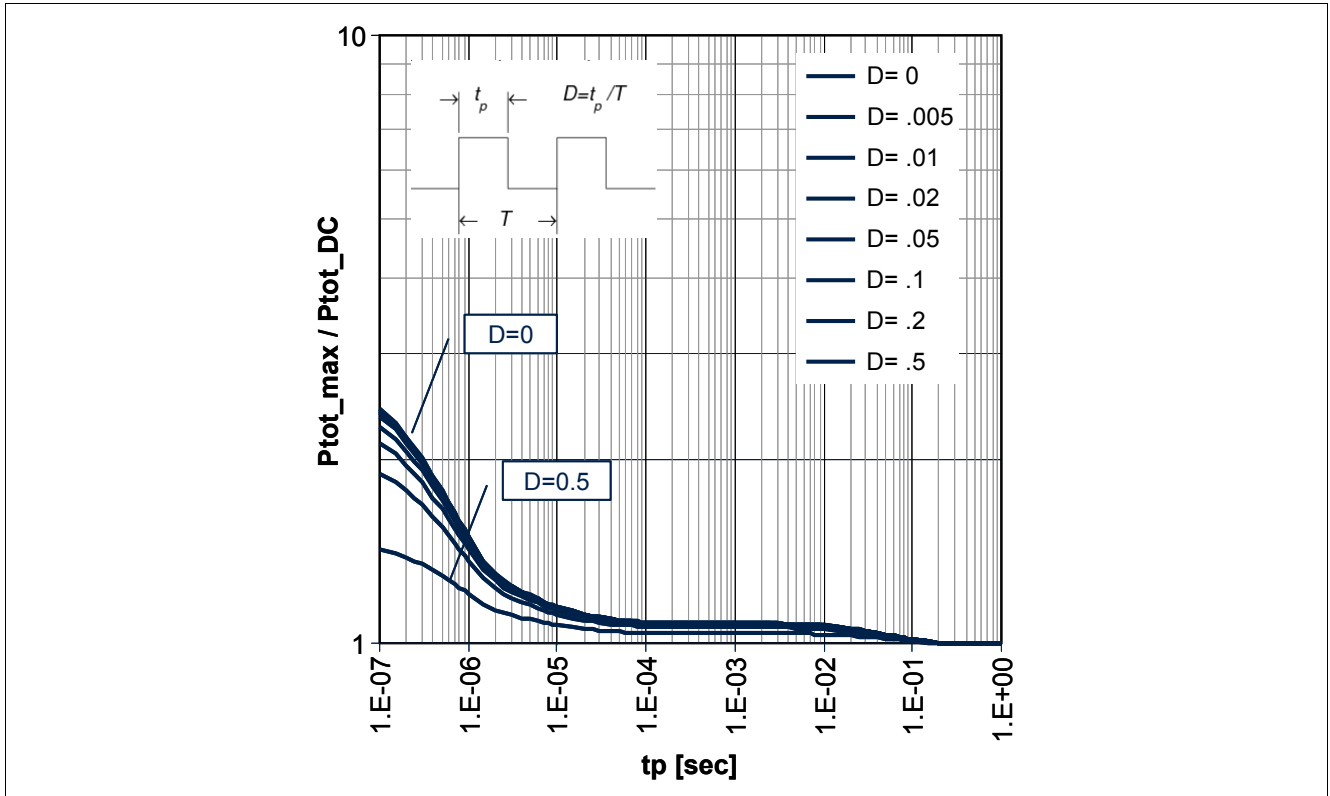

Figure 2 Permissible Pulse Load  $P_{tot\_max} / P_{tot\_DC} = f(t_p)$

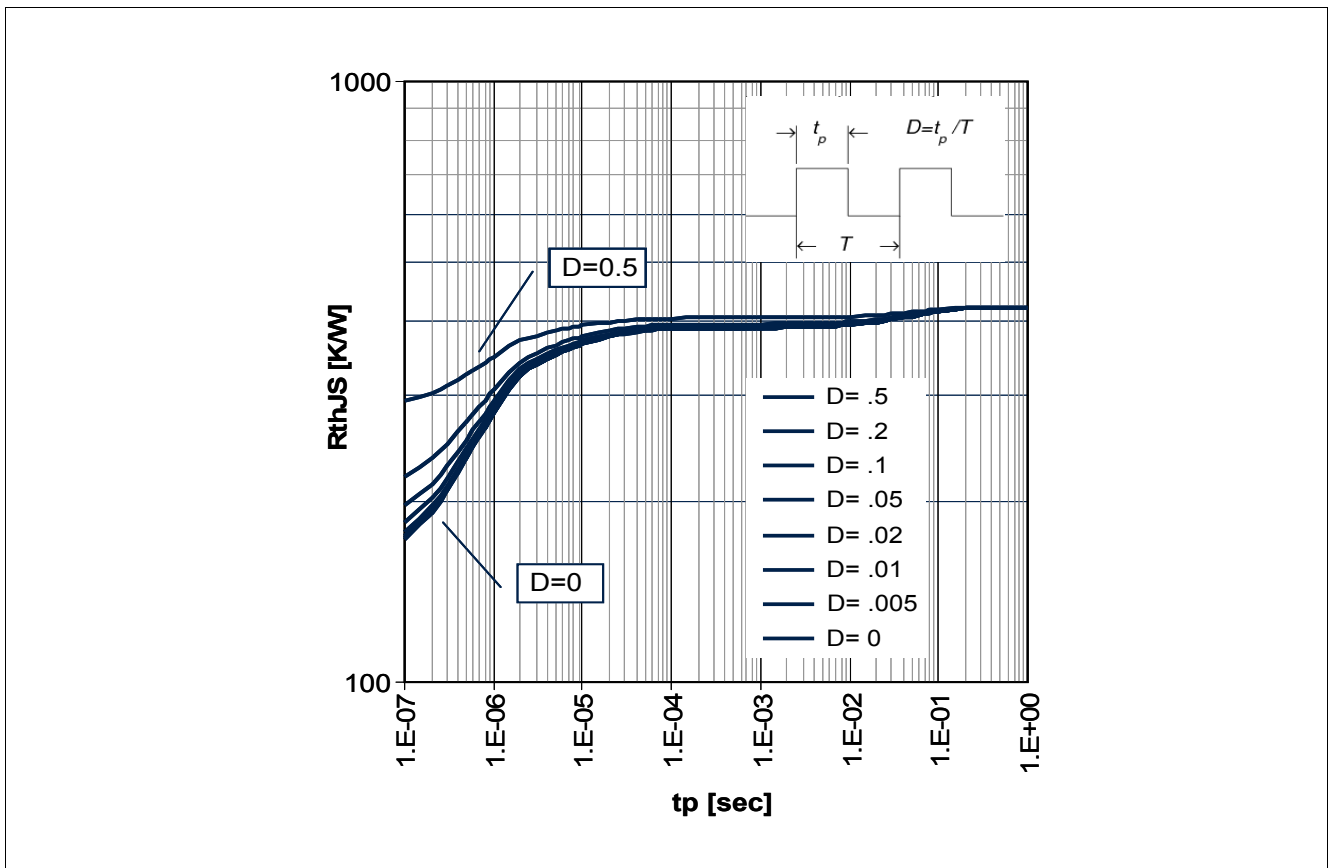

Figure 3 Permissible Pulse Load  $R_{thJS} = f(t_p)$

## 5 Electrical Characteristics

### 5.1 DC Characteristics

**Table 5 DC Characteristics at  $T_A = 25\text{ °C}$** 

Parameter	Symbol	Values			Unit	Note / Test Condition
		Min.	Typ.	Max.		
Collector-emitter breakdown voltage	$V_{(BR)CEO}$	4	4.7	–	V	$I_C = 1\text{ mA}, I_B = 0\text{ mA}$
Collector-emitter cutoff current	$I_{CES}$	–	–	30	$\mu\text{A}$	$V_{CE} = 13\text{ V}, V_{BE} = 0\text{ V}$
Collector-base cutoff current	$I_{CBO}$	–	–	100	nA	$V_{CB} = 5\text{ V}, I_E = 0\text{ mA}$
Emitter-base cutoff current	$I_{EBO}$	–	–	2	$\mu\text{A}$	$V_{EB} = 0.5\text{ V}, I_C = 0\text{ mA}$
DC current gain	$h_{FE}$	160	250	400		$I_C = 13\text{ mA}, V_{CE} = 3\text{ V}$ pulse measured

### 5.2 General AC Characteristics

**Table 6 AC Characteristics at  $T_A = 25\text{ °C}$** 

Parameter	Symbol	Values			Unit	Note / Test Condition
		Min.	Typ.	Max.		
Transition frequency	$f_T$	–	45	–	GHz	$I_C = 13\text{ mA}, V_{CE} = 3\text{ V}$ $f = 1\text{ GHz}$
Collector-base capacitance	$C_{cb}$	–	0.06	–	pF	$V_{CB} = 3\text{ V}, V_{BE} = 0\text{ V}$ $f = 1\text{ MHz}$ emitter grounded
Collector-emitter capacitance	$C_{ce}$	–	0.35	–	pF	$V_{CE} = 3\text{ V}, V_{BE} = 0\text{ V}$ $f = 1\text{ MHz}$ base grounded
Emitter-base capacitance	$C_{eb}$	–	0.35	–	pF	$V_{EB} = 0.5\text{ V}, V_{CB} = 0\text{ V}$ $f = 1\text{ MHz}$ collector grounded

### 5.3 Frequency Dependent AC Characteristics

Measurement setup is a testfixture with Bias T's in a 50 Ω system,  $T_A = 25\text{ °C}$

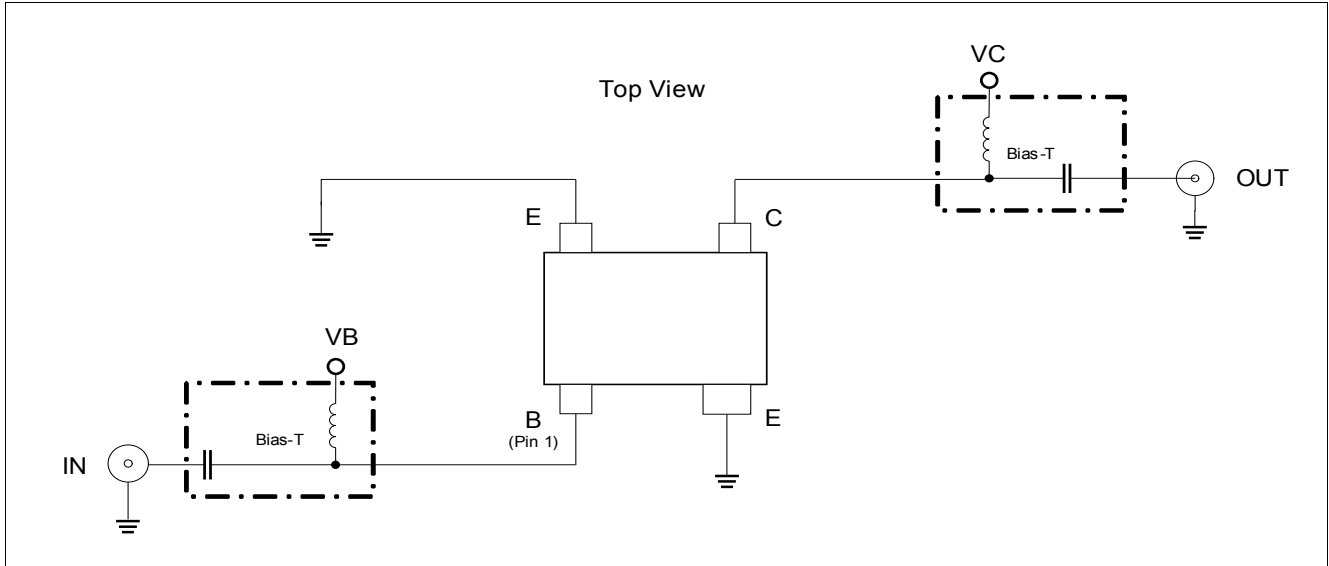

Figure 4 BFP720 Testing Circuit

Table 7 AC Characteristics,  $V_{CE} = 3\text{ V}$ ,  $f = 150\text{ MHz}$

Parameter	Symbol	Values			Unit	Note / Test Condition
		Min.	Typ.	Max.		
<b>Maximum Power Gain</b>						
Low Noise Operation Point	$G_{ms}$	–	34	–	dB	$I_C = 5\text{ mA}$
High Linearity Operation Point	$G_{ms}$		37.5			$I_C = 13\text{ mA}$
<b>Transducer Gain</b>						
Low Noise Operation Point	$S_{21}$	–	23	–	dB	$Z_S = Z_L = 50\text{ }\Omega$ $I_C = 5\text{ mA}$
High Linearity Operation Point	$S_{21}$		29.5			$I_C = 13\text{ mA}$
<b>Minimum Noise Figure</b>						
Minimum Noise Figure	$NF_{min}$	–	0.4	–	dB	$Z_S = Z_{opt}$ $I_C = 5\text{ mA}$
Associated Gain	$G_{ass}$		28.5			$I_C = 5\text{ mA}$
<b>Linearity</b>						
1 dB Gain Compression Point	$OP_{1dB}$	–	6	–	dBm	$Z_S = Z_L = 50\text{ }\Omega$ $I_C = 13\text{ mA}$
3rd Order Intercept Point	$OIP_3$		22			$I_C = 13\text{ mA}$

Table 8 AC Characteristics,  $V_{CE} = 3\text{ V}$ ,  $f = 450\text{ MHz}$ 

Parameter	Symbol	Values			Unit	Note / Test Condition
		Min.	Typ.	Max.		
<b>Maximum Power Gain</b>		–		–	dB	
Low Noise Operation Point	$G_{ms}$		29			$I_C = 5\text{ mA}$
High Linearity Operation Point	$G_{ms}$		32.5			$I_C = 13\text{ mA}$
<b>Transducer Gain</b>		–		–	dB	$Z_S = Z_L = 50\ \Omega$
Low Noise Operation Point	$S_{21}$		23			$I_C = 5\text{ mA}$
High Linearity Operation Point	$S_{21}$		28.5			$I_C = 13\text{ mA}$
<b>Minimum Noise Figure</b>		–		–	dB	$Z_S = Z_{opt}$
Minimum Noise Figure	$NF_{min}$		0.4			$I_C = 5\text{ mA}$
Associated Gain	$G_{ass}$		28			$I_C = 5\text{ mA}$
<b>Linearity</b>		–		–	dBm	$Z_S = Z_L = 50\ \Omega$
1 dB Gain Compression Point	$OP_{1dB}$		5.5			$I_C = 13\text{ mA}$
3 <sup>rd</sup> Order Intercept Point	$OIP_3$		21.5			$I_C = 13\text{ mA}$

 Table 9 AC Characteristics,  $V_{CE} = 3\text{ V}$ ,  $f = 900\text{ MHz}$ 

Parameter	Symbol	Values			Unit	Note / Test Condition
		Min.	Typ.	Max.		
<b>Maximum Power Gain</b>		–		–	dB	
Low Noise Operation Point	$G_{ms}$		26.5			$I_C = 5\text{ mA}$
High Linearity Operation Point	$G_{ms}$		29.5			$I_C = 13\text{ mA}$
<b>Transducer Gain</b>		–		–	dB	$Z_S = Z_L = 50\ \Omega$
Low Noise Operation Point	$S_{21}$		22.5			$I_C = 5\text{ mA}$
High Linearity Operation Point	$S_{21}$		27.5			$I_C = 13\text{ mA}$
<b>Minimum Noise Figure</b>		–		–	dB	$Z_S = Z_{opt}$
Minimum Noise Figure	$NF_{min}$		0.4			$I_C = 5\text{ mA}$
Associated Gain	$G_{ass}$		26			$I_C = 5\text{ mA}$
<b>Linearity</b>		–		–	dBm	$Z_S = Z_L = 50\ \Omega$
1 dB Gain Compression Point	$OP_{1dB}$		5.5			$I_C = 13\text{ mA}$
3 <sup>rd</sup> Order Intercept Point	$OIP_3$		21			$I_C = 13\text{ mA}$

Electrical Characteristics

**Table 10 AC Characteristics,  $V_{CE} = 3\text{ V}$ ,  $f = 1500\text{ MHz}$**

Parameter	Symbol	Values			Unit	Note / Test Condition
		Min.	Typ.	Max.		
<b>Maximum Power Gain</b>		–		–	dB	
Low Noise Operation Point	$G_{ms}$		24			$I_C = 5\text{ mA}$
High Linearity Operation Point	$G_{ms}$		27.5			$I_C = 13\text{ mA}$
<b>Transducer Gain</b>		–		–	dB	$Z_S = Z_L = 50\ \Omega$
Low Noise Operation Point	$S_{21}$		22			$I_C = 5\text{ mA}$
High Linearity Operation Point	$S_{21}$		25.5			$I_C = 13\text{ mA}$
<b>Minimum Noise Figure</b>		–		–	dB	$Z_S = Z_{opt}$
Minimum Noise Figure	$NF_{min}$		0.45			$I_C = 5\text{ mA}$
Associated Gain	$G_{ass}$		24			$I_C = 5\text{ mA}$
<b>Linearity</b>		–		–	dBm	$Z_S = Z_L = 50\ \Omega$
1 dB Gain Compression Point	$OP_{1dB}$		6			$I_C = 13\text{ mA}$
3 <sup>rd</sup> Order Intercept Point	$OIP_3$		21.5			$I_C = 13\text{ mA}$

**Table 11 AC Characteristics,  $V_{CE} = 3\text{ V}$ ,  $f = 1.9\text{ GHz}$**

Parameter	Symbol	Values			Unit	Note / Test Condition
		Min.	Typ.	Max.		
<b>Maximum Power Gain</b>		–		–	dB	
Low Noise Operation Point	$G_{ms}$		23			$I_C = 5\text{ mA}$
High Linearity Operation Point	$G_{ms}$		26			$I_C = 13\text{ mA}$
<b>Transducer Gain</b>		–		–	dB	$Z_S = Z_L = 50\ \Omega$
Low Noise Operation Point	$S_{21}$		21.5			$I_C = 5\text{ mA}$
High Linearity Operation Point	$S_{21}$		24.5			$I_C = 13\text{ mA}$
<b>Minimum Noise Figure</b>		–		–	dB	$Z_S = Z_{opt}$
Minimum Noise Figure	$NF_{min}$		0.45			$I_C = 5\text{ mA}$
Associated Gain	$G_{ass}$		23			$I_C = 5\text{ mA}$
<b>Linearity</b>		–		–	dBm	$Z_S = Z_L = 50\ \Omega$
1 dB Gain Compression Point	$OP_{1dB}$		7			$I_C = 13\text{ mA}$
3 <sup>rd</sup> Order Intercept Point	$OIP_3$		22			$I_C = 13\text{ mA}$



**Table 12 AC Characteristics,  $V_{CE} = 3\text{ V}$ ,  $f = 2.4\text{ GHz}$**

Parameter	Symbol	Values			Unit	Note / Test Condition
		Min.	Typ.	Max.		
<b>Maximum Power Gain</b>		–		–	dB	
Low Noise Operation Point	$G_{ms}$		22			$I_C = 5\text{ mA}$
High Linearity Operation Point	$G_{ms}$		25			$I_C = 13\text{ mA}$
<b>Transducer Gain</b>		–		–	dB	$Z_S = Z_L = 50\ \Omega$
Low Noise Operation Point	$S_{21}$		20.5			$I_C = 5\text{ mA}$
High Linearity Operation Point	$S_{21}$		23			$I_C = 13\text{ mA}$
<b>Minimum Noise Figure</b>		–		–	dB	$Z_S = Z_{opt}$
Minimum Noise Figure	$NF_{min}$		0.5			$I_C = 5\text{ mA}$
Associated Gain	$G_{ass}$		21.5			$I_C = 5\text{ mA}$
<b>Linearity</b>		–		–	dBm	$Z_S = Z_L = 50\ \Omega$
1 dB Gain Compression Point	$OP_{1dB}$		6			$I_C = 13\text{ mA}$
3 <sup>rd</sup> Order Intercept Point	$OIP_3$		22			$I_C = 13\text{ mA}$

**Table 13 AC Characteristics,  $V_{CE} = 3\text{ V}$ ,  $f = 3.5\text{ GHz}$**

Parameter	Symbol	Values			Unit	Note / Test Condition
		Min.	Typ.	Max.		
<b>Maximum Power Gain</b>		–		–	dB	
Low Noise Operation Point	$G_{ms}$		20.5			$I_C = 5\text{ mA}$
High Linearity Operation Point	$G_{ms}$		23.5			$I_C = 13\text{ mA}$
<b>Transducer Gain</b>		–		–	dB	$Z_S = Z_L = 50\ \Omega$
Low Noise Operation Point	$S_{21}$		18.5			$I_C = 5\text{ mA}$
High Linearity Operation Point	$S_{21}$		20			$I_C = 13\text{ mA}$
<b>Minimum Noise Figure</b>		–		–	dB	$Z_S = Z_{opt}$
Minimum Noise Figure	$NF_{min}$		0.55			$I_C = 5\text{ mA}$
Associated Gain	$G_{ass}$		19			$I_C = 5\text{ mA}$
<b>Linearity</b>		–		–	dBm	$Z_S = Z_L = 50\ \Omega$
1 dB Gain Compression Point	$OP_{1dB}$		7.5			$I_C = 13\text{ mA}$
3 <sup>rd</sup> Order Intercept Point	$OIP_3$		22.5			$I_C = 13\text{ mA}$

**Table 14 AC Characteristics,  $V_{CE} = 3\text{ V}$ ,  $f = 5.5\text{ GHz}$**

Parameter	Symbol	Values			Unit	Note / Test Condition
		Min.	Typ.	Max.		
<b>Maximum Power Gain</b>		–		–	dB	$I_C = 5\text{ mA}$ $I_C = 13\text{ mA}$
Low Noise Operation Point	$G_{ms}$		19			
High Linearity Operation Point	$G_{ma}$		19.5			
<b>Transducer Gain</b>		–		–	dB	$Z_S = Z_L = 50\ \Omega$ $I_C = 5\text{ mA}$ $I_C = 13\text{ mA}$
Low Noise Operation Point	$S_{21}$		15			
High Linearity Operation Point	$S_{21}$		16			
<b>Minimum Noise Figure</b>		–		–	dB	$Z_S = Z_{opt}$ $I_C = 5\text{ mA}$ $I_C = 5\text{ mA}$
Minimum Noise Figure	$NF_{min}$		0.7			
Associated Gain	$G_{ass}$		15			
<b>Linearity</b>		–		–	dBm	$Z_S = Z_L = 50\ \Omega$ $I_C = 13\text{ mA}$ $I_C = 13\text{ mA}$
1 dB Gain Compression Point	$OP_{1dB}$		8.5			
3 <sup>rd</sup> Order Intercept Point	$OIP_3$		23			

**Table 15 AC Characteristics,  $V_{CE} = 3\text{ V}$ ,  $f = 10\text{ GHz}$**

Parameter	Symbol	Values			Unit	Note / Test Condition
		Min.	Typ.	Max.		
<b>Maximum Power Gain</b>		–		–	dB	$I_C = 5\text{ mA}$ $I_C = 13\text{ mA}$
Low Noise Operation Point	$G_{ma}$		13.5			
High Linearity Operation Point	$G_{ma}$		15			
<b>Transducer Gain</b>		–		–	dB	$Z_S = Z_L = 50\ \Omega$ $I_C = 5\text{ mA}$ $I_C = 13\text{ mA}$
Low Noise Operation Point	$S_{21}$		9			
High Linearity Operation Point	$S_{21}$		10			
<b>Minimum Noise Figure</b>		–		–	dB	$Z_S = Z_{opt}$ $I_C = 5\text{ mA}$ $I_C = 5\text{ mA}$
Minimum Noise Figure	$NF_{min}$		0.95			
Associated Gain	$G_{ass}$		10.5			
<b>Linearity</b>		–		–	dBm	$Z_S = Z_L = 50\ \Omega$ $I_C = 13\text{ mA}$ $I_C = 13\text{ mA}$
1 dB Gain Compression Point	$OP_{1dB}$		8			
3 <sup>rd</sup> Order Intercept Point	$OIP_3$		19.5			

**Notes**

- $G_{ms} = |S_{21} / S_{12}|$  for  $k < 1$ ;  $G_{ma} = |S_{21} / S_{12}|(k - (k^2 - 1)^{1/2})$  for  $k > 1$
- In order to get the  $NF_{min}$  values stated in this chapter the test fixture losses have been subtracted from all measured results

5.4 Characteristic Curves

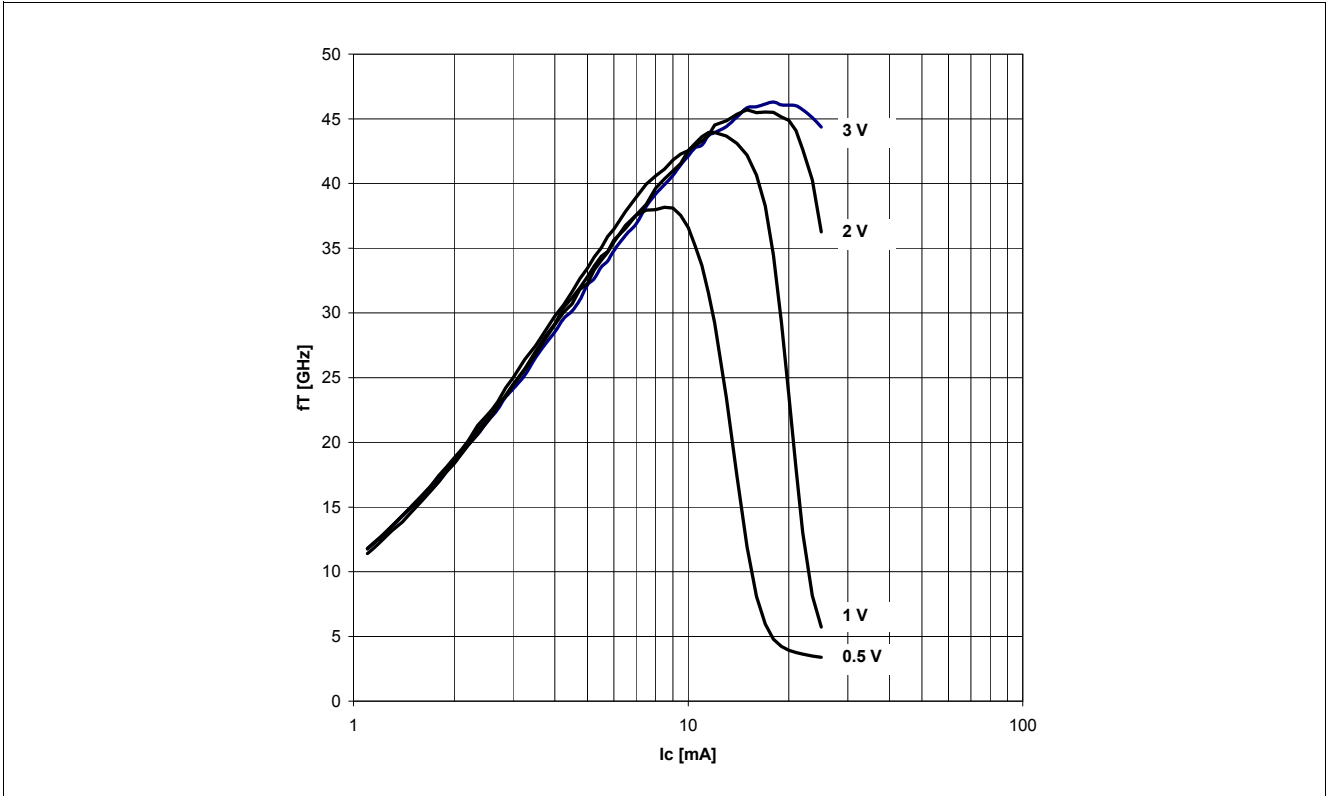

Figure 5 Transition Frequency  $f_T = f(I_C, V_{CE})$   $f = 1 \text{ GHz}$ ,  $V_{CE}$  Parameter in V

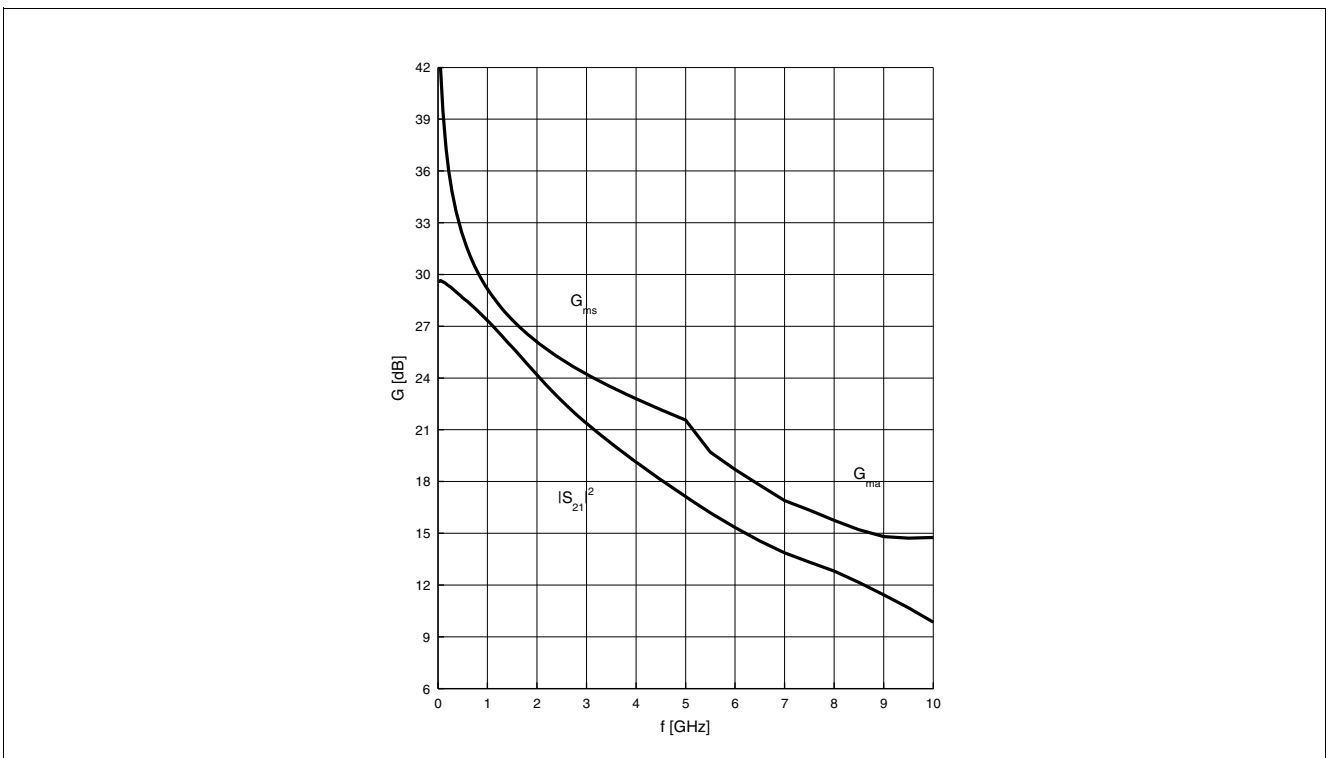

Figure 6 Power Gain  $G_{mat}$ ,  $G_{ms}$ ,  $IS_{21}^2 = f(f)$   $V_{CE} = 3 \text{ V}$ ,  $I_C = 13 \text{ mA}$

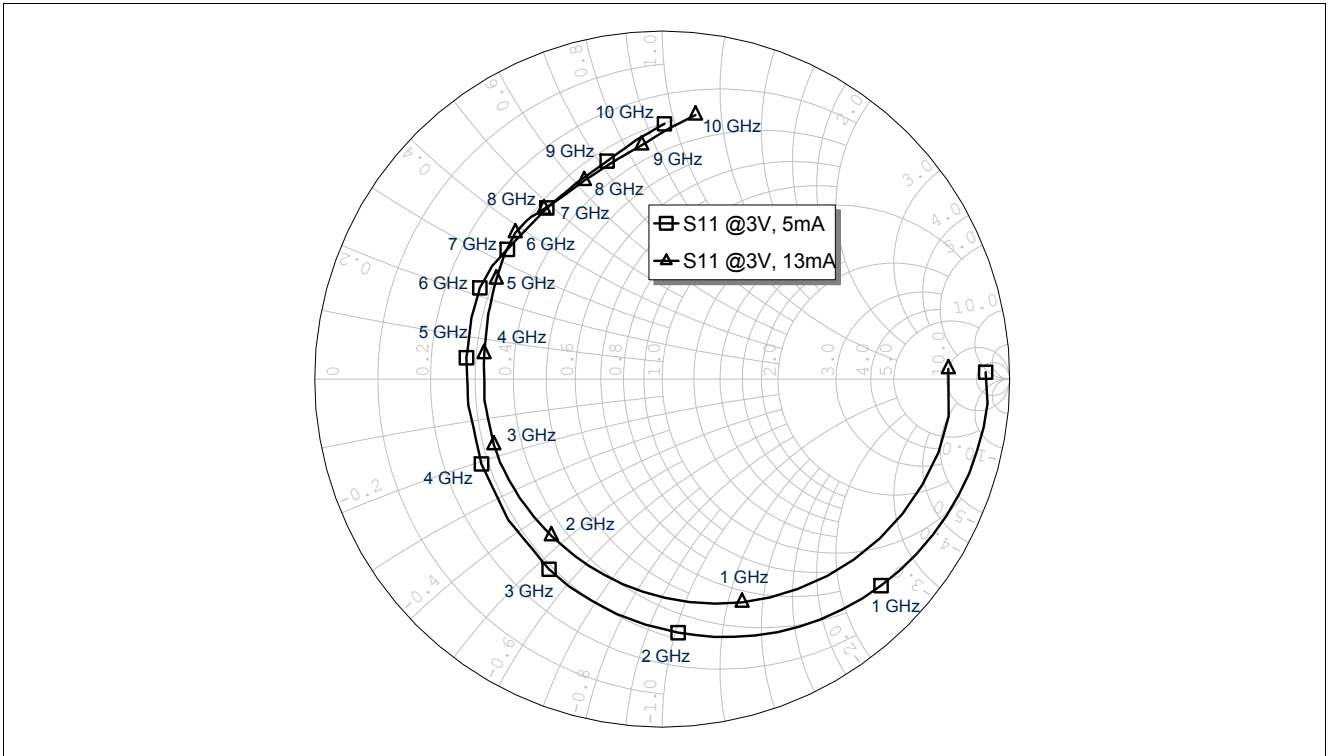

Figure 7 Input Matching  $S_{11}$  vs. Frequency  $V_{CE} = 3\text{ V}$ ,  $I_C = 5\text{ mA} / 13\text{ mA}$

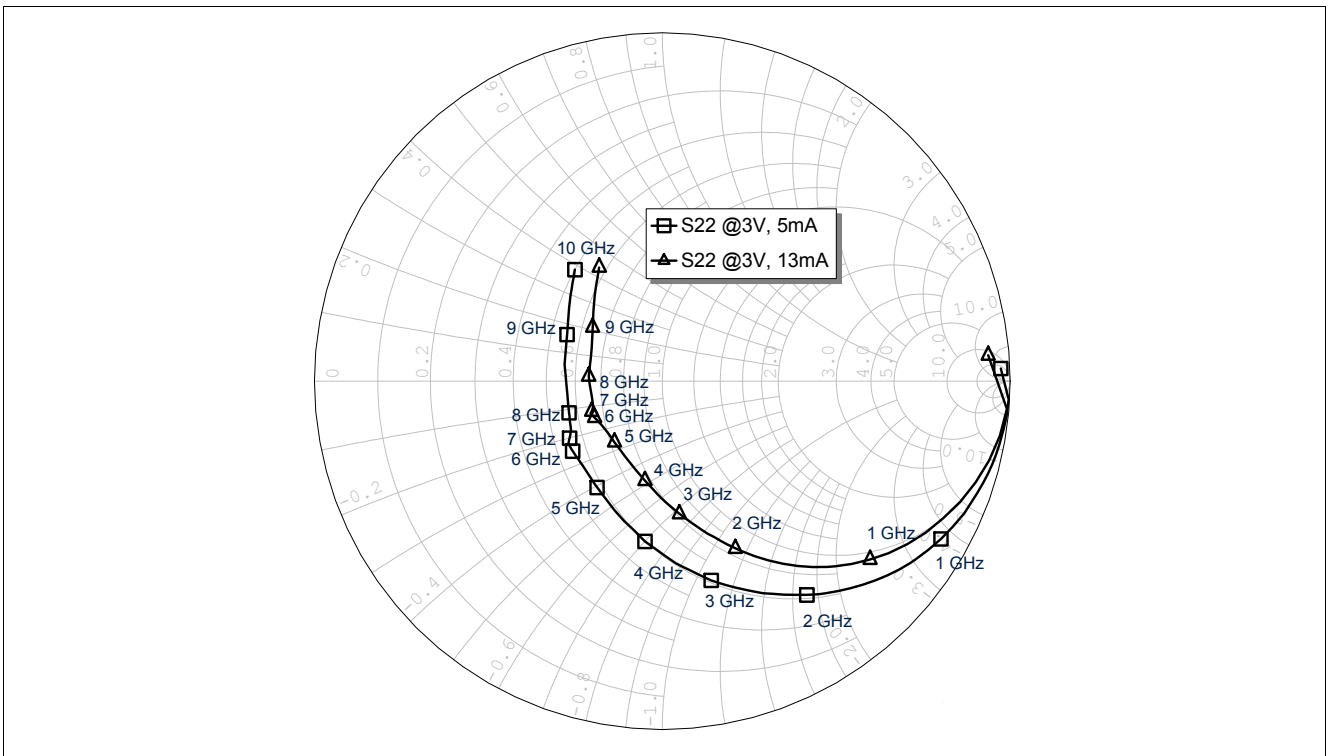

Figure 8 Output Matching  $S_{22}$  vs. Frequency  $V_{CE} = 3\text{ V}$ ,  $I_C = 5\text{ mA} / 13\text{ mA}$

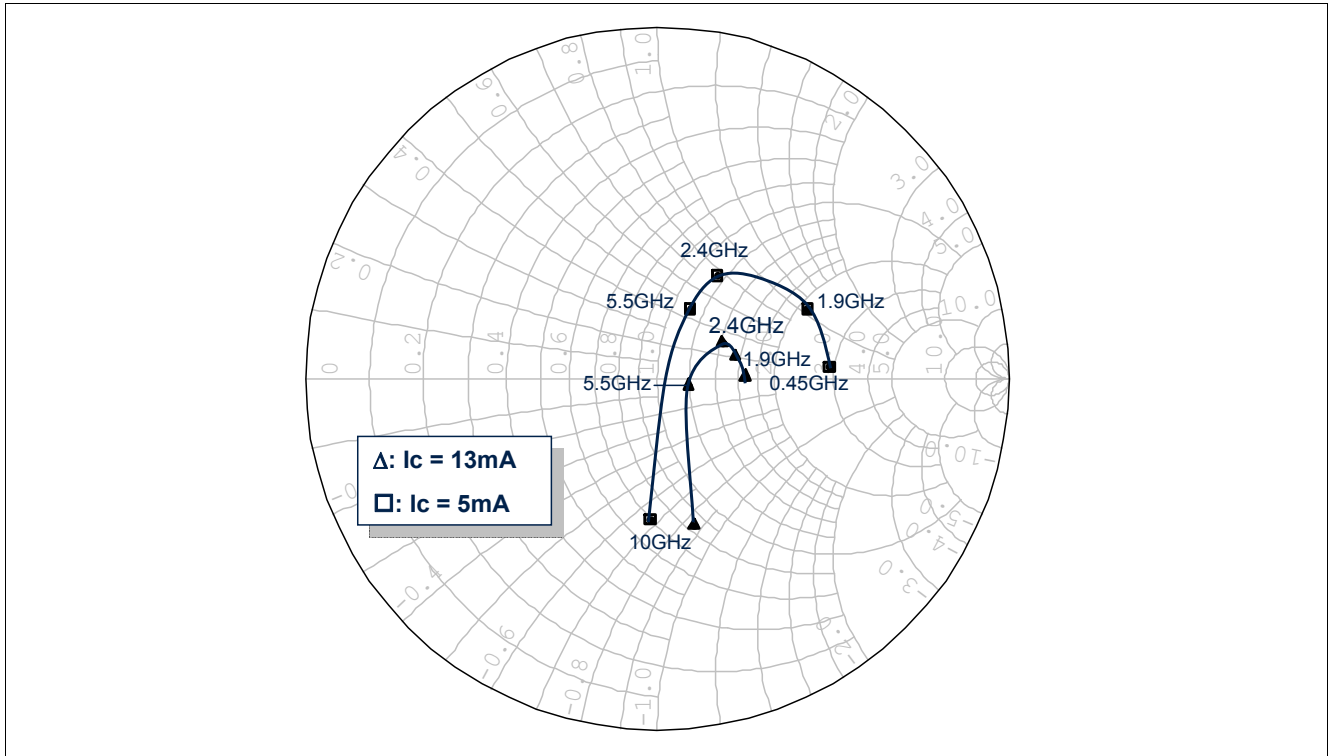

Figure 9 Source Impedance  $Z_{opt}$  for  $NF_{min}$  vs. Frequency  $V_{CE} = 3\text{ V}$ ,  $I_C = 5\text{ mA} / 13\text{ mA}$

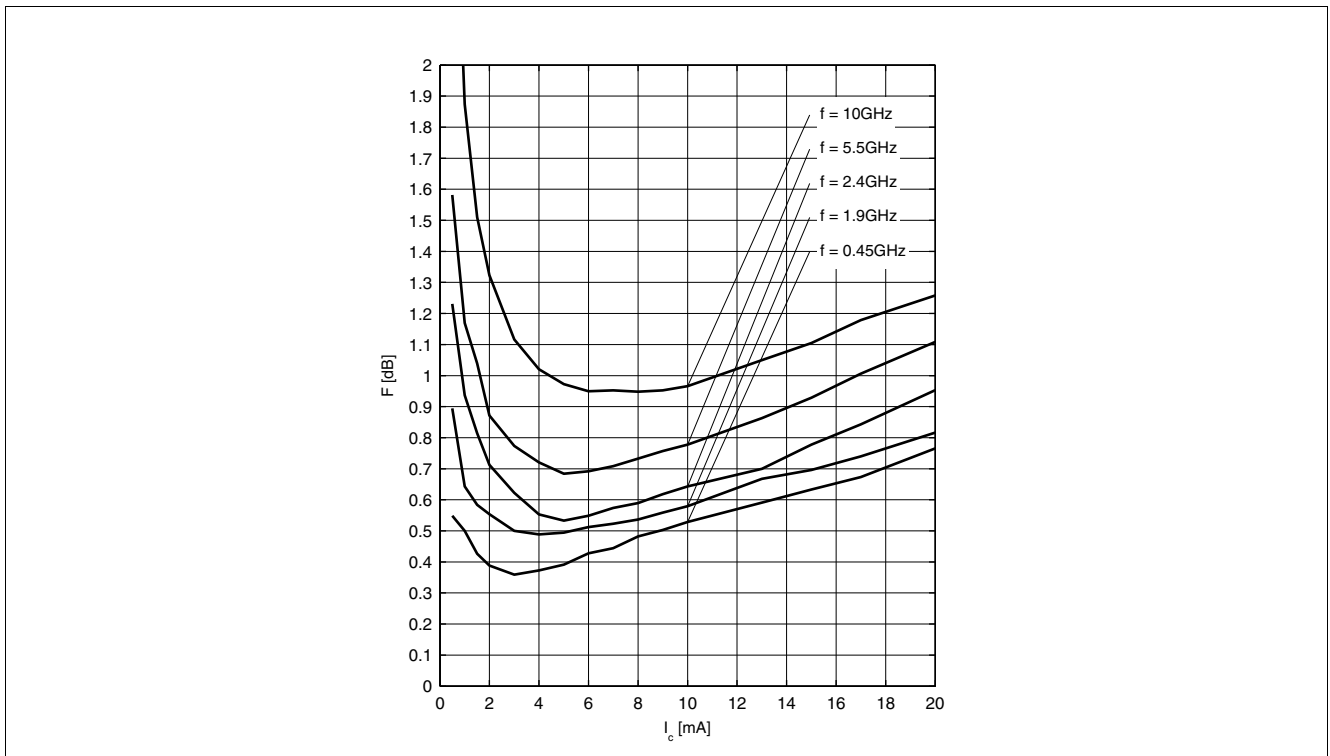

Figure 10 Noise Figure  $NF_{min} = f(I_C)$   $V_{CE} = 3\text{ V}$ ,  $Z_S = Z_{opt}$

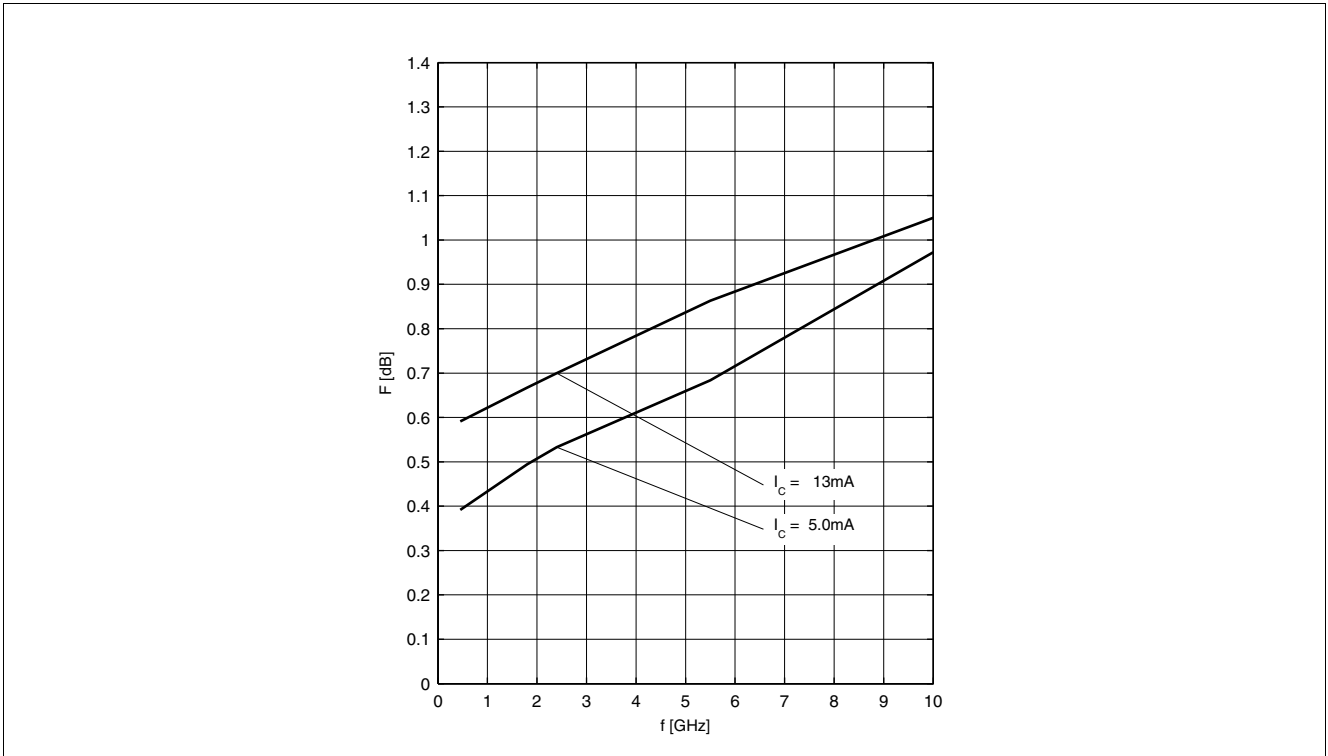

Figure 11 Noise Figure  $NF_{min} = f(f) V_{CE} = 3 V, Z_S = Z_{op}$

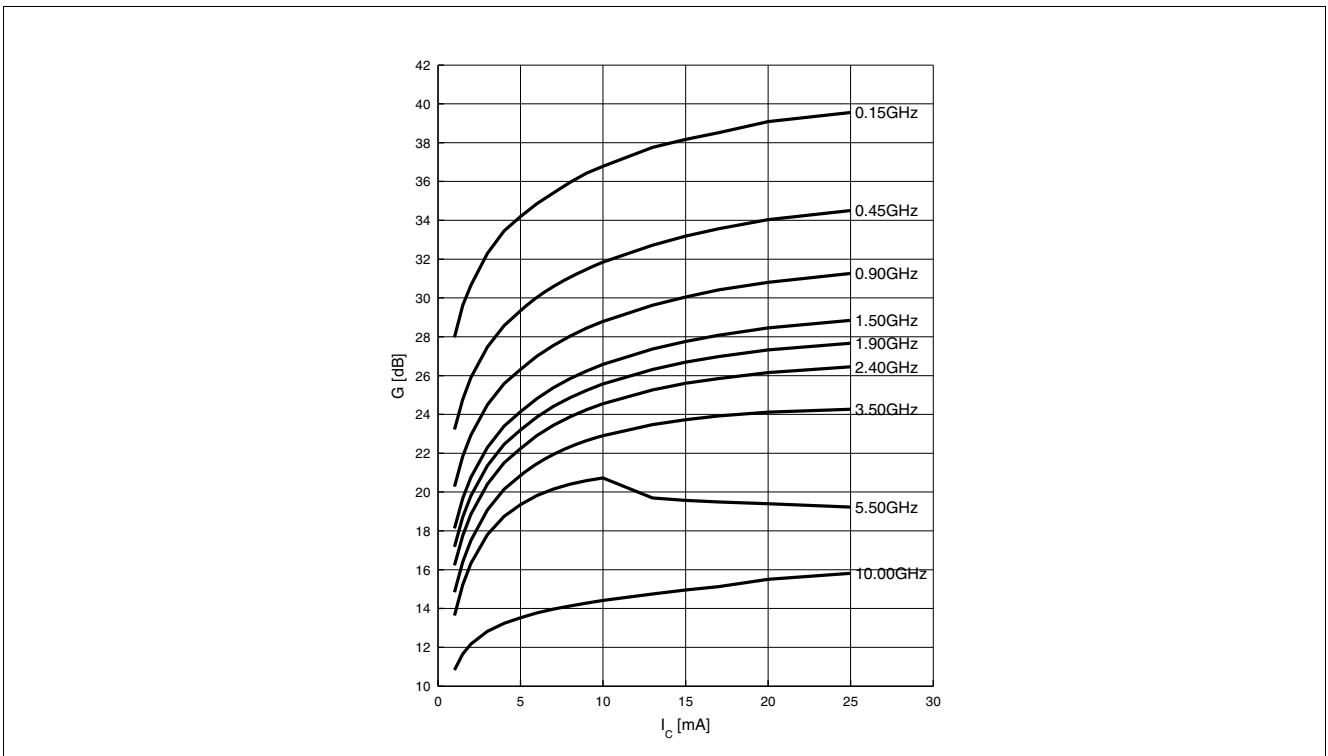
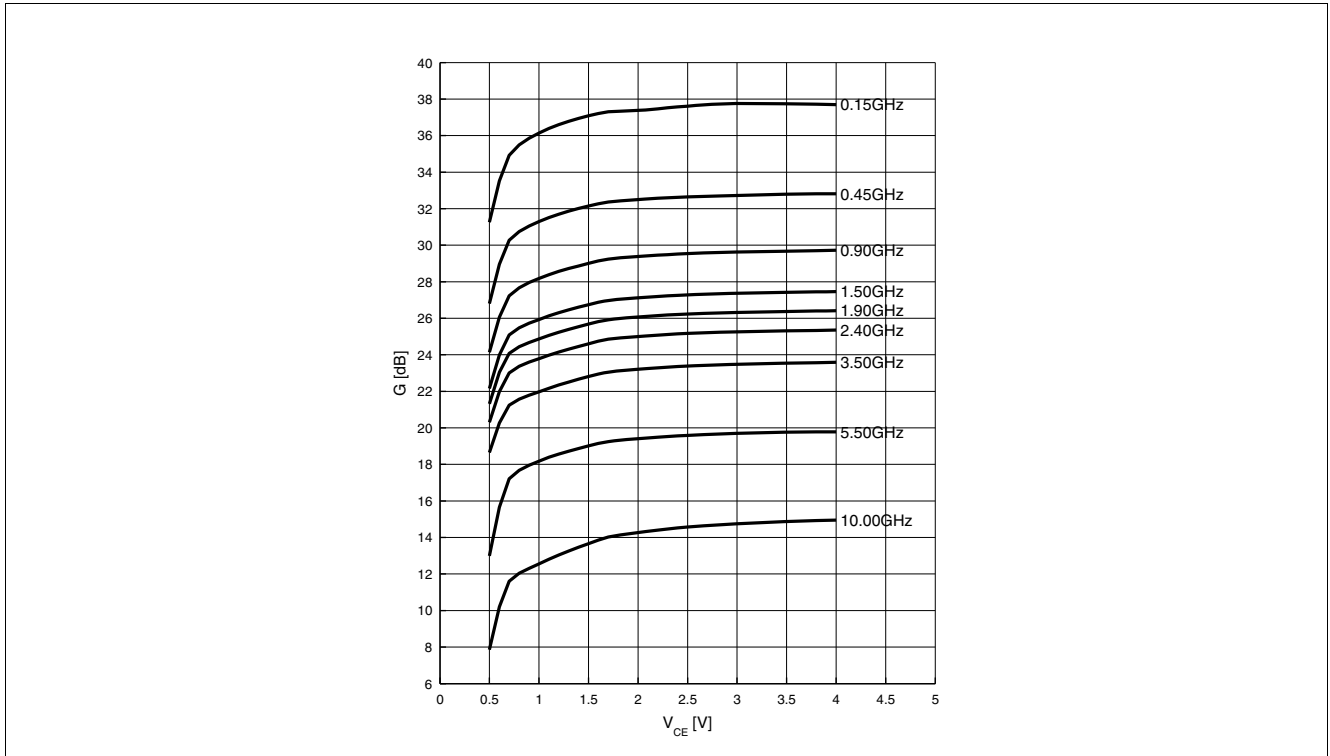

Figure 12 Power Gain  $G_{ma}, G_{ms} = f(I_c) V_{CE} = 3 V, f = \text{Parameter in GHz}$



**Figure 13 Power Gain  $G_{ma}$ ,  $G_{ms} = f(V_{CE}) I_C = 13 \text{ mA}$ ,  $f = \text{Parameter in GHz}$**

*Note: The curves shown in this chapter have been generated using typical devices but shall not be considered as a guarantee that all devices have identical characteristic curves.*

## 6 Simulation Data

For SPICE-model as well as for S-parameters including noise parameters please refer to our internet website: [www.infineon.com/rf.models](http://www.infineon.com/rf.models). Please consult our website and download the latest versions before actually starting your design.

The simulation data have been generated and verified using typical devices. The BFP720 nonlinear SPICE-model reflects the typical DC- and RF-device performance with high accuracy.



## 7 Package Information

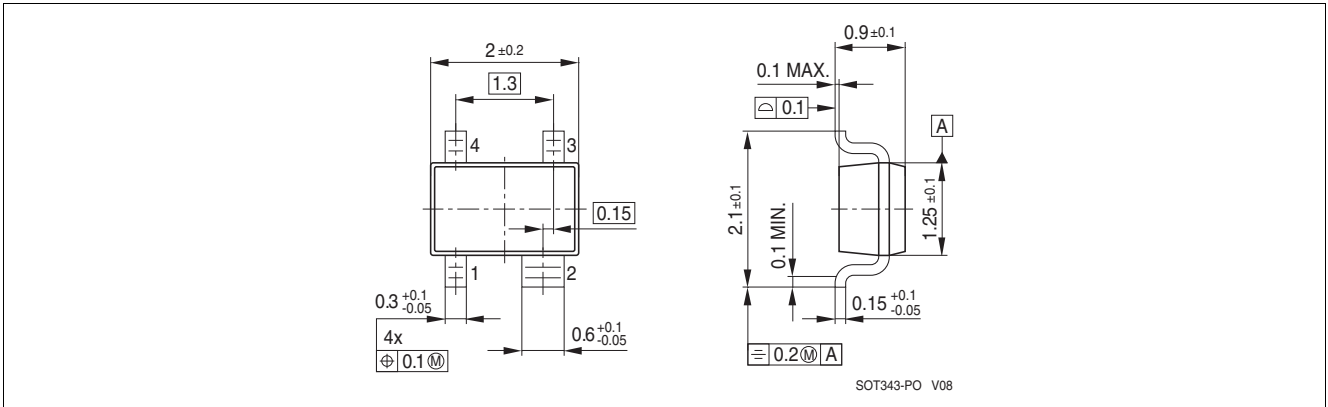

Figure 14 Package Outline SOT343 (top / side view)

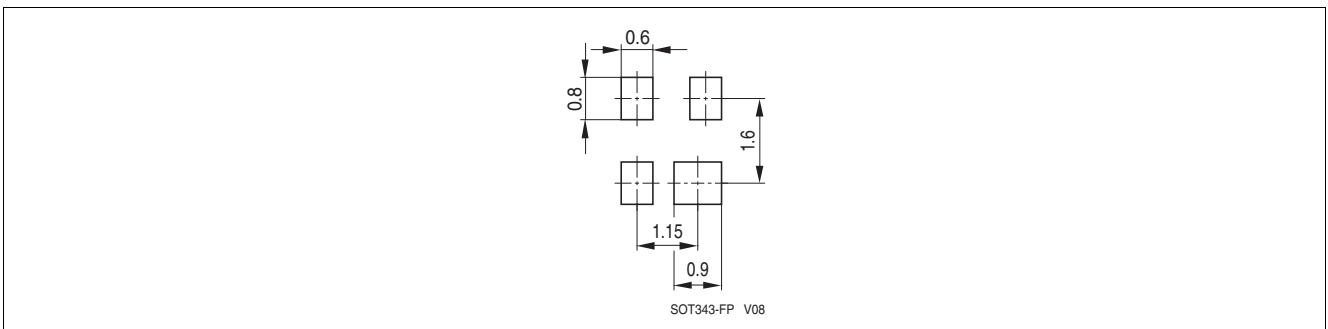

Figure 15 Footprint

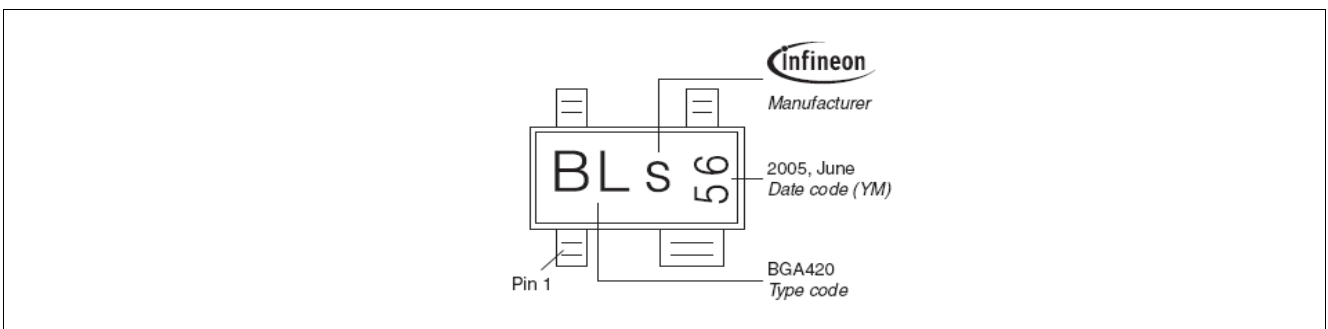

Figure 16 Marking Example (Marking BFP720: R9s)

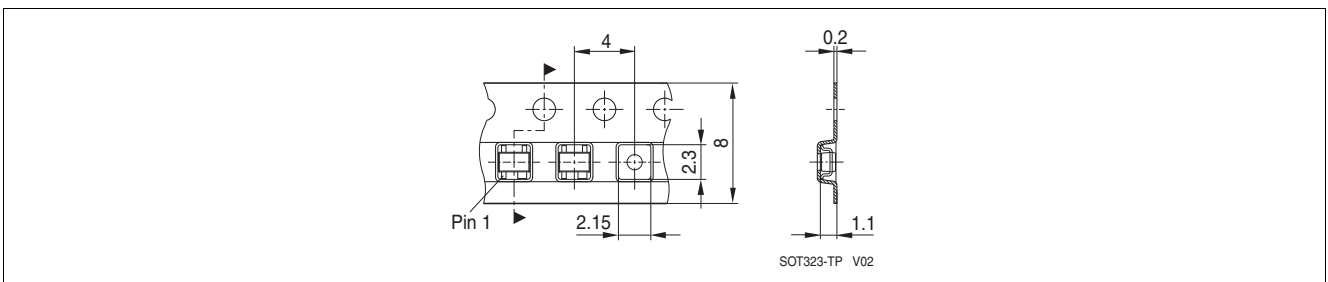

Figure 17 Tape Dimensions

[www.infineon.com](http://www.infineon.com)

Published by Infineon Technologies AG