

PLEASE CHECK WWW.MOLEX.COM FOR LATEST PART INFORMATION

Part Number: [0872642253](#)
Status: **Active**
Description: 2.00mm (.079") Pitch Milli-Grid™ Receptacle, Side Entry, Through Hole, 0.76µm (30µ") Gold (Au) Selective, 22 Circuits, Leadfree

Documents:

[3D Model](#) [Product Specification PS-87264 \(PDF\)](#)
[Drawing \(PDF\)](#) [RoHS Certificate of Compliance \(PDF\)](#)

Agency Certification

CSA LR19980
 UL E29179

General

Product Family PCB Receptacles
 Series [87264](#)
 Application Board-to-Board
 Product Literature Order No 987650-1991
 Product Name Milli-Grid™

Physical

Circuits (Loaded) 22
 Color - Resin Black
 Durability (mating cycles max) 25
 Flammability 94V-0
 Glow-Wire Compliant No
 Lock to Mating Part None
 Material - Metal Phosphor Bronze
 Material - Plating Mating Gold
 Material - Plating Termination Tin
 Material - Resin High Temperature Thermoplastic
 Number of Rows 2
 Orientation Right Angle
 PC Tail Length (in) 0.100 In
 PC Tail Length (mm) 2.55 mm
 PCB Locator No
 PCB Retention None
 PCB Thickness Recommended (in) 0.062 In
 PCB Thickness Recommended (mm) 1.60 mm
 Packaging Type Tube
 Pitch - Mating Interface (in) 0.079 In
 Pitch - Mating Interface (mm) 2.00 mm
 Plating min: Mating (µin) 30.4
 Plating min: Mating (µm) 0.76
 Plating min: Termination (µin) 101.6
 Plating min: Termination (µm) 2.54
 Polarized to PCB No
 Surface Mount Compatible (SMC) Yes
 Temperature Range - Operating -55°C to +105°C
 Termination Interface: Style Surface Mount

Electrical

Current - Maximum per Contact 1A
 Voltage - Maximum 125V

Solder Process Data

Lead-free Process Capability Wave Capable (TH only)

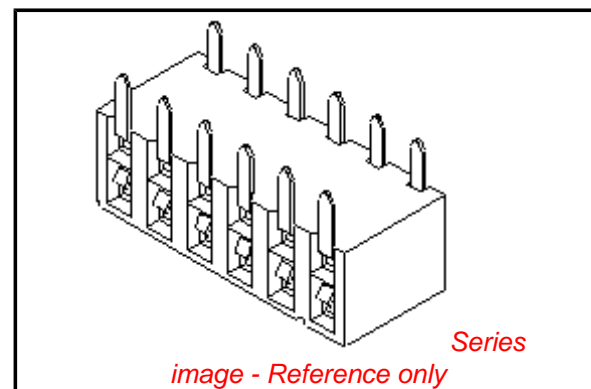

EU RoHS

ELV and RoHS Compliant
REACH SVHC Contains SVHC: No
Halogen-Free Status
Not Reviewed

China RoHS



Need more information on product environmental compliance?

Email productcompliance@molex.com
 For a multiple part number RoHS Certificate of Compliance, [click here](#)

Please visit the [Contact Us](#) section for any non-product compliance questions.

Search Parts in this Series

[87264Series](#)

Mates With

[87758](#) , [87759](#) , [87760](#)

Process Temperature max. C 260

Material Info

Reference - Drawing Numbers

Product Specification
Sales Drawing

PS-87264
SD-87264-**50

This document was generated on 03/18/2010

PLEASE CHECK WWW.MOLEX.COM FOR LATEST PART INFORMATION

10 9 8 7 6 5 4 3 2 1

F

E

D

C

B

A

F

E

D

C

B

A

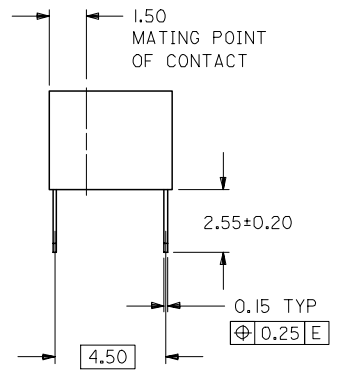
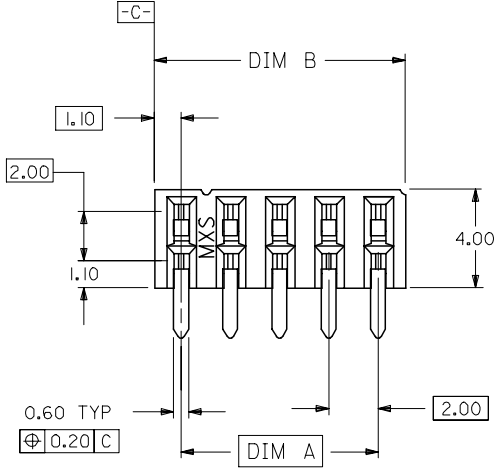

PART NO. LEGEND

87264- * * 5 *
 CIRCUIT SIZE PLATING
 POST-PLATED

- 2 - 0.38um/15uin MIN. GOLD PLATE IN SELECTED AREA AND 2.54um/100uin MIN. TIN IN SELECTED AREA OVER 1.27um/50uin NICKEL OVERALL (IN TUBE).
- 3 - 0.76um/30uin MIN. GOLD PLATE IN SELECTED AREA AND 2.54um/100uin MIN. TIN IN SELECTED AREA OVER 1.27um/50uin NICKEL OVERALL (IN TUBE).
- 8 - 0.38um/15uin MIN. GOLD PLATE IN SELECTED AREA AND 2.54um/100uin MIN. TIN IN SELECTED AREA OVER 1.27um/50uin NICKEL OVERALL. (IN TAPE/REEL)
- 9 - 0.76um/30uin MIN. GOLD PLATE IN SELECTED AREA AND 2.54um/100uin MIN. TIN IN SELECTED AREA OVER 1.27um/50uin NICKEL OVERALL. (IN TAPE/REEL)

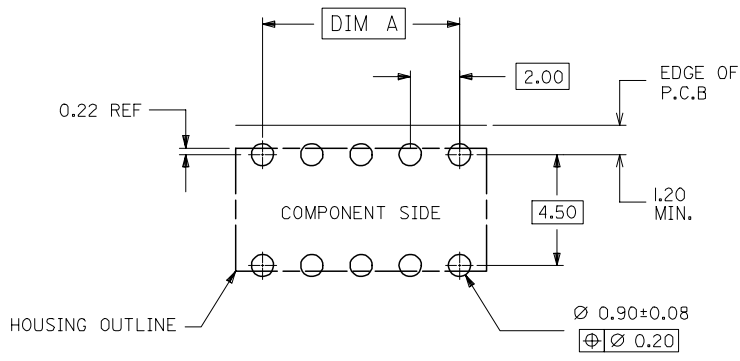
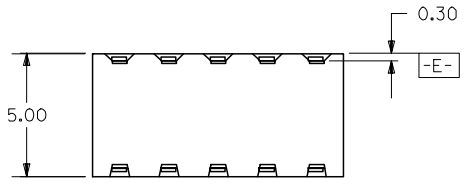

RECOMMENDED P.C. BOARD LAYOUT

- NOTES:
1. IO CIRCUIT SIZE SHOWN FOR ILLUSTRATION ONLY. SEE CHART FOR AVAILABLE PART SIZES.
 2. PLATING FINISH : TERMINAL - AS PER LEGEND
 3. RECOMMENDED PC BOARD THICKNESS IS 1.60 +/- 0.10mm.
 4. PRODUCT SPECIFICATION PS-87264 APPLIES.
 5. PART IS MATEABLE TO ALL MILLI-GRID HEADERS WITH MATING PIN LENGTH BETWEEN 2.50mm AND 4.20mm.
 6. TAPE & REEL OPTION IS SHOWN ON SHT 3 WITH 8 CKT ILLUSTRATION.
 7. PARTS SHALL BE PACKED IN MOISTURE BARRIER BAG.

ADD NOTE 7. EC NO: S2008-0422 DRWN:SKANG CHKD:ATSEE APPR:MLONG	2007/11/20 2007/11/20 2007/11/22	DESCRIPTION REV	QUALITY SYMBOLS	GENERAL TOLERANCES (UNLESS SPECIFIED)	DIMENSION STYLE	SCALE	DESIGN UNITS	THIRD ANGLE PROJECTION	
			▽=0 ▽=0	mm INCH 4 PLACES ± --- ± --- 3 PLACES ± --- ± --- 2 PLACES ± 0.2 ± --- 1 PLACE ± --- ± --- ANGULAR ± 3 °	MM ONLY	NTS	METRIC	DRAWN BY DATE JWAN 1992/02/25 CHECKED BY DATE MLA1 1992/02/25 APPROVED BY DATE RWONG 1992/02/25	TITLE MGRID, 2MM DUAL ROW HDR. SIDE ENTRY RECEPTACLE T/H
			DRAFT WHERE APPLICABLE MUST REMAIN WITHIN DIMENSIONS	SEE TABLE	MATERIAL NO. SD-87264-***50	DOCUMENT NO. SD-87264-***50	SHEET NO. 1 OF 3		
			THIS DRAWING CONTAINS INFORMATION THAT IS PROPRIETARY TO MOLEX INCORPORATED AND SHOULD NOT BE USED WITHOUT WRITTEN PERMISSION						

9 8 7 6 5 4 3 2 1

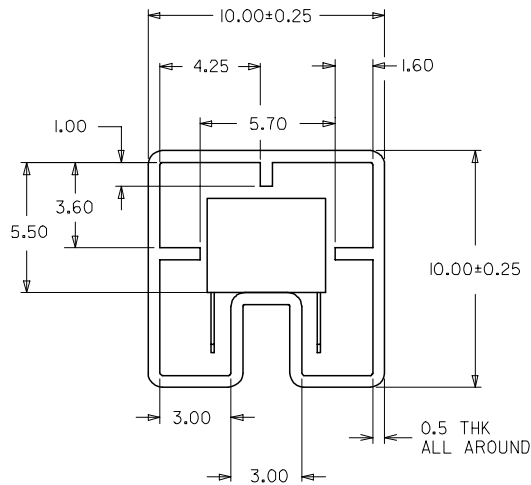
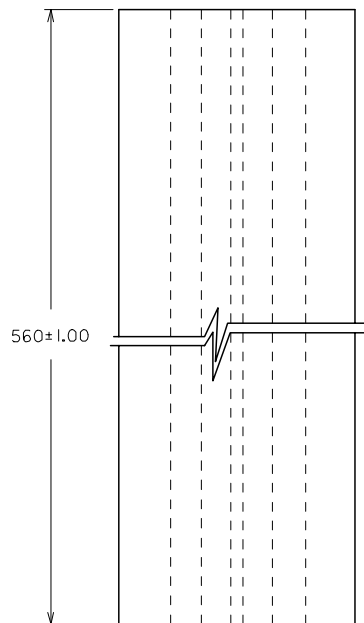

PART IN TUBE ORIENTATION.

PART NUMBER 0.38um GOLD PLATING \triangle_2	PART NUMBER 0.76um GOLD PLATING \triangle_2	CKT. SIZE	DIM A	DIM B
87264-065*	87264-065*	6	4.00	6.20
87264-085*	87264-085*	8	6.00	8.20
87264-105*	87264-105*	10	8.00	10.20
87264-125*	87264-125*	12	10.00	12.20
87264-145*	87264-145*	14	12.00	14.20
87264-165*	87264-165*	16	14.00	16.20
87264-185*	87264-185*	18	16.00	18.20
87264-205*	87264-205*	20	18.00	20.20
87264-225*	87264-225*	22	20.00	22.20
87264-245*	87264-245*	24	22.00	24.20
87264-265*	87264-265*	26	24.00	26.20
87264-285*	87264-285*	28	26.00	28.20
87264-305*	87264-305*	30	28.00	30.20
87264-325*	87264-325*	32	30.00	32.20
87264-345*	87264-345*	34	32.00	34.20
87264-365*	87264-365*	36	34.00	36.20
87264-385*	87264-385*	38	36.00	38.20
87264-405*	87264-405*	40	38.00	40.20
87264-425*	87264-425*	42	40.00	42.20
87264-445*	87264-445*	44	42.00	44.20
87264-465*	87264-465*	46	44.00	46.20
87264-485*	87264-485*	48	46.00	48.20
87264-505*	87264-505*	50	48.00	50.20

ADD NOTE 7. EC NO: S2008-0422 DRWNS:KANG 2007/11/20 CHKD:ATSEE 2007/11/20 APPR:MLONG 2007/11/22	QUALITY SYMBOLS	GENERAL TOLERANCES (UNLESS SPECIFIED)	DIMENSION STYLE	SCALE	DESIGN UNITS	THIRD ANGLE PROJECTION																		
	$\nabla=0$ $\triangle=0$	<table border="1"> <thead> <tr> <th></th> <th>mm</th> <th>INCH</th> </tr> </thead> <tbody> <tr><td>4 PLACES</td><td>± ---</td><td>± ---</td></tr> <tr><td>3 PLACES</td><td>± ---</td><td>± ---</td></tr> <tr><td>2 PLACES</td><td>± 0.2</td><td>± ---</td></tr> <tr><td>1 PLACE</td><td>± ---</td><td>± ---</td></tr> </tbody> </table>		mm	INCH	4 PLACES	± ---	± ---	3 PLACES	± ---	± ---	2 PLACES	± 0.2	± ---	1 PLACE	± ---	± ---	MM ONLY	NTS	METRIC				
		mm	INCH																					
	4 PLACES	± ---	± ---																					
3 PLACES	± ---	± ---																						
2 PLACES	± 0.2	± ---																						
1 PLACE	± ---	± ---																						
<table border="1"> <tr><td>DRAWN BY</td><td>DATE</td><td>TITLE</td></tr> <tr><td>JWAN</td><td>1992/02/25</td><td rowspan="2">MGRID, 2MM DUAL ROW HDR. SIDE ENTRY RECEPTACLE T/H</td></tr> <tr><td>CHECKED BY</td><td>DATE</td></tr> <tr><td>MLA1</td><td>1992/02/25</td><td></td></tr> <tr><td>APPROVED BY</td><td>DATE</td><td></td></tr> <tr><td>RWONG</td><td>1992/02/25</td><td></td></tr> </table>	DRAWN BY	DATE	TITLE	JWAN	1992/02/25	MGRID, 2MM DUAL ROW HDR. SIDE ENTRY RECEPTACLE T/H	CHECKED BY	DATE	MLA1	1992/02/25		APPROVED BY	DATE		RWONG	1992/02/25		<table border="1"> <tr><td>MATERIAL NO.</td><td>DOCUMENT NO.</td><td>SHEET NO.</td></tr> <tr><td></td><td>SD-87264-***50</td><td>2 OF 3</td></tr> </table>	MATERIAL NO.	DOCUMENT NO.	SHEET NO.		SD-87264-***50	2 OF 3
DRAWN BY	DATE	TITLE																						
JWAN	1992/02/25	MGRID, 2MM DUAL ROW HDR. SIDE ENTRY RECEPTACLE T/H																						
CHECKED BY	DATE																							
MLA1	1992/02/25																							
APPROVED BY	DATE																							
RWONG	1992/02/25																							
MATERIAL NO.	DOCUMENT NO.	SHEET NO.																						
	SD-87264-***50	2 OF 3																						
<table border="1"> <tr><td>SIZE</td><td>THIS DRAWING CONTAINS INFORMATION THAT IS PROPRIETARY TO MOLEX INCORPORATED AND SHOULD NOT BE USED WITHOUT WRITTEN PERMISSION</td></tr> <tr><td>A3</td><td></td></tr> </table>	SIZE	THIS DRAWING CONTAINS INFORMATION THAT IS PROPRIETARY TO MOLEX INCORPORATED AND SHOULD NOT BE USED WITHOUT WRITTEN PERMISSION	A3		DRAFT WHERE APPLICABLE MUST REMAIN WITHIN DIMENSIONS																			
SIZE	THIS DRAWING CONTAINS INFORMATION THAT IS PROPRIETARY TO MOLEX INCORPORATED AND SHOULD NOT BE USED WITHOUT WRITTEN PERMISSION																							
A3																								

PART NUMBER 0.38um GOLD PLATING \triangle_2 (IN TAPE/REEL)	PART NUMBER 0.76um GOLD PLATING \triangle_2 (IN TAPE/REEL)	CKT SIZE	DIM W	DIM F	DIM Bo
87264-085*	87264-085*	8	24.00	11.50	8.80

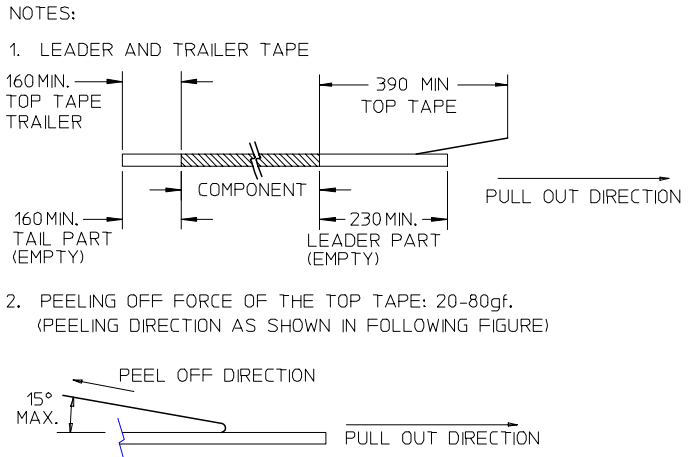
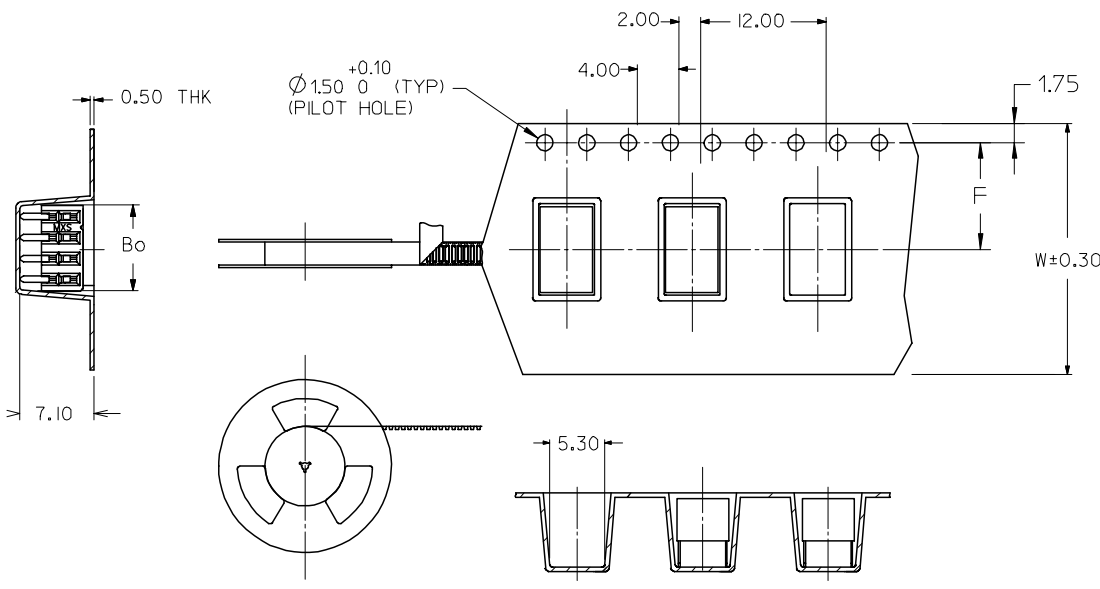

- PACKAGING STANDARD IS AS PER EIA-481.
- TAPE & REEL QUANTITY = 600PCS/REEL

CUSTOMER PULL OUT DIRECTION →

ADD NOTE 7. EC NO: S2008-0422 DRWNS:KANG 2007/11/20 CHKD:ATSEE 2007/11/20 APPR:MLONG 2007/11/22	QUALITY SYMBOLS	GENERAL TOLERANCES (UNLESS SPECIFIED)	DIMENSION STYLE	SCALE	DESIGN UNITS	THIRD ANGLE PROJECTION																		
	$\nabla=0$ $\triangle=0$	<table border="1"> <tr> <th></th> <th>mm</th> <th>INCH</th> </tr> <tr> <td>4 PLACES</td> <td>± ---</td> <td>± ---</td> </tr> <tr> <td>3 PLACES</td> <td>± ---</td> <td>± ---</td> </tr> <tr> <td>2 PLACES</td> <td>± 0.2</td> <td>± ---</td> </tr> <tr> <td>1 PLACE</td> <td>± ---</td> <td>± ---</td> </tr> <tr> <td colspan="3">ANGULAR ± 3°</td> </tr> </table>		mm	INCH	4 PLACES	± ---	± ---	3 PLACES	± ---	± ---	2 PLACES	± 0.2	± ---	1 PLACE	± ---	± ---	ANGULAR ± 3°			MM ONLY	NTS	METRIC	
		mm	INCH																					
	4 PLACES	± ---	± ---																					
3 PLACES	± ---	± ---																						
2 PLACES	± 0.2	± ---																						
1 PLACE	± ---	± ---																						
ANGULAR ± 3°																								
DESCRIPTION	DRAWN BY	DATE	TITLE	MGRID, 2MM DUAL ROW HDR. SIDE ENTRY RECEPTACLE T/H MOLEX INCORPORATED																				
REV	JWAN	1992/02/25																						
	1	MLA1	1992/02/25	<table border="1"> <tr> <td>MATERIAL NO.</td> <td>DOCUMENT NO.</td> <td>SHEET NO.</td> </tr> <tr> <td></td> <td>SD-87264-**-50</td> <td>3 OF 3</td> </tr> </table>	MATERIAL NO.	DOCUMENT NO.	SHEET NO.		SD-87264-**-50	3 OF 3														
MATERIAL NO.	DOCUMENT NO.	SHEET NO.																						
	SD-87264-**-50	3 OF 3																						
		RWONG	1992/02/25	<table border="1"> <tr> <td>SIZE</td> <td colspan="2">THIS DRAWING CONTAINS INFORMATION THAT IS PROPRIETARY TO MOLEX INCORPORATED AND SHOULD NOT BE USED WITHOUT WRITTEN PERMISSION</td> </tr> <tr> <td>A3</td> <td colspan="2"></td> </tr> </table>	SIZE	THIS DRAWING CONTAINS INFORMATION THAT IS PROPRIETARY TO MOLEX INCORPORATED AND SHOULD NOT BE USED WITHOUT WRITTEN PERMISSION		A3																
SIZE	THIS DRAWING CONTAINS INFORMATION THAT IS PROPRIETARY TO MOLEX INCORPORATED AND SHOULD NOT BE USED WITHOUT WRITTEN PERMISSION																							
A3																								