

ADSL MAGNETICS

- SUITABLE FOR FOR USE IN THE ADSL INTERFACE AT THE CUSTOMER PREMISES
- 6Mbps/640ADSL AND RADSL APPLICATIONS
- C.O. LINE INTERFACE APPLICATIONS
- IEC950 DESIGNS AVAILABLE
- SURFACE MOUNT MODELS ARE AVAILABLE - CONSULT FACTORY

PART NUMBER	XFADSL1	XFADSL2	XFADSL3	XFADSL4	XFADSL5	XFADSL6	XFADSL7	XFADSL8
URNS RATIO:	1:1:1:1	1.41:1.41:1:1	1:1:1:1	1:1:1:1	1.41:1.41:1:1	1:1:1:1	1:1:1:1	1:1:1.41:1.41
PRI. INDUCTANCE:	408uH	948uH	25.5mH	25.5mH	948uH	408uH	408uH	477uH
LEAKAGE IND.:	12uh	12uH	5.0uH	10.0uH	12uH	12uH	10uH	10uH
DCR-PRI.:	1.0	1.0	1.5	1.5	1.0	1.0	1.32	1.40
SEC:	1.0	1.0	1.0	1.0	1.0	1.0	1.12	2.18
Cw/w:	25pF	60pF	15pF	10pF	45pF	35pF	30pF	20pF
INSERTION LOSS:	3db	3db	1db	1db	3db	3db	1db	1db
LONGITUDINAL BALANCE:	53db	53db	53db	53db	53db	53db	55db	55db
APPLICATION/SAFTY AGENCY:	C.P.	C.O.	C.P.	C.P.	C.O./IEC950	C.P./IEC950	C.P./IEC950	C.O./IEC950
ISOLATION:	2500	2500	2500	2500	3000	3000	2000	2000

NOTES;

FOR ALL UNITS;

1. PRI. INDUCTANCE IS +/-5% ACROSS ENTIRE PRIMARY. MEASURED AT 10kHz, 0.10v, 100ma. DC EXCEPT XFADSL3 AND 4. XFADSL3 AND 4 ARE MINIMUM WITH NO DC.
2. LEAKAGE INDUCTANCE IS MAXIMUM. MEASURED ACROSS ENTIRE PRIMARY WITH ALL SECONDARIES SHORTED. MEASURED AT 100kHz, 0.10v.
3. Cw/w IS MAXIMUM. MEASURED BETWEEN HALF PRIMARY AND HALF SECONDARY. MEASURED AT 100kHz, 0.10v.
4. DCR IS MAXIMUM VALUE IN OHMS FOR EACH WINDING.
5. INSERTION LOSS IS MAXIMUM OVER 30kHz to 2 MHz.
6. LONGITUDINAL BALANCE IS MINIMUM OVER 20kHz to 250kHz.

INDIVIDUAL PART NUMBERS

1. XFADSL1 IS INTENDED FOR ADSL INTERFACE AT CUSTOMER PREMISES AND IS SUITABLE FOR BOTH 6Mbps/640 ADSL AND RADSL APPLICATIONS.
2. XFADSL2 IS INTENDED FOR C.O. LINE INTERFACE APPLICATION.
3. XFADSL3 AND XFADSL4 ARE INTENDED FOR C.P. APPLICATION WITH NO DC CURRENT
4. XFADSL5 AND XFADSL6 ARE FOR C.O. AND C.P. APPLICATIONS REQUIRING IEC950
5. XFADSL7 AND XFADSL8 ARE FOR C.O. AND C.P. APPLICATIONS REQUIRING IEC950 SUPPLEMENTORY INSULATION.

DIMENSIONS:

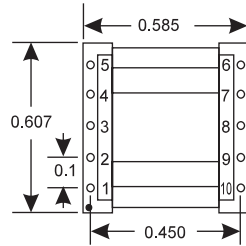
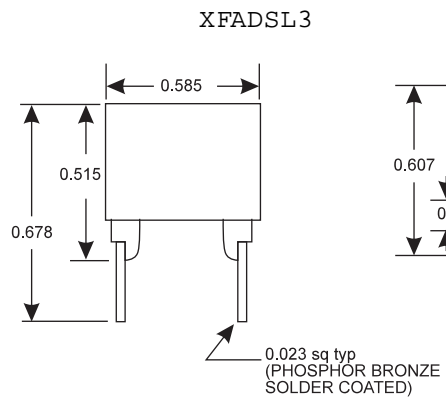

XFADSL4

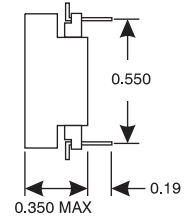
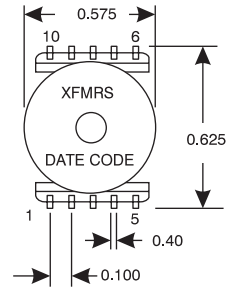

XFADSL7, XFADSL8

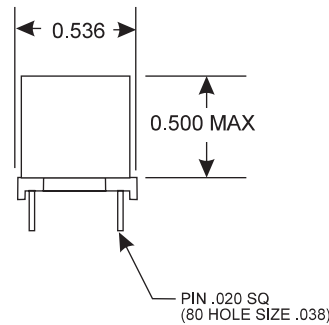
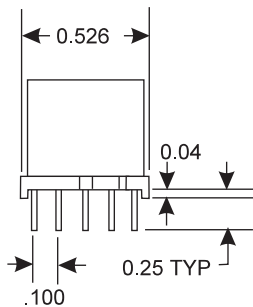

XFADSL1, XFADSL2, XFADSL5, XFADSL6

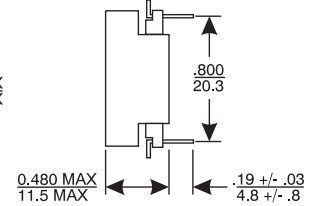
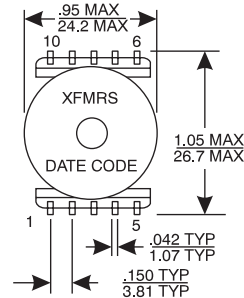

SCHEMATICS:

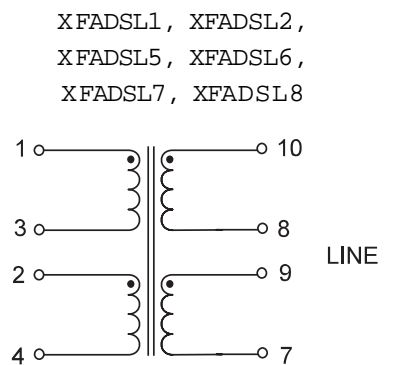
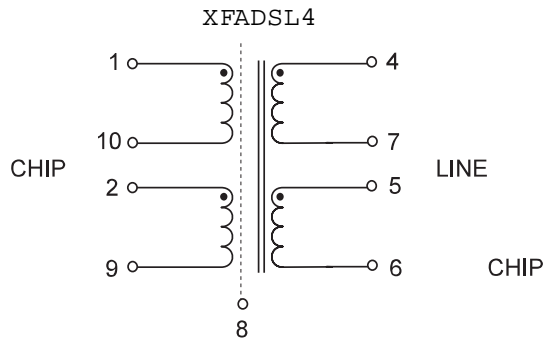
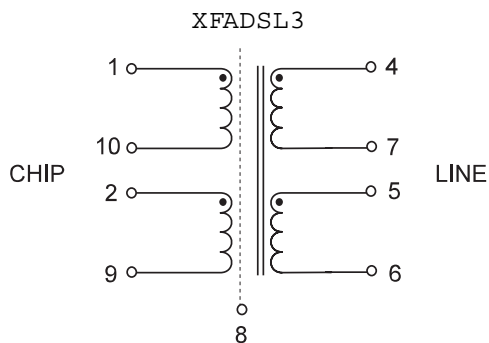

ADSL MAGNETICS**INDUCTORS AND COMMON MODE CHOKES FOR USE IN POTS SPLITTERS**

- INDUCTANCE REMAINS STABLE WITH DC POWERING CURRENTS UP TO 100ma
- PACKAGE OPTIONS AVAILABLE
- CUSTOM VALUES AVAILABLE AT NO EXTRA CHARGE
- ADSL LINE TRANSFORMERS AVAILABLE
- SMD PACKAGES AVAILABLE

ELETRICAL SPECIFICATIONS: @ 25°C:

PART NUMBER	INDUCTANCE EACH WINDING (mH \pm 5%)	DCR EACH WINDING (OHMS)	ISOLATION	PACKAGE STYLE
XF0043-AD1	4.0	2.0	1500	1
XF0043-AD2	4.0	2.0	1500	2
XF0063-AD1	6.0	4.0	1500	1
XF0063-AD2	6.0	4.0	1500	2
XF0073-AD1	7.0	5.5	1500	1
XF0073-AD2	7.0	5.5	1500	2
XF0093-AD1	8.5	5.0	1500	1
XF0093-AD2	8.5	5.0	1500	2
XF0103-AD1	10.0	5.5	1500	1
XF0103-AD2	10.0	5.5	1500	2
XF0093-AD3	9.0 \pm 30%	0.60	500	3

SCHEMATICS & DIMENSIONS:

OPTION #1

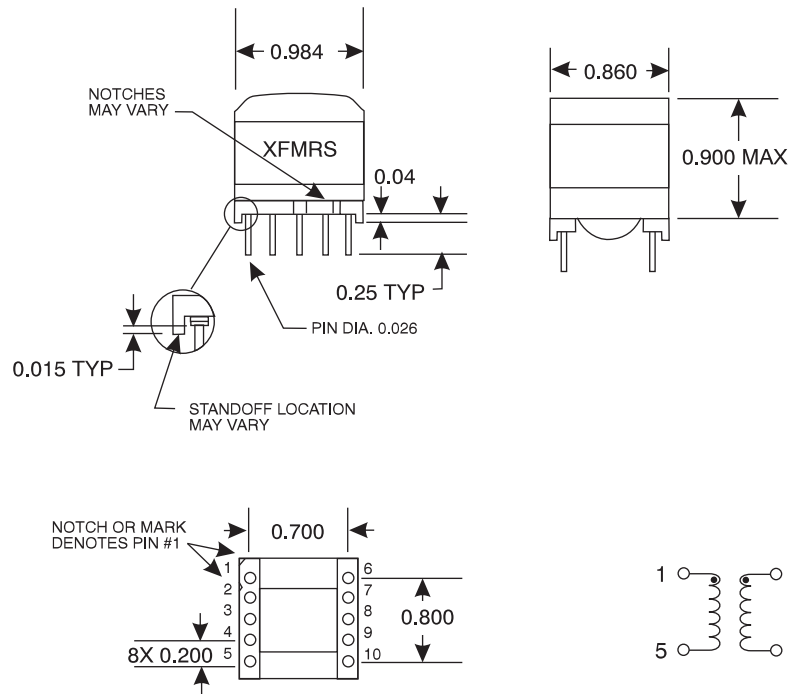

OPTION #2

XF0093-AD3 ONLY

