

PLEASE CHECK WWW.MOLEX.COM FOR LATEST PART INFORMATION

Part Number: [5017845009](#)
Status: **Active**
Description: 0.50mm (.020") Pitch FFC-to-Board Connector, Plug Jacket Cover, 50 Circuits

Documents:

Drawing (PDF)	Product Specification PS-501864-001 (PDF)
Product Specification PS-501786-001 (PDF)	Product Specification PS-501864-002 (PDF)
Product Specification PS-501786-002 (PDF)	RoHS Certificate of Compliance (PDF)

General

Product Family	Accessories
Series	501784
Component Type	Jacket Cover
Product Name	N/A

Physical

Breakaway	No
Circuits (Loaded)	N/A
Circuits (maximum)	50
Color - Resin	Black
Gender	Plug
Material - Resin	Polyester
Packaging Type	Bag
Polarized to Mating Part	Yes
Temperature Range - Operating	-40°C to +85°C

Electrical

Current - Maximum per Contact	0.5A
-------------------------------	------

Material Info

Reference - Drawing Numbers

Packaging Specification	SPK-501784-001
Product Specification	PS-501786-001, PS-501786-002, PS-501864-001, PS-501864-002, RPS-501786-001, RPS-501786-003, RPS-501786-006, RPS-501864-001, RPS-501864-006
Sales Drawing	SD-501784-001

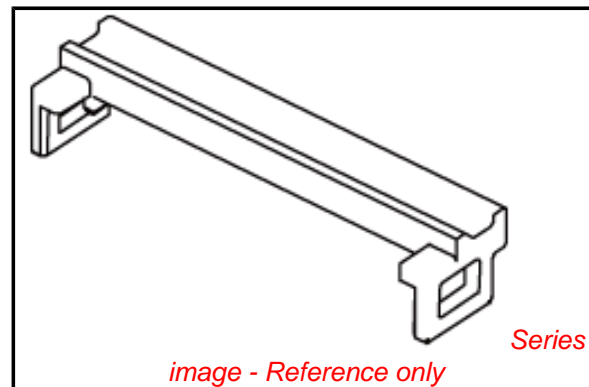

EU RoHS

**ELV and RoHS
Compliant**
**REACH SVHC
Contains SVHC: No
Halogen-Free
Status
Not Reviewed**

China RoHS



**Need more information on product
environmental compliance?**

Email productcompliance@molex.com
 For a multiple part number RoHS Certificate of
 Compliance, [click here](#)

Please visit the [Contact Us](#) section for any
 non-product compliance questions.

Search Parts in this Series

501784Series

Use With

501786 FFC-to-Board Connector, 501864
 FFC-to-Board Connector, 501783 Plug
 Jacket

PLEASE CHECK WWW.MOLEX.COM FOR LATEST PART INFORMATION

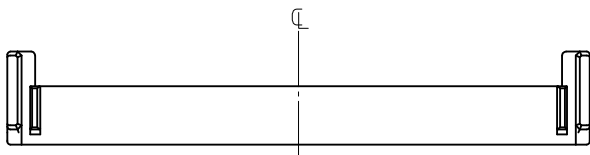
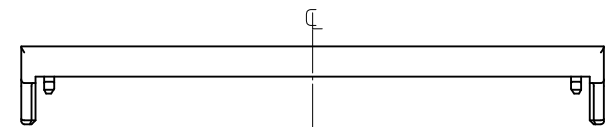
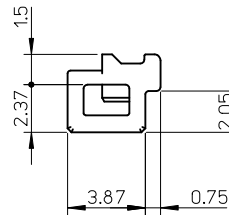
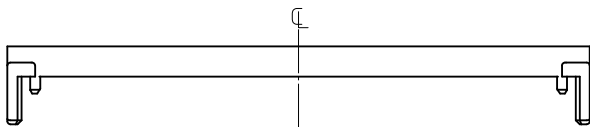
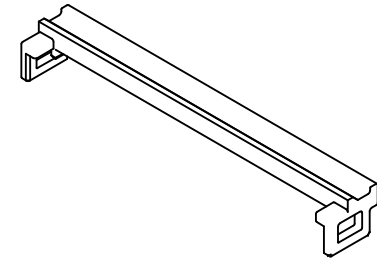
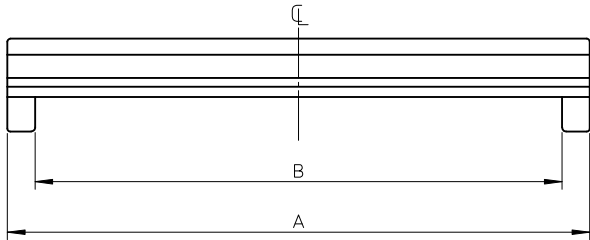

41.2	43.96	501784-8009	80
26.2	28.96	501784-5009	50
B	A	PLASTIC BAG PACKAGE	極数
		オーダー番号 ORDER NO.	CIRCUITS
CONNECTOR SERIES NO. 501784-**09			

注記
NOTES

- 適合プラグジャケット: 501783-**09
APPLICABLE PLUG JACKET : 501783-**09
- 材質
MATERIAL
PBT, UL94V-0, 色: 黒色
PBT, UL94V-0, COLOR: BLACK

REVISED EC NO.: J2010-1937 DRWN: YMORI 2010/03/26 CHKD: MATSUURA 2010/03/26 APPR: KMORIKAWA 2010/05/10	DESCRIPTION	GENERAL TOLERANCES (UNLESS SPECIFIED)		DIMENSION STYLE MM ONLY		SCALE --//	DESIGN UNITS METRIC	THIRD ANGLE PROJECTION
		10 UNDER	±0.2	DRAWN BY H. IJIMA	DATE 06/01/16	TITLE 0.5 FFC TO BOARD CONN PLUG JACKET COVER		
		10 OVER 30 UNDER	±0.25	CHECKED BY K. TAKAHASHI	DATE 06/01/16	APPROVED BY H. HIRATA		
		30 OVER	±0.3	MATERIAL NO. 501784-**09		DOCUMENT NO. SD-501784-001		
A	REV	ANGULAR ±1 ° DRAFT WHERE APPLICABLE MUST REMAIN WITHIN DIMENSIONS		SIZE A3	THIS DRAWING CONTAINS INFORMATION THAT IS PROPRIETARY TO MOLEX INCORPORATED AND SHOULD NOT BE USED WITHOUT WRITTEN PERMISSION			SHEET NO. 1 OF 1