

PLEASE CHECK WWW.MOLEX.COM FOR LATEST PART INFORMATION

Part Number: [0311010042](#)
Status: **Active**
Overview: [hdac 64 single row](#)
Description: H-DAC 64™ 2.54mm (.100") 4 Way Vertical Header Assembly, Polarization C

Documents:

[Drawing \(PDF\)](#) [Product Specification PS-31100-0001 \(PDF\)](#)
[Application Specification \(PDF\)](#) [RoHS Certificate of Compliance \(PDF\)](#)

General

Product Family	PCB Headers
Series	31101
Application	Wire-to-Board
Comments	Polarization Option C, Brown
Overview	hdac 64 single row
Product Name	H-DAC 64™

Physical

Breakaway	No
Circuits (Loaded)	4
Circuits (maximum)	4
Color - Resin	Brown
Durability (mating cycles max)	10
First Mate / Last Break	No
Glow-Wire Compliant	No
Guide to Mating Part	No
Keying to Mating Part	None
Lock to Mating Part	Yes
Material - Metal	Brass
Material - Plating Mating	Tin
Material - Plating Termination	Nickel
Material - Resin	Modified Polystyrene
Number of Rows	1
Orientation	Right Angle
PC Tail Length (in)	0.145 In
PC Tail Length (mm)	3.68 mm
PCB Locator	Yes
PCB Retention	Yes
PCB Thickness Recommended (in)	0.062 In
PCB Thickness Recommended (mm)	1.57 mm
Packaging Type	Tray
Pitch - Mating Interface (in)	0.100 In
Pitch - Mating Interface (mm)	2.54 mm
Pitch - Term. Interface (in)	0.100 In
Pitch - Term. Interface (mm)	2.54 mm
Plating min: Mating (µin)	60
Plating min: Mating (µm)	1.50
Plating min: Termination (µin)	60
Plating min: Termination (µm)	1.50
Polarized to Mating Part	Yes
Polarized to PCB	Yes
Shrouded	Closed Ends
Stackable	No
Surface Mount Compatible (SMC)	No
Temperature Range - Operating	-40°C to +100°C
Termination Interface: Style	Through Hole

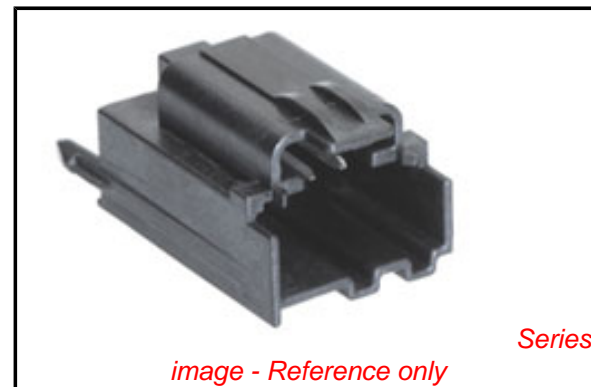

EU RoHS

ELV and RoHS Compliant
REACH SVHC Contains SVHC: No
Halogen-Free Status
Not Reviewed

China RoHS



Need more information on product environmental compliance?

Email productcompliance@molex.com
 For a multiple part number RoHS Certificate of Compliance, [click here](#)

Please visit the [Contact Us](#) section for any non-product compliance questions.

Search Parts in this Series

[31101Series](#)

Mates With

H-DAC 64™, 4 Way Receptacle Assembly
[310681012](#)

Electrical

Current - Maximum per Contact	5A, 7A
Voltage - Maximum	500V DC

Solder Process Data

Duration at Max. Process Temperature (seconds)	40
Lead-free Process Capability	SMC & Wave Capable (TH only)
Max. Cycles at Max. Process Temperature	3
Process Temperature max. C	260

Material Info**Reference - Drawing Numbers**

Application Specification	AS-31067-100
Packaging Specification	PK-31300-707
Product Specification	PS-31100-0001
Sales Drawing	SD-31206-003

This document was generated on 05/24/2010

PLEASE CHECK WWW.MOLEX.COM FOR LATEST PART INFORMATION

3 WAY VERTICAL
HEADER ASSEMBLY
(POLARIZATION OPTIONS)
VIEWED FROM MATE SIDE

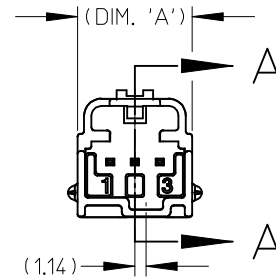
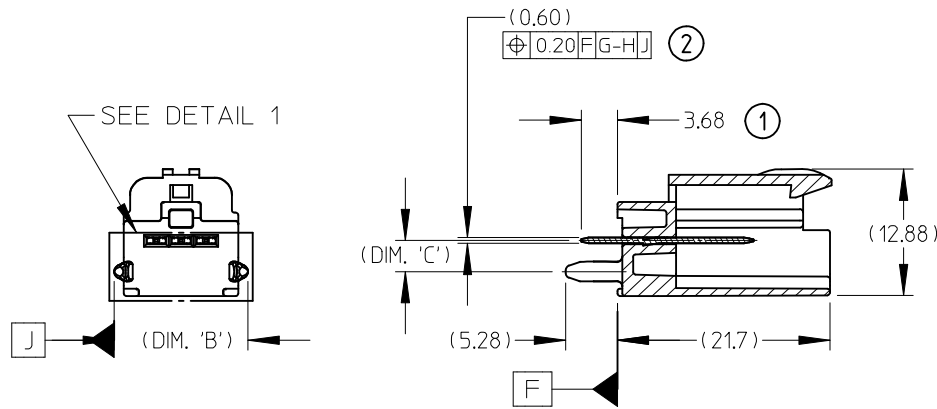
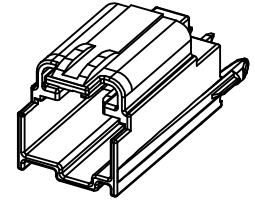
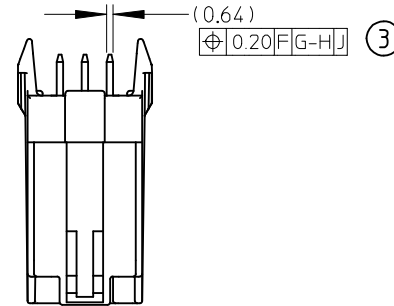

OPTION "A"

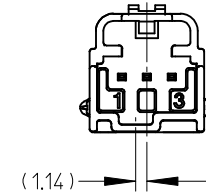

OPTION "B"
VIEWED FROM MATE SIDE

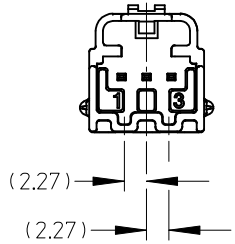

OPTION "C"

NOTES:

- MATERIAL:
HOUSING: SYNDIOTATIC POLYSTYRENE (SPS).
COLOR: SEE CHART.
TERMINAL: BRASS.
- FINISH:
TERMINAL: 60 MICROINCHES MIN NICKEL (Ni)
UNDERPLATE OVERALL. 60 MICROINCHES MIN
SELECTIVE TIN (Sn).
- PRODUCT SPEC NUMBER PS-31100-0001.
- PACKAGING PER PACKAGING SPEC.: PK-31300-293.
- MATES WITH SEE CHART.

SECTION A-A

ENTER DESCRIPTION EC NO: UAU2009-0141 DRW:CD/ILLON 2008/09/15 CHKD:CD/ILLON 2008/09/15 APPR:SMARCEAU 2008/09/15	QUALITY SYMBOLS ▽=0 ▽7=0	GENERAL TOLERANCES (UNLESS SPECIFIED) mm INCH 4 PLACES ± --- ± --- 3 PLACES ± --- ± --- 2 PLACES ± 0.13 ± --- 1 PLACE ± 0.25 ± --- ANGULAR ± 1/2°	DIMENSION STYLE MM ONLY DRAWN BY DATE MDEVITO 2/02/06 CHECKED BY DATE GMEYER 2/02/06 APPROVED BY DATE GMEYER 2/02/06	SCALE 2:1 DESIGN UNITS METRIC THIRD ANGLE PROJECTION	TITLE VERTICAL HEADER ASSEMBLY CHARTED SALES DRAWING	
	MATERIAL NO. SEE CHART	DOCUMENT NO. SD-31206-003	SHEET NO. 1 OF 7			
	DRAFT WHERE APPLICABLE MUST REMAIN WITHIN DIMENSIONS			MOLEX INCORPORATED		
	THIS DRAWING CONTAINS INFORMATION THAT IS PROPRIETARY TO MOLEX INCORPORATED AND SHOULD NOT BE USED WITHOUT WRITTEN PERMISSION					

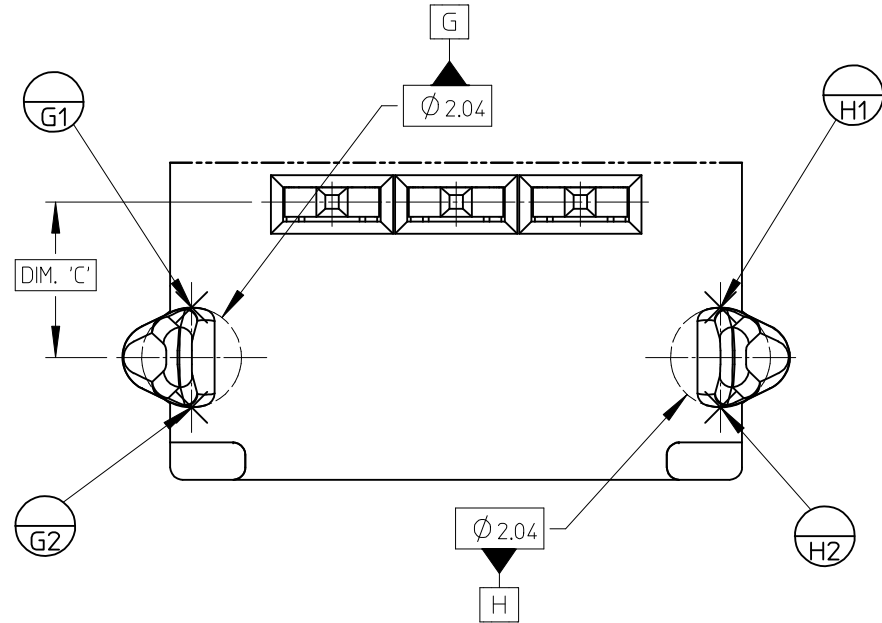

DETAIL 1
SCALE 10:1

FULLY MATED ASSMBLY

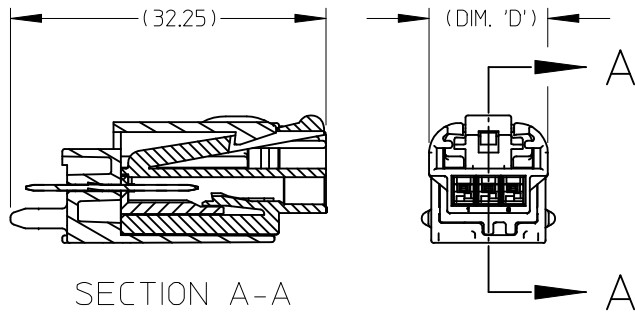

ENTER DESCRIPTION EC NO: UAU2009-0141 DRAWN: CDILLON 2008/09/15 CHKD: CDILLON 2008/09/15 APPR: SMARCEAU 2008/09/15	QUALITY SYMBOLS ▽=0 ▽=0	GENERAL TOLERANCES (UNLESS SPECIFIED) mm INCH 4 PLACES ± --- ± --- 3 PLACES ± --- ± --- 2 PLACES ± 0.13 ± --- 1 PLACE ± 0.25 ± --- ANGULAR ± 1/2°	DIMENSION STYLE MM ONLY DRAWN BY DATE MDEVITO 2/02/06 CHECKED BY DATE GMEYER 2/02/06 APPROVED BY DATE GMEYER 2/02/06	SCALE 1:1 DESIGN UNITS METRIC THIRD ANGLE PROJECTION	TITLE VERTICAL HEADER ASSEMBLY CHARTED SALES DRAWING
	DRAFT WHERE APPLICABLE MUST REMAIN WITHIN DIMENSIONS	MATERIAL NO. SEE CHART	DOCUMENT NO. SD-31206-003	SHEET NO. 2 OF 7	
	THIS DRAWING CONTAINS INFORMATION THAT IS PROPRIETARY TO MOLEX INCORPORATED AND SHOULD NOT BE USED WITHOUT WRITTEN PERMISSION				
	MOLEX INCORPORATED				

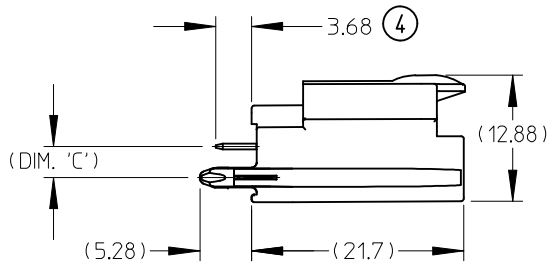

4 WAY VERTICAL
HEADER ASSEMBLY
(POLARIZATION OPTIONS)
VIEWED FROM MATE SIDE

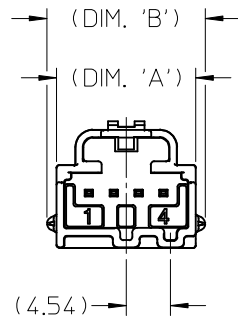

OPTION "A"

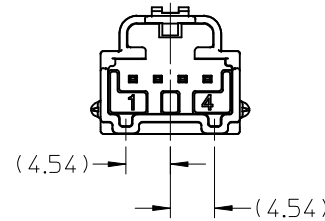

OPTION "B"
VIEWED FROM MATE SIDE

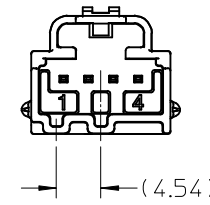

OPTION "C"

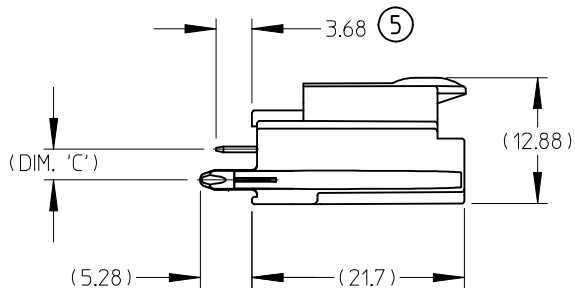
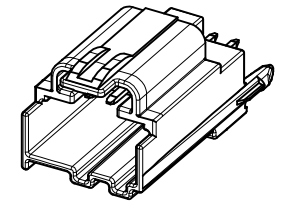

5 WAY VERTICAL
HEADER ASSEMBLY
(POLARIZATION OPTIONS)
VIEWED FROM MATE SIDE

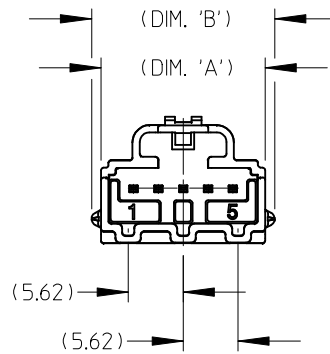

OPTION "A"

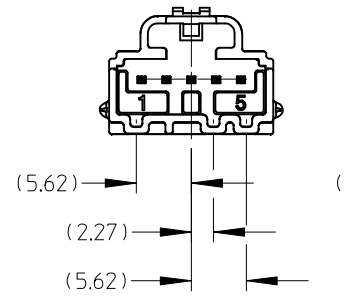

OPTION "B"
VIEWED FROM MATE SIDE

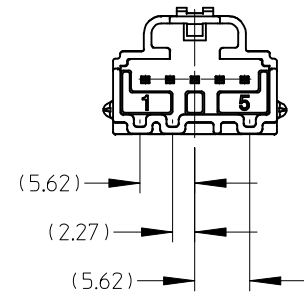

OPTION "C"

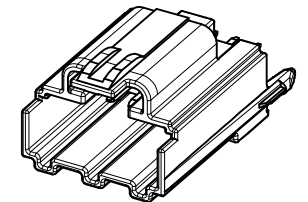

ENTER DESCRIPTION EC NO: UAU2009-0141 DRWN:CDILLON 2008/09/15 CHKD:CDILLON 2008/09/15 APPR:SMARCEAU 2008/09/15 H	DESCRIPTION REV	QUALITY SYMBOLS ▽=0 ▽=0	GENERAL TOLERANCES (UNLESS SPECIFIED)		DIMENSION STYLE MM ONLY		SCALE 1:1	DESIGN UNITS METRIC	THIRD ANGLE PROJECTION	
			4 PLACES ± --- ± --- 3 PLACES ± --- ± --- 2 PLACES ± 0.13 ± --- 1 PLACE ± 0.25 ± ---	mm INCH	DRAWN BY MDEVITO	DATE 2/02/06	TITLE VERTICAL HEADER ASSEMBLY CHARTED SALES DRAWING			
			ANGULAR ± 1/2°	CHECKED BY GMEYER	DATE 2/02/06					
		DRAFT WHERE APPLICABLE MUST REMAIN WITHIN DIMENSIONS	MATERIAL NO. SEE CHART	APPROVED BY GMEYER	DATE 2/02/06	MOLEX INCORPORATED		DOCUMENT NO. SD-31206-003	SHEET NO. 3 OF 7	
THIS DRAWING CONTAINS INFORMATION THAT IS PROPRIETARY TO MOLEX INCORPORATED AND SHOULD NOT BE USED WITHOUT WRITTEN PERMISSION										

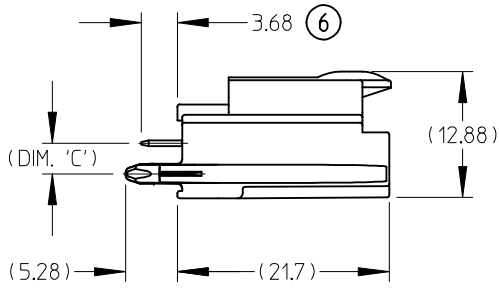

6 WAY VERTICAL
HEADER ASSEMBLY
(POLARIZATION OPTIONS)
VIEWED FROM MATE SIDE

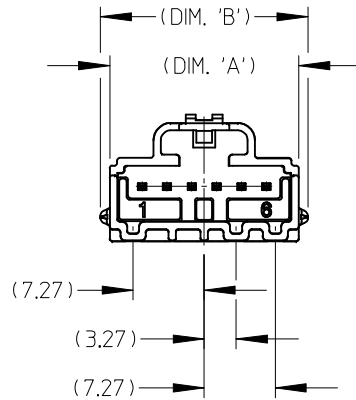

OPTION "A"

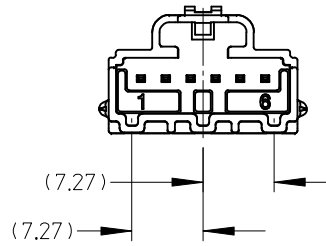

OPTION "B"
VIEWED FROM MATE SIDE

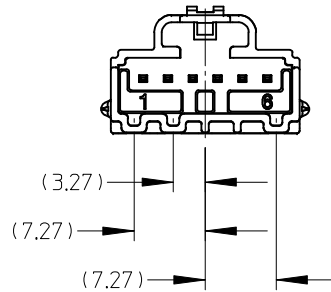

OPTION "C"

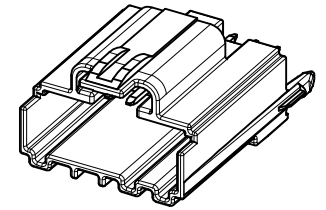

ENTER DESCRIPTION EC NO: UAU2009-0141 DRWN:CDILLON 2008/09/15 CHKD:CDILLON 2008/09/15 APPR:SMARCEAU 2008/09/15	QUALITY SYMBOLS ▽=0 ▽=0	GENERAL TOLERANCES (UNLESS SPECIFIED)		DIMENSION STYLE MM ONLY		SCALE 2:1	DESIGN UNITS METRIC	THIRD ANGLE PROJECTION		
		4 PLACES ± --- ± ---	mm INCH	DRAWN BY MDEVITO	DATE 2/02/06	TITLE VERTICAL HEADER ASSEMBLY CHARTED SALES DRAWING				
		3 PLACES ± --- ± ---	2 PLACES ± 0.13 ± ---	CHECKED BY GMEYER	DATE 2/02/06					
		1 PLACE ± 0.25 ± ---	ANGULAR ± 1/2°	APPROVED BY GMEYER	DATE 2/02/06	MATERIAL NO. SEE CHART		DOCUMENT NO. SD-31206-003	MOLEX INCORPORATED	
DRAFT WHERE APPLICABLE MUST REMAIN WITHIN DIMENSIONS		SIZE B	THIS DRAWING CONTAINS INFORMATION THAT IS PROPRIETARY TO MOLEX INCORPORATED AND SHOULD NOT BE USED WITHOUT WRITTEN PERMISSION					SHEET NO. 4 OF 7		

BILL OF MATERIALS

BILL OF MATERIALS

FEMALE MATING ASSEMBLY	HEADER ASSEMBLY PART NO.	DESCRIPTION	COLOR	DIM. 'A'	DIM. 'B'	DIM. 'C'	DIM. 'D'	FEMALE MATING ASSEMBLY	HEADER ASSEMBLY PART NO.	DESCRIPTION	COLOR	DIM. 'A'	DIM. 'B'	DIM. 'C'	DIM. 'D'
31067-1010	31101-0030 NOT TOOLED	3 WAY VERTICAL HEADER ASSEMBLY POLARIZATION "A"	BLACK	11.69	13.66	3.18	12.14	31072-1010	31101-0050 NOT TOOLED	5 WAY VERTICAL HEADER ASSEMBLY POLARIZATION "A"	BLACK	16.77	18.74	3.13	17.22
			N/A								N/A				
			GRAY								GRAY				
31067-1011	31101-0031 NOT TOOLED	3 WAY VERTICAL HEADER ASSEMBLY POLARIZATION "B"	GRAY	11.69	13.66	3.18	12.14	31072-1011	31101-0051 NOT TOOLED	5 WAY VERTICAL HEADER ASSEMBLY POLARIZATION "B"	GRAY	16.77	18.74	3.13	17.22
			N/A								N/A				
31067-1012	31101-0032 NOT TOOLED	3 WAY VERTICAL HEADER ASSEMBLY POLARIZATION "C"	BROWN	11.69	13.66	3.18	12.14	31072-1012	31101-0052 NOT TOOLED	5 WAY VERTICAL HEADER ASSEMBLY POLARIZATION "C"	BROWN	16.77	18.74	3.13	17.22
			N/A								N/A				
31068-1010	31101-0040	4 WAY VERTICAL HEADER ASSEMBLY POLARIZATION "A"	BLACK	14.23	16.20	3.18	14.68	31073-1010	31101-0060 NOT TOOLED	6 WAY VERTICAL HEADER ASSEMBLY POLARIZATION "A"	BLACK	19.31	21.28	3.13	19.76
			N/A								N/A				
			GRAY								GRAY				
31068-1011	31101-0041	4 WAY VERTICAL HEADER ASSEMBLY POLARIZATION "B"	GRAY	14.23	16.20	3.18	14.68	31073-1011	31101-0061 NOT TOOLED	6 WAY VERTICAL HEADER ASSEMBLY POLARIZATION "B"	GRAY	19.31	21.28	3.13	19.76
			N/A								N/A				
31068-1012	31101-0042	4 WAY VERTICAL HEADER ASSEMBLY POLARIZATION "C"	BROWN	14.23	16.20	3.18	14.68	31073-1012	31101-0062 NOT TOOLED	6 WAY VERTICAL HEADER ASSEMBLY POLARIZATION "C"	BROWN	19.31	21.28	3.13	19.76
			N/A								N/A				

ENTER DESCRIPTION EC NO: UAU2009-0141 DRWN:CDILLON 2008/09/15 CHKD:CDILLON 2008/09/15 APPR:SMARCEAU 2008/09/15 REV DESCRIPTION	QUALITY SYMBOLS	GENERAL TOLERANCES (UNLESS SPECIFIED)	DIMENSION STYLE	SCALE	DESIGN UNITS	THIRD ANGLE PROJECTION
	▽=0 ▽=0	mm INCH	MM ONLY	1:1	METRIC	
		4 PLACES ± --- ± ---	DRAWN BY DATE	TITLE VERTICAL HEADER ASSEMBLY CHARTED SALES DRAWING		
		3 PLACES ± --- ± ---	MDEVITO 2/02/06			
		2 PLACES ± 0.13 ± ---	CHECKED BY DATE	MOLEX INCORPORATED		
	1 PLACE ± 0.25 ± ---	GMEYER 2/02/06				
	ANGULAR ± 1/2°	APPROVED BY DATE	DOCUMENT NO. SD-31206-003			
		GMEYER 2/02/06				
		MATERIAL NO.	SHEET NO. 5 OF 7			
		SEE CHART				
		SIZE B	THIS DRAWING CONTAINS INFORMATION THAT IS PROPRIETARY TO MOLEX INCORPORATED AND SHOULD NOT BE USED WITHOUT WRITTEN PERMISSION			

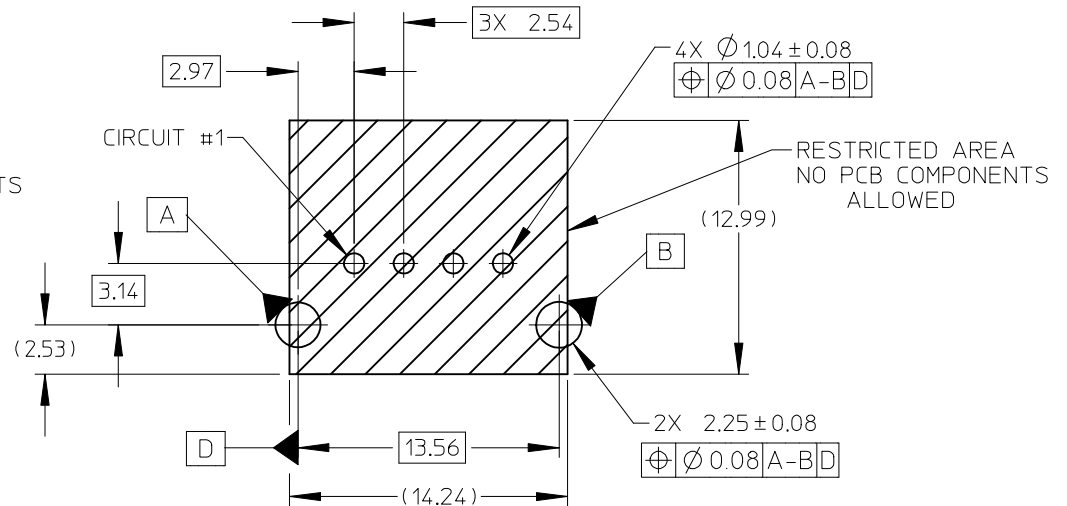
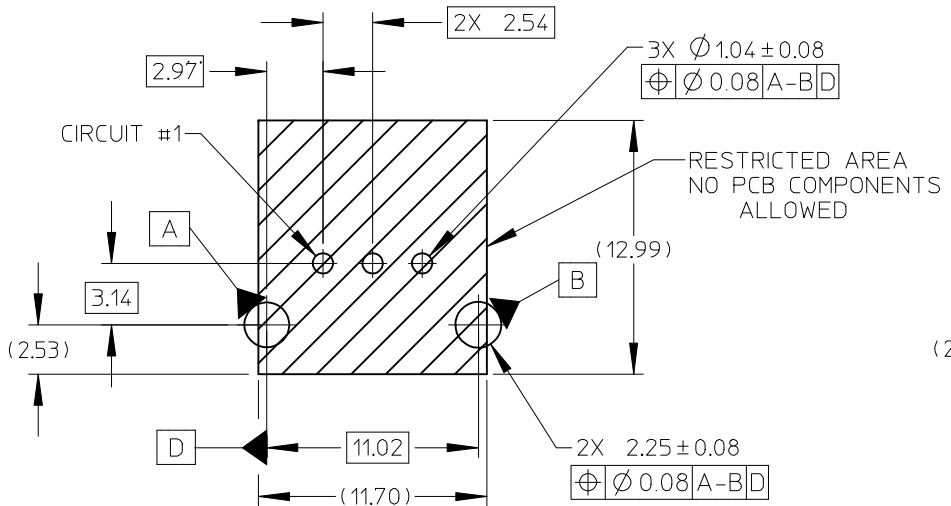

3 Way PCB Layout Component Side
 RECOMMENDED PCB THICKNESS 1.57±0.17

4 Way PCB Layout Component Side
 RECOMMENDED PCB THICKNESS 1.57±0.17

ENTER DESCRIPTION EC NO: UAU2009-0141 DRAWN: CDILLON 2008/09/15 CHKD: CDILLON 2008/09/15 APPR: SMARCEAU 2008/09/15	QUALITY SYMBOLS ▽=0 ▽=0	GENERAL TOLERANCES (UNLESS SPECIFIED)		DIMENSION STYLE MM ONLY		SCALE	DESIGN UNITS METRIC	THIRD ANGLE PROJECTION		
		4 PLACES	± ---	± ---	DRAWN BY	DATE	TITLE VERTICAL HEADER ASSEMBLY CHARTED SALES DRAWING			
		3 PLACES	± ---	± ---	MDEVITO	2/02/06				
		2 PLACES	± 0.13	± ---	CHECKED BY	DATE	MOLEX INCORPORATED			
		1 PLACE	± 0.25	± ---	GMEYER	2/02/06				
ANGULAR ±1/2°		DRAFT WHERE APPLICABLE MUST REMAIN WITHIN DIMENSIONS		MATERIAL NO. SEE CHART		DOCUMENT NO. SD-31206-003		SHEET NO. 6 OF 7		
THIS DRAWING CONTAINS INFORMATION THAT IS PROPRIETARY TO MOLEX INCORPORATED AND SHOULD NOT BE USED WITHOUT WRITTEN PERMISSION										

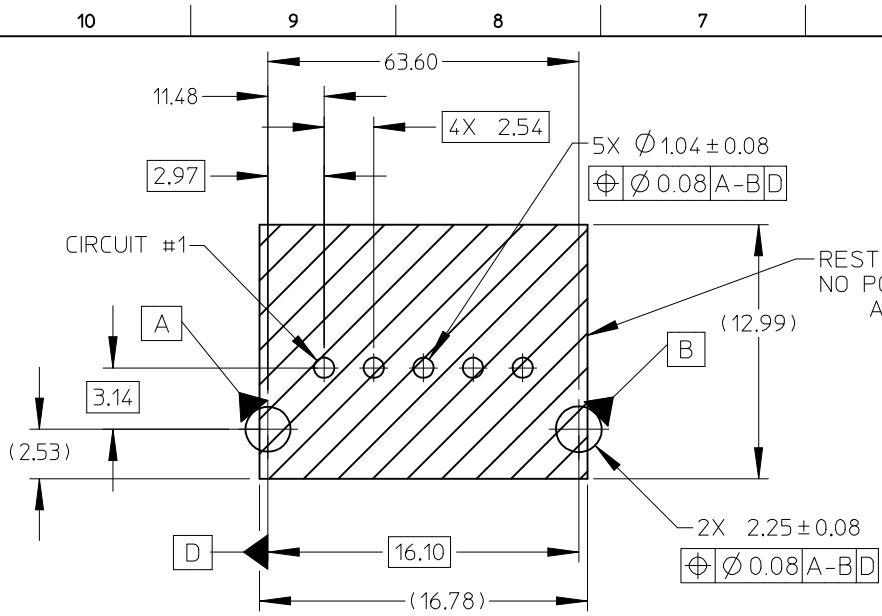

5 WAY PCB LAYOUT COMPONENT SIDE
RECOMENDED PCB THICKNESS 1.57±0.17

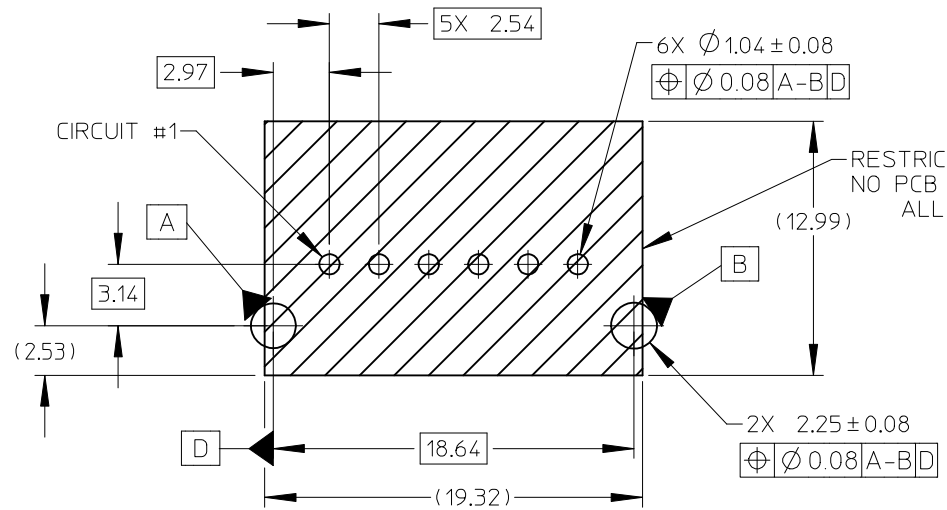

6 WAY PCB LAYOUT COMPONENT SIDE
RECOMENDED PCB THICKNESS 1.57±0.17

ENTER DESCRIPTION EC NO: UAU2009-0141 DRAWN: COILLON 2008/09/15 CHKD: COILLON 2008/09/15 APPR: SMARCEAU 2008/09/15	QUALITY SYMBOLS ▽=0 ▽=0	GENERAL TOLERANCES (UNLESS SPECIFIED)		DIMENSION STYLE MM ONLY		SCALE 1:1	DESIGN UNITS METRIC	THIRD ANGLE PROJECTION		
		4 PLACES	± ---	± ---	DRAWN BY	DATE	TITLE VERTICAL HEADER ASSEMBLY CHARTED SALES DRAWING			
		3 PLACES	± ---	± ---	MDEVITO	2/02/06				
		2 PLACES	± 0.13	± ---	CHECKED BY	DATE	MOLEX INCORPORATED			
1 PLACE	± 0.25	± ---	GMEYER	2/02/06						
ANGULAR ±1/2°		APPROVED BY		DATE	DOCUMENT NO.		SHEET NO.			
DRAFT WHERE APPLICABLE MUST REMAIN WITHIN DIMENSIONS		SEE CHART		SD-31206-003		7 OF 7				
THIS DRAWING CONTAINS INFORMATION THAT IS PROPRIETARY TO MOLEX INCORPORATED AND SHOULD NOT BE USED WITHOUT WRITTEN PERMISSION										