

Negative Output Low Drop Out voltage regulator

■ GENERAL DESCRIPTION

The NJM2827 is a negative output low dropout regulator. Advanced bipolar technology achieves low noise, high precision voltage and high ripple rejection.

It has soft-start and shunt SW function. 1.0 μ F Output capacitor and small package can make NJM2827 suitable for portable items.

■ PACKAGE OUTLINE

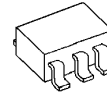

NJM2827F3

■ FEATURES

- Low Dropout Voltage :0.13V (typ.) @ $I_o=60\text{mA}$
- High Precision Output : $\pm 1.5\%$
- High Ripple Rejection :65dB(typ.) @ $f=1\text{kHz}$, $V_o=-7\text{V}$ Version
- Output capacitor with 1.0 μ F ceramic capacitor.
- Output Current : $I_o(\text{max.})=100\text{mA}$
- Soft-start Function
- Shunt SW Function
- Internal Thermal Overload Protection
- Internal Short Circuit Current Limit
- Bipolar Technology
- Package Outline SC88A

■ PIN CONFIGURATION

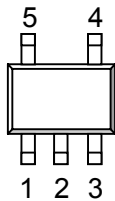

- 1.GND
- 2. V_{IN}
- 3. V_{OUT}
- 4.NC
- 5.CS

NJM2827F3-XX

■ EQUIVALENT CIRCUIT

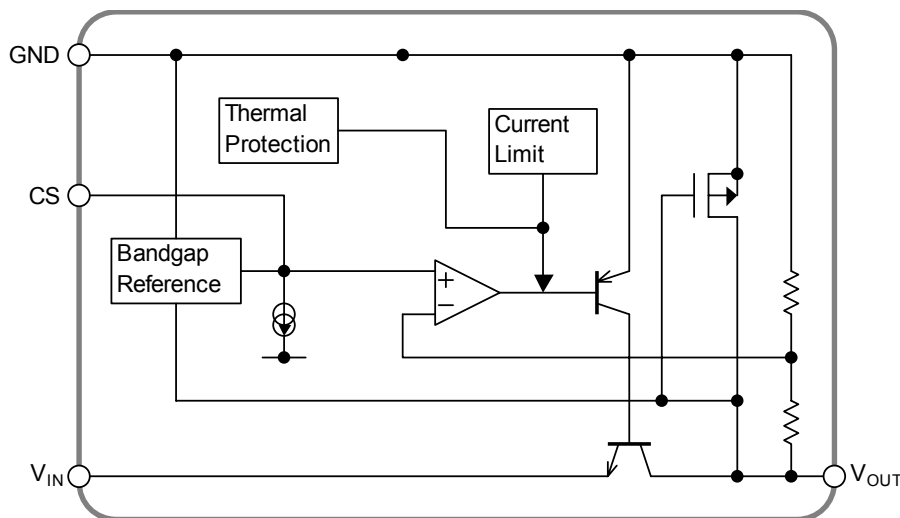

NJM2827

■ OUTPUT VOLTAGE RANK LIST

Device Name	V _{out}
NJM2827F3 -14	-1.4V
NJM2827F3 -15	-1.5V
NJM2827F3 -05	-5.0V
NJM2827F3 -06	-6.0V
NJM2827F3 -07	-7.0V
NJM2827F3 -75	-7.5V
NJM2827F3 -08	-8.0V
NJM2829F3 -10	-10.0V

Output voltage options available: -1.5 ~ -10.0V

■ ABSOLUTE MAXIMUM RATINGS (Ta=25°C)

PARAMETER	SYMBOL	RATINGS	UNIT
Input Voltage	V _{IN}	-14	V
Power Dissipation	P _D	250(*1)	mW
Operating Temperature	T _{opr}	-40 ~ +85	°C
Storage Temperature	T _{stg}	-40 ~ +125	°C

(*1): Mount on EIA/JEDEC STANDARD Test board (76.2*114.3*1.6mm, 2layers, FR-4)

■ Operating voltage

V_{IN}=-3.2 ~ -12V (In case of Vo>-3.0V version)

■ ELECTRICAL CHARACTERISTICS

(Vo<-2.2V Version: V_{IN}=Vo-1V, C_{IN}=0.1μF, Co=1.0μF, Ta=25°C)

(Vo≥-2.2V Version: V_{IN}=-3.2V, C_{IN}=0.1μF, Co=2.2μF (Vo>-2.0V: Co=4.7μF), Ta=25°C)

PARAMETER	SYMBOL	TEST CONDITION	MIN.	TYP.	MAX.	UNIT
Output Voltage	V _o	I _o =30mA	+1.5%	-	-1.5%	V
Quiescent Current	I _Q	I _o =0mA	-	130	200	μA
Output Current	I _o	V _O +0.3V	100	130	-	mA
Line Regulation	ΔV _o /ΔV _{IN}	V _{IN} =Vo-1V ~ -12V (V _O < -2.2V) V _{IN} =-3.2V ~ -12V (V _O ≥ -2.2V) I _o =30mA	-	-	0.10	%/V
Load Regulation	ΔV _o /ΔI _o	I _o =0~60mA	-	-	0.03	%/mA
Dropout Voltage(*2)	ΔV _{I O}	I _o =60mA	-	0.13	0.23	V
Ripple Rejection	RR	V _{IN} =Vo-1V ~ -12V (V _O ≤ -3.0V) V _{IN} =-4.0V ~ -12V (V _O > -3.0V) e _{in} =200mVrms, f=1kHz, I _o =10mA, Vo=-7V Version	-	65	-	dB
Average Temperature Coefficient of Output Voltage	ΔV _o /ΔTa	Ta=0 ~ 85°C, I _o =10mA	-	±50	-	ppm/°C
Output Noise Voltage	V _{NO}	f=10Hz~80kHz, I _o =10mA, Vo=-7V Version	-	100	-	μVrms
CS Terminal Charge Current	I _{CS}	V _{CS} =0V	4	5	6	μA
Input Voltage	V _{IN}		-12	-	-	V

(*2): Excludes Vo>-3.0V version.

The above specification is a common specification for all output voltages.

Therefore, it may be different from the individual specification for a specific output voltage.

■ TEST CIRCUIT

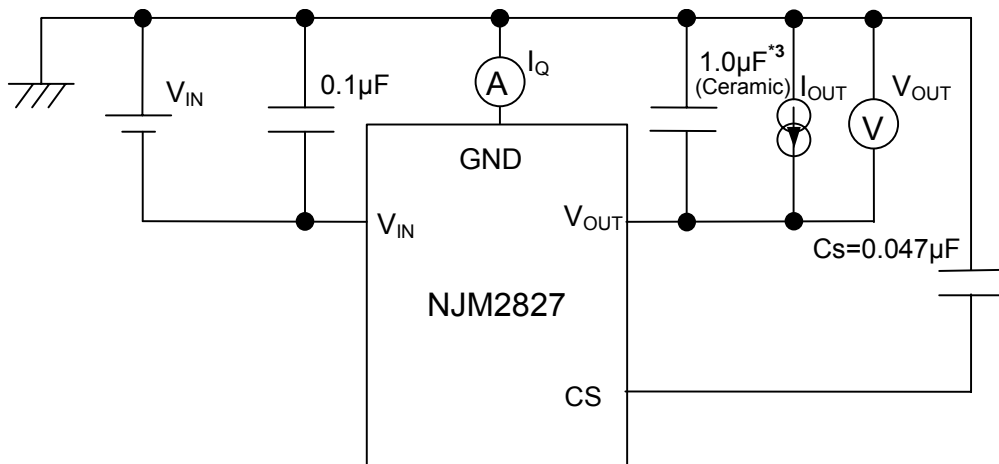

*3 $-2.2\text{V} \leq V_o \leq -2.0\text{V}$ version: $C_o = 2.2\mu\text{F}$ (Ceramic)
 $V_o > -2.0\text{V}$ version: $C_o = 4.7\mu\text{F}$ (Ceramic)

NJM2827

■ TYPICAL APPLICATIONS

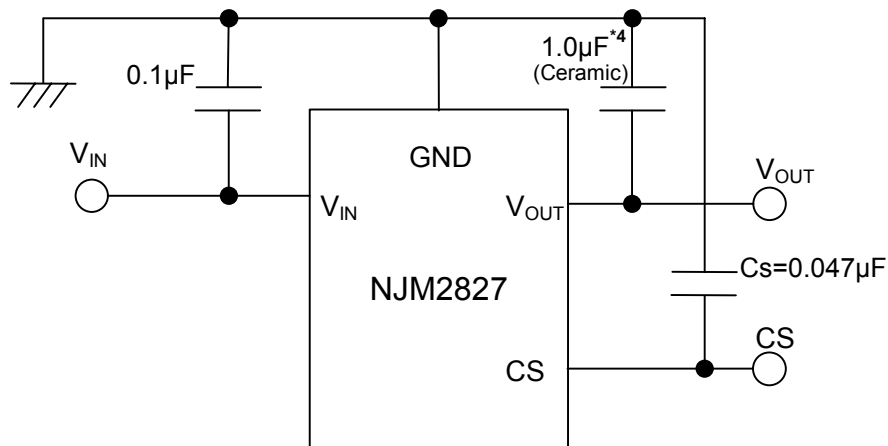

*4 $-2.2V \leq V_O \leq -2.0V$ version: $C_o = 2.2\mu F$ (Ceramic)
 $V_O > -2.0V$ version: $C_o = 4.7\mu F$ (Ceramic)

*Input Capacitance C_{IN}

Input capacitance C_{IN} is required to prevent oscillation and reduce power supply ripple for applications with high power supply impedance or a long power supply line.

Use the C_{IN} value of $0.1\mu F$ greater to avoid the problem.

C_{IN} should connect between GND and V_{IN} as short as possible.

*Output Capacitance C_O

Output capacitor (C_o) is required for a phase compensation of the internal error amplifier. The capacitance and the equivalent series resistance (ESR) influences stability of the regulator.

This product is designed to work with a low ESR capacitor for the C_o ; however, use of recommended capacitance or greater value is essential for stable operation.

Use of a smaller C_o may cause excess output noise or oscillation of the regulator due to lack of the phase compensation.

Therefore, use C_o with the recommended capacitance or greater value and connect between V_o terminal and GND terminal with minimal wiring. The recommended capacitance depends on the output voltage. Low voltage regulator requires greater value of the C_o . Thus, check the recommended capacitance for each output voltage.

Use of a greater C_o reduces output noise and ripple output, and also improves transient response of the output voltage against rapid load change.

*Soft-start function

Capacitance C_s connect between CS pin and GND for the following.

- Control at risetime of output voltage.
- Reduces inrush current at output ON.

When the soft start function is not used, CS pin should be open.

1. C_s capacitance vs risetime of output voltage

Calculation : risetime of output voltage $\Delta t \cong 213 \times C_s(\mu\text{F})$

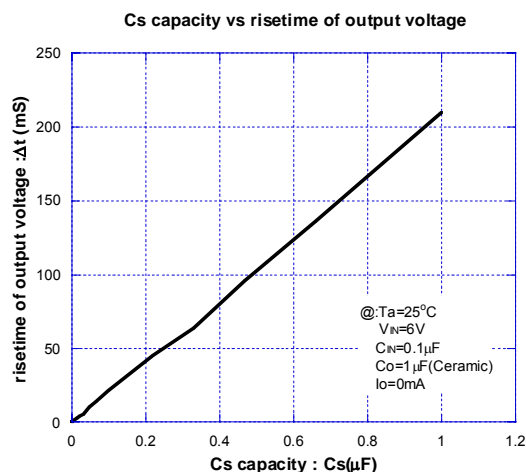

2. Inrush current at control ON

The peak value of the inrush current can be limited according to the capacitance of the C_s .

Inrush current wave :

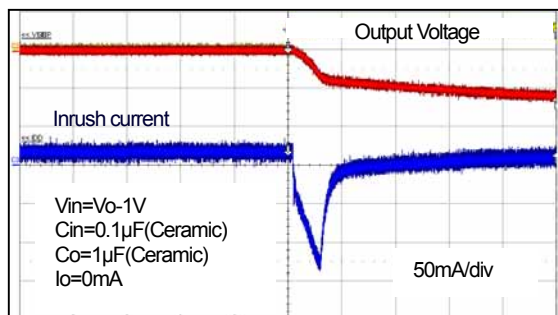

Inrush Peak Current=150mA(Cs=Open)

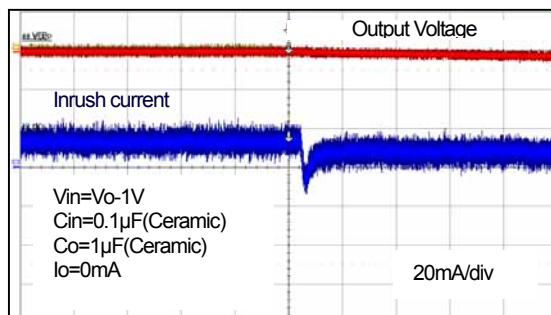

Inrush Peak Current=20mA(Cs=0.0047μF)

* This characteristic is one example. It is necessary to examine the characteristic with an actual circuit because there is an influence by the characteristic such as output voltage/output capacitor.

■ POWER DISSIPATION vs. AMBIENT TEMPERATURE

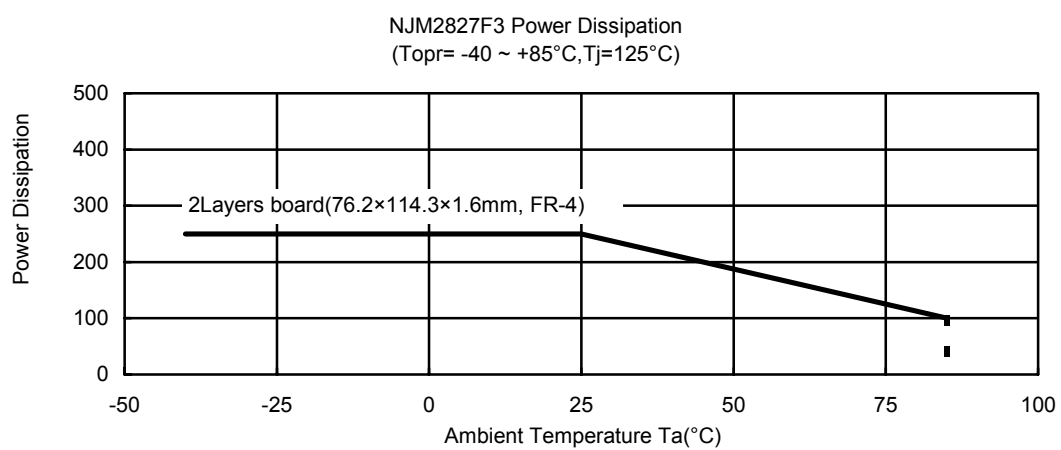

TYPICAL CHARACTERISTICS

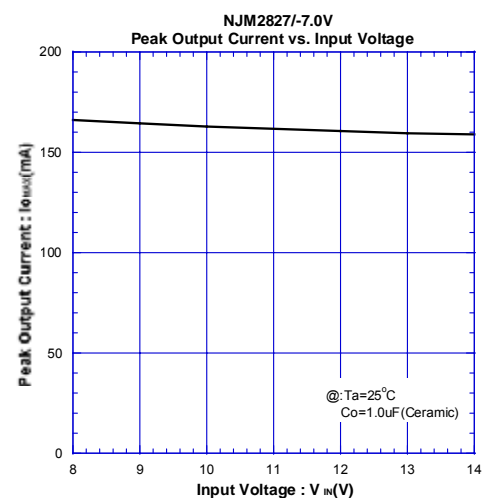
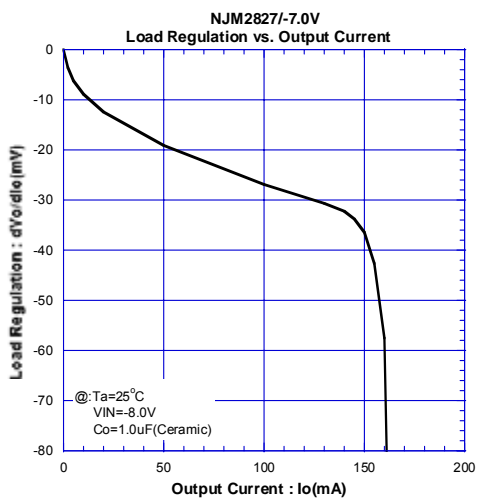
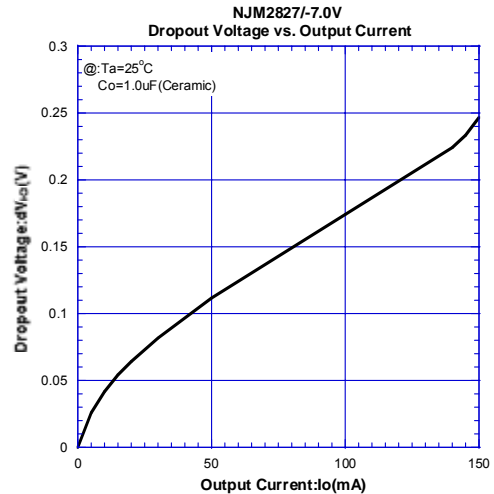
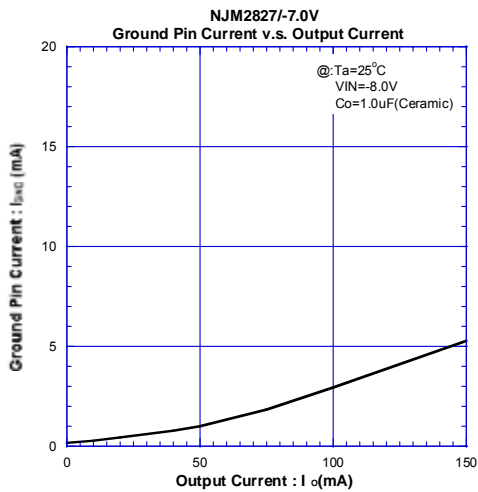
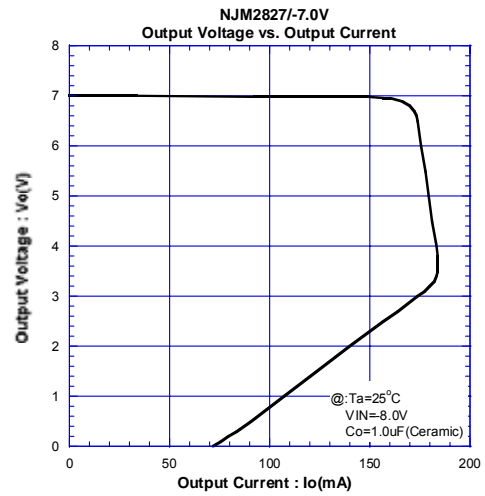
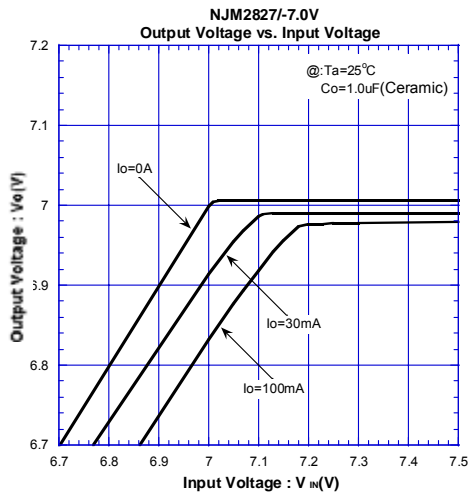

NJM2827

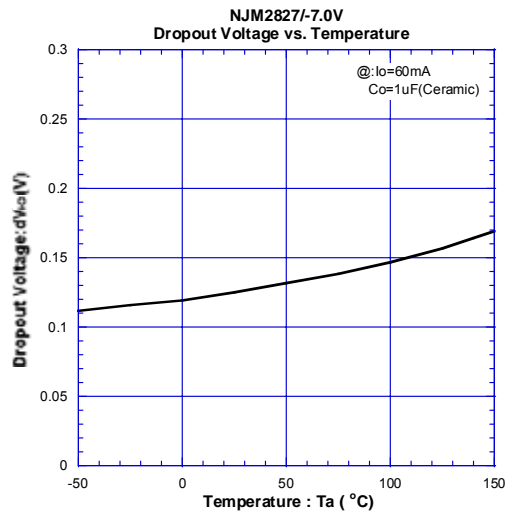
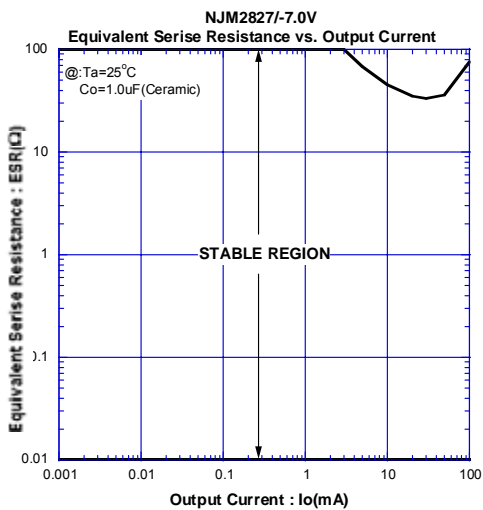
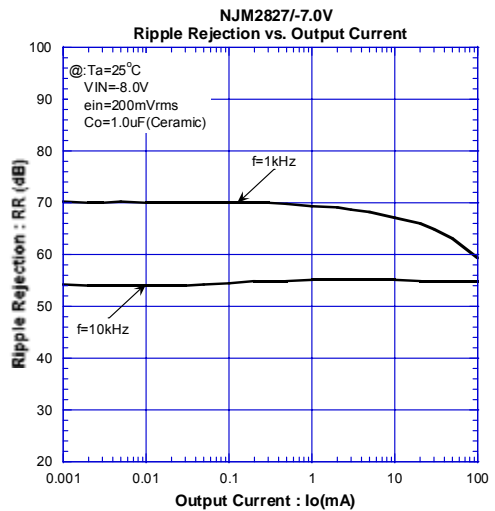
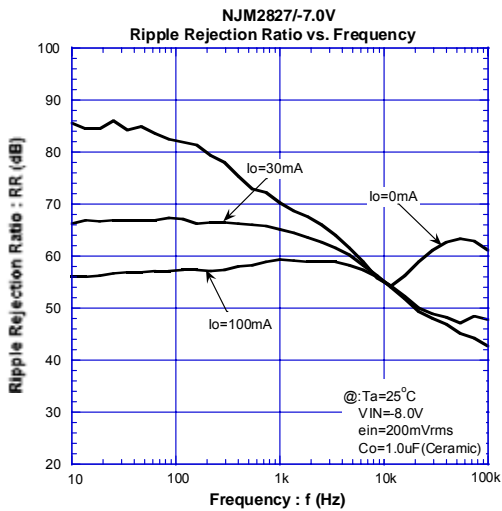
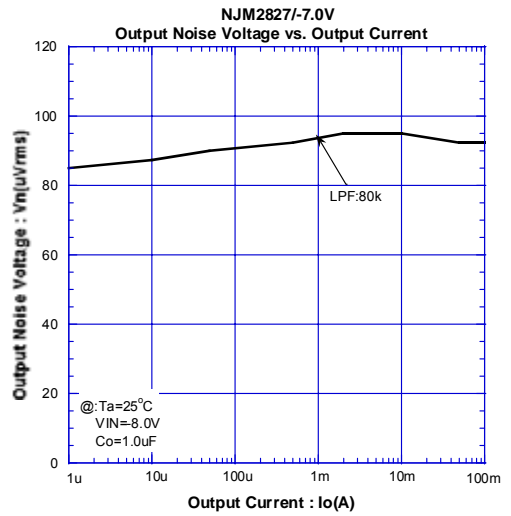
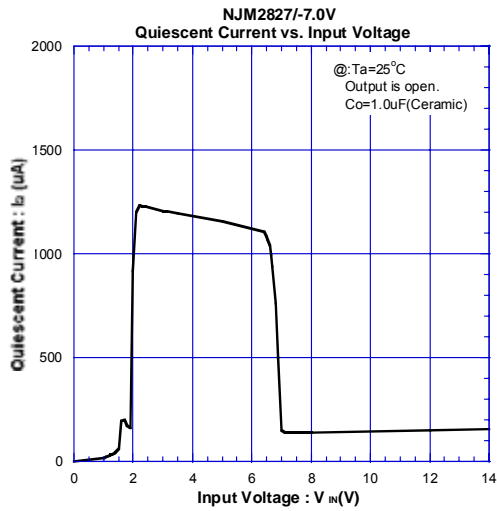

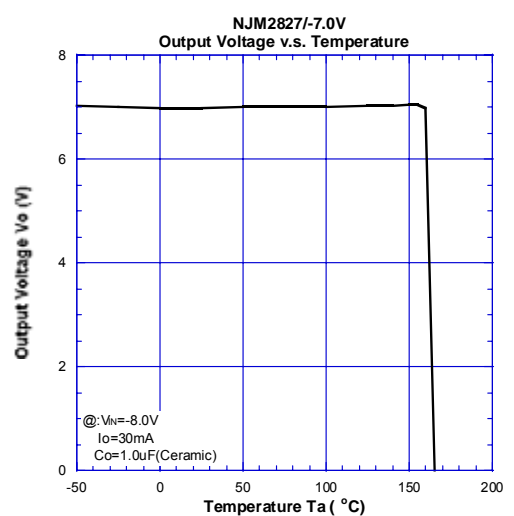
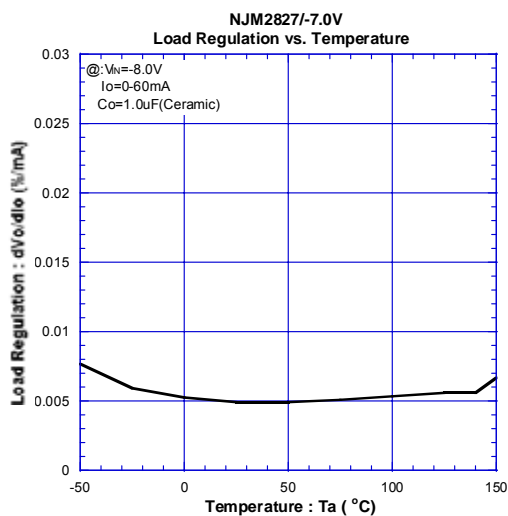
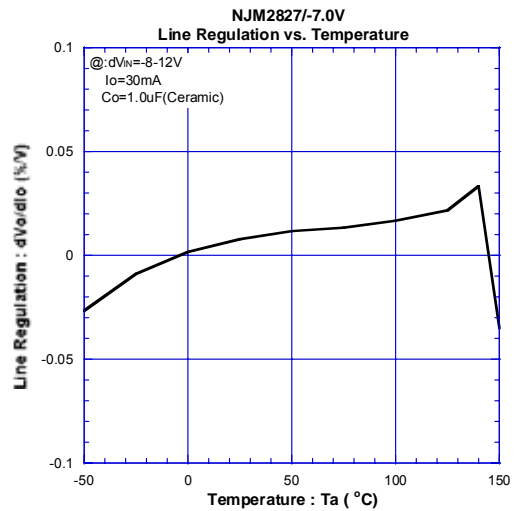
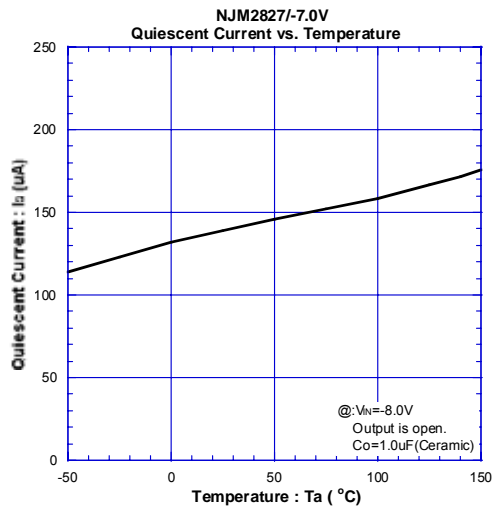
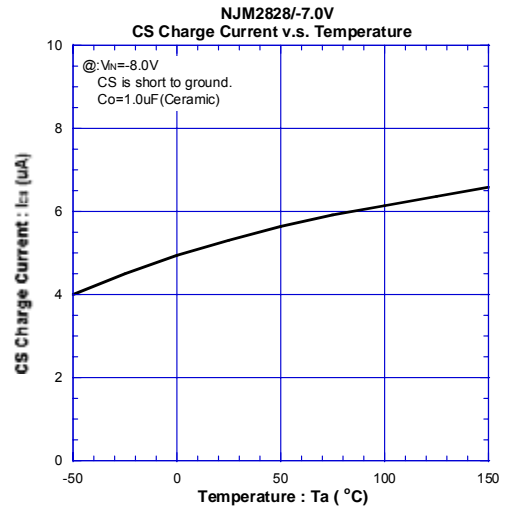
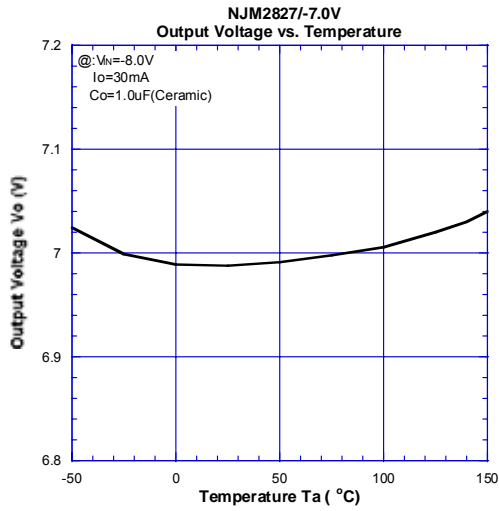

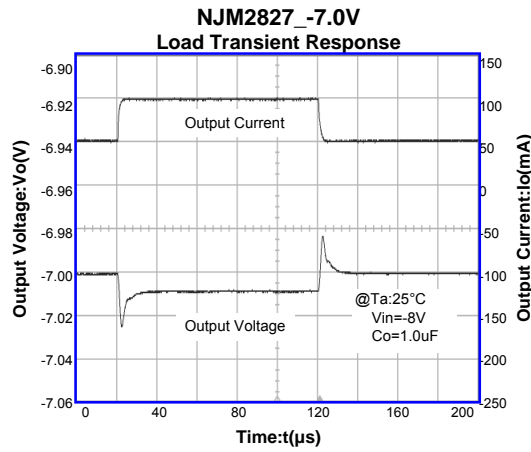
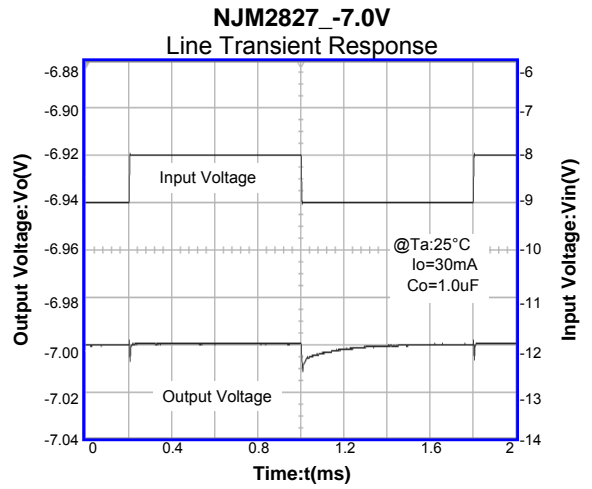
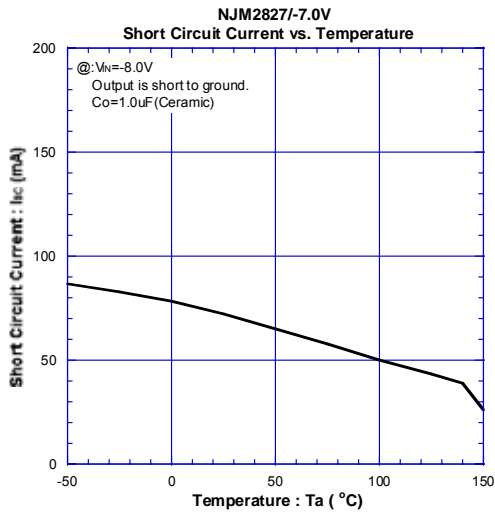

[CAUTION]
The specifications on this databook are only given for information, without any guarantee as regards either mistakes or omissions. The application circuits in this databook are described only to show representative usages of the product and not intended for the guarantee or permission of any right including the industrial rights.