

DS2155DK/DS2156DK T1/E1/J1 Single-Chip Transceiver Design Kit Daughter Cards

www.maxim-ic.com

GENERAL DESCRIPTION

The DS2155/DS2156 design kits are evaluation boards for the DS2155 and DS2156. The DS2155/DS2156 design kits are intended to be used as daughter cards with either the DK2000 or the DK101 motherboards. The boards are complete with a single-chip transceiver (SCT), transformers, termination resistors, configuration switches, line protection circuitry, network connectors, and an interface to the motherboard.

ORDERING INFORMATION

PART	DESCRIPTION
DS2155DK	DS2155 Design Kit Daughter Card
DS2156DK	DS2156 Design Kit Daughter Card

FEATURES

- Expedites New Designs by Eliminating First-Pass Prototyping
- Interfaces Directly to the DK101 or DK2000 Motherboards
- Demonstrates Key Functions of the DS2156 and DS2155
- High-Level Software Provides Visual Access to Registers
- Software-Controlled (Register Mapped) Configuration Switches to Facilitate Clock and Signal Routing
- BNC Connections for 75Ω E1
- Bantam and RJ48 Connectors for 120Ω E1 and 100Ω T1
- Multitap Transformer to Facilitate True Impedance Matching for 75Ω and 120Ω/100Ω Paths
- Network Interface Protection for Overvoltage and Overcurrent Events
- UTOPIA II Bus Connection for MPC8260 (DS2156 Only)
- UTOPIA II Prototype Connectors (DS2156 Only)
- Test Points and Prototype Area Available for Further Customization

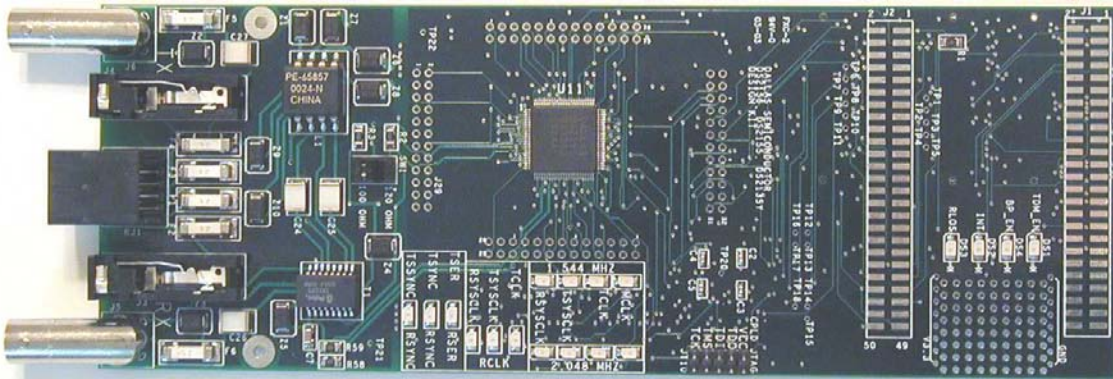

TABLE OF CONTENTS

COMPONENT LIST	3
BASIC OPERATION	4
HARDWARE CONFIGURATION	4
QUICK SETUP (DEMO MODE)	4
QUICK SETUP (REGISTER VIEW)	4
SAMPLE UTOPIA II CONFIGURATION (DS2156 ONLY)	5
REGISTER MAP	5
CPLD REGISTER MAP	6
DS2155/DS2156 INFORMATION	8
DS2155DK/DS2156DK INFORMATION	8
TECHNICAL SUPPORT	8
SCHEMATICS	8

LIST OF TABLES

Table 1. Daughter Card Address Map	5
Table 2. CPLD Register Map	6

COMPONENT LIST

DESIGNATION	QTY	DESCRIPTION	SUPPLIER	PART
C1–C5, C8–C12, C15–C19, C21, C22, C29–C34	23	0.1 μ F 10%, 16V ceramic capacitors (0603)	Digi-Key	311-1088-1-ND
C7, C36	2	1 μ F 10%, 16V ceramic capacitors (1206)	Digi-Key	PCC1882CT-ND
C13, C14	2	0.1 μ F 10%, 16V ceramic capacitors (0805)	Digi-Key	311-1142-1-ND
C23	1	0.1 μ F 10%, 25V ceramic capacitor (1206)	Digi-Key	PCC1883CT-ND
C24–C27	4	0.22 μ F, 50V ceramic capacitors	Digi-Key	UNK
C35	1	10 μ F 20%, 16V tantalum capacitor (B case)	Digi-Key	PCS3106CT-ND
DS1, DS4–DS18	16	LED, green, SMD	Digi-Key	P501CT-ND
DS2, DS3	2	LED, red, SMD	Digi-Key	P500CT-ND
F1–F6	6	250V, 1.25A fuse, SMT	Teccor Electronics	F1250T
J1, J2	2	Male 0.1, SMD, 50-pin, dual-row vertical	Samtec	TSM-125-01-T-DV
J3, J4	2	Bantam connectors	SWK	RTT34B02
J5, J6	2	Connector BNC RA 5-pin	Kruvand	UCBJR220
J7–J9	3	Socket, SMD, 50-pin, dual-row vertical	Samtec	TFM-125-02-S-D-LC
JT10	1	Connector, 10-pin, dual-row vertical	Digi-Key	S2012-05-ND
L1	1	Choke, dual 4-line 24 μ H, 8-pin SO	Pulse Engineering	PE-65857
R1, R14, R21	3	51.1 Ω 1%, 1/8W resistors (1206)	Digi-Key	P51.1FCT-ND
R2, R3, R58, R59	4	0 Ω 5%, 1/8W resistors (1206)	Digi-Key	P0.0ETR-ND
R4, R5, R60	3	51.1 Ω 1%, 1/10W resistors (0805)	Digi-Key	P51.1CCT-ND
R6, R9, R10, R13, R15–R19, R22, R23, R25–R29, R32, R37, R38, R44, R47–R49, R61	24	10k Ω 1%, 1/10W resistors (0805)	Digi-Key	P10.0KCCT-ND
R7, R8, R11, R12, R30, R31, R35, R36, R39–R43, R45, R50–R53	18	330 Ω 0.1%, 1/10W MF resistors (0805)	Digi-Key	P330ZCT-ND
R24	1	1.0k Ω 1%, 1/10W resistor (0805)	Digi-Key	P1.00KCCT-ND
R33, R34	2	NOPOP	—	NOPOP
R46	1	4.7k Ω 1%, 1/8W resistor (0805)	Digi-Key	9C08052A4701FK HFT
R54, R55	2	61.9 Ω 1%, 1/8W resistors (1206)	Digi-Key	P61.9FCT-ND
R56, R57	2	49.9 Ω 1%, 1/8W resistors (1206)	Digi-Key	P49.9FCT-ND
RJ1	1	RJ48 connector	Molex	43223
SW1	1	Switch DPDT slide 6-pin TH	Avnet	SSA22
T1	1	XFMR 16-pin SMT	Pulse Engineering	TX1099
U11	1	T1/E1/J1 XCVR 100-pin QFP, 0°C to +70°C	Dallas Semiconductor	DS2156L
U1–U4, U6	5	BBUS switch 10-bit CMOS, 150-mil, 24-pin SO	IDT	IDTQS3R861Q
U5	1	144-pin macrocell CPLD	Avnet	XC95144XL- 10TQ100C
U7–U10	4	Quad bus switch, 150-mil, 16-pin SO	IDT	IDTQS3125Q
Z1, Z6–Z8	4	160V, 500A Sidactor	Teccor Electronics	P1800SCMC
Z2, Z3	2	58V, 500A Sidactor	Teccor Electronics	P0640SCMC
Z4, Z5	2	6V, 50A Sidactor	Teccor Electronics	P0080SAMC
Z9, Z10	2	25V, 500A Sidactor	Teccor Electronics	P0300SCMC

BASIC OPERATION

This design kit relies upon several supporting files, which can be downloaded from our website at www.maxim-ic.com/DS2155DK.

Hardware Configuration

Using the DK101 processor board:

- Connect the daughter card to the DK101 processor board.
- Supply 3.3V to the banana-plug receptacles marked GND and VCC_3.3V. (The external 5V connector and the TIM 5V supply headers are unused.)
- All processor board DIP switch settings should be in the ON position with exception for the flash programming switch, which should be OFF.
- From the Programs menu launch the host application named ChipView.exe. Run the ChipView application. If the default installation options were used, click the Start button on the Windows toolbar and select Programs→ChipView→ChipView.

Using the DK2000 processor board:

- Connect the daughter card to the DK2000 processor board.
- Connect J1 to the power supply that is delivered with the kit. Alternately, a PC power supply can be connected to connector J2.
- From the Programs menu launch the host application named ChipView.exe. Run the ChipView application. If the default installation options were used, click the Start button on the Windows toolbar and select Programs→ChipView→ChipView.

General:

- Upon power-up the RLOS LED is lit, as well as the MCLK-2.048MHz and TCLK-2.048MHz LEDs.
- Due to the dual winding transformer, only the 120Ω line build-out configuration setting is needed to cover 75Ω E1 and 120Ω E1.

Quick Setup (Demo Mode)

- The PC loads the program, offering a choice among Demo Mode, Register View, and Terminal Mode. Select Demo Mode.
- The program requests a configuration file, then select between the displayed files. (DS2155_E1_DSNCOM_DRV.R.cfg or DS2155_T1_DSNCOM_DRV.R.cfg).
- The Demo Mode screen appears. Upon external loopback, the LOS and OOF indicators extinguish.

Quick Setup (Register View)

- The PC loads the program, offering a choice among Demo Mode, Register View, and Terminal Mode. Select Register View.
- The program requests a definition file, then select DS2155.def.
- The Register View screen appears, showing the register names, acronyms, and values.
- Predefined register settings for several functions are available as initialization files.
 - INI files are loaded by selecting the menu File→Reg Ini File→Load Ini File.
 - Load the INI file DS2155_T1_BERT_ESF.ini.
 - After loading the INI file the following may be observed:
 - The RLOS LED extinguishes upon external loopback.
 - The DS2155/DS2156 begins transmitting a Daly pattern. When external loopback is applied, the BERT bit-count registers BBC1–3 and BEC1–3 may be updated by clearing and setting BC1.LC and clicking the Read All button.

Miscellaneous:

- Clock frequencies and certain pin bias levels are provided by a register-mapped CPLD, which is on the DS2155/DS2156 daughter card.
- The definition file for this CPLD is named DS215x_35x_CPLD_V2.def. See the [CPLD Register Map](#) section for definitions.
- All files referenced above are available for download at www.maxim-ic.com/DS2155DK.

Sample UTOPIA II Configuration (DS2156 Only)

The following register settings configure the DS2156 daughter card for UTOPIA II, single CLAV, 8-bit mode on PHY port 0. UTOPIA II bus connection is provided by header J1 (Tx) and header J2 (Rx).

After configuring the following registers toggle the MSTREG.URST bit to reset the UTOPIA II core.

UTOPIA II Setup, Register Settings for daughter card CPLD

NAME	VALUE	NAME	VALUE
SWITCH 1	0x0F	SWITCH 4	0x0F
SWITCH 2	0x03	LEVELS	0x07
SWITCH 3	0x0F		

UTOPIA II Setup, Register Settings for DS2156 E1 Configuration

NAME	VALUE	NAME	VALUE
MSTREG	0x02	LBCR	0x00
E1RCR1	0x68	TAF	0x9B
E1RCR2	0x00	TNAF	0xC0
E1TCR1	0x15	LIC1	0x11
E1TCR2	0x00	LIC2	0x90
CCR1	0x00	LIC3	0x00
CCR4	0x00	LIC4	0x00
IOCR1	0x00		
IOCR2	0x00		

UTOPIA II Setup, Register Settings for DS2156 UTOPIA II Configuration

NAME	VALUE	NAME	VALUE
U_TCFR	0x01	U_RCR2	0x0
U_TCR1	0x05	U_TIUPB	0x0
U_TCR2	0x00	PCPR	0x22
U_RCFR	0x01	PCDR1, 2, 3, 4	0x0
U_RCR1	0x01		

REGISTER MAP

The DK101 daughter card address space begins at 0x81000000.

The DK2000 daughter card address space begins at:

- 0x30000000 for slot 0
- 0x40000000 for slot 1
- 0x50000000 for slot 2
- 0x60000000 for slot 3

All offsets given in [Table 1](#) are relative to the beginning of the daughter card address space.

Table 1. Daughter Card Address Map

OFFSET	DEVICE	DESCRIPTION
0X0000 to 0X0015	CPLD	Board identification and clock/signal routing
0X1000 to 0X10ff	Single-Chip Transceiver	Board is populated with one of the following: DS2156, DS2155, DS21352, or DS21354. Please see data sheet for details.

Registers in the CPLD can be easily modified using the ChipView.exe, a host-based user interface software along with the definition file named *DS215x_35x_CPLD_V2.def*. Definition files for the SCT are named *DS2155.def*, *DS21352.def*, or *DS21354.def*, depending on the board population option.

CPLD Register Map

Table 2. CPLD Register Map

OFFSET	NAME	TYPE	DESCRIPTION
0X0000	BID	Read-Only	Board ID
0X0002	XBIDH	Read-Only	High-Nibble Extended Board ID
0X0003	XBIDM	Read-Only	Middle-Nibble Extended Board ID
0X0004	XBIDL	Read-Only	Low-Nibble Extended Board ID
0X0005	BREV	Read-Only	Board FAB Revision
0X0006	AREV	Read-Only	Board Assembly Revision
0X0007	PREV	Read-Only	PLD Revision
0X0011	SWITCH1	Read-Write	Pin to 1.544MHz
0X0012	SWITCH2	Read-Write	Pin to 2.048MHz
0X0013	SWITCH3	Read-Write	Pin-to-Pin Connect
0X0014	SWITCH4	Read-Write	Pin-to-Pin Connect
0X0015	LEVELS	Read-Write	Set Level On Pin 1 = 3.3V

ID Registers

OFFSET	NAME	TYPE	VALUE	DESCRIPTION
0X0000	BID	Read-Only	0xD	Board ID
0X0002	XBIDH	Read-Only	0x0	High-Nibble Extended Board ID
0X0003	XBIDM	Read-Only	0x0	Middle-Nibble Extended Board ID
0X0004	XBIDL	Read-Only	0x5	Low-Nibble Extended Board ID
0X0005	BREV	Read-Only	Displays current FAB revision	Board FAB Revision
0X0006	AREV	Read-Only	Displays current assembly revision	Board Assembly Revision
0X0007	PREV	Read-Only	Displays current PLD firmware revision	PLD Revision

Control Registers

The control registers are used primarily to control several banks of FET switches that route clocks and backplane signals. Please note that certain register settings cause line contention, e.g., setting SWITCH1.4 and SWITCH2.4 both to 0 would drive MCLK with both 1.544MHz and 2.048MHz.

SWITCH1: PIN TO 1.544MHz (OFFSET = 0x0011) INITIAL VALUE = 0xF

(MSB)

(LSB)

—	—	—	—	MCLK	TCLK	RSYSCLK	TSYSCLK
---	---	---	---	------	------	---------	---------

NAME	POSITION	FUNCTION
MCLK	SWITCH1.3	0 = Connect MCLK to the 1.544MHz clock 1 = Open Switch 1.4
TCLK	SWITCH1.2	0 = Connect TCLK to the 1.544MHz clock 1 = Open Switch 1.3
RSYSCLK	SWITCH1.1	0 = Connect RSYSCLK to the 1.544MHz clock 1 = Open Switch 1.2
TSYSCLK	SWITCH1.0	0 = Connect TSYSCLK to the 1.544MHz clock 1 = Open Switch 1.1

SWITCH2: PIN TO 2.048MHz (Offset = 0X0012) INITIAL VALUE = 0x3**(MSB)****(LSB)**

—	—	—	—	MCLK	TCLK	RSYSCLK	TSYSCLK
---	---	---	---	------	------	---------	---------

NAME	POSITION	FUNCTION
MCLK	SWITCH2.3	0 = Connect MCLK to the 2.048MHz clock 1 = Open Switch 2.4
TCLK	SWITCH2.2	0 = Connect TCLK to the 2.048MHz clock 1 = Open Switch 2.3
RSYSCLK	SWITCH2.1	0 = Connect RSYSCLK to the 2.048MHz clock 1 = Open Switch 2.2
TSYSCLK	SWITCH2.0	0 = Connect TSYSCLK to the 2.048MHz clock 1 = Open Switch 2.1

SWITCH3: PIN-TO-PIN CONNECT (Offset = 0X0013) INITIAL VALUE = 0xF**(MSB)****(LSB)**

—	—	—	—	TSS_RS	TCL_RC	RSY_RC	TSY_RC
---	---	---	---	--------	--------	--------	--------

NAME	POSITION	FUNCTION
TSS_RS	SWITCH3.3	0 = Connect TSSYNC to RSYNC 1 = Open Switch 3.4
TCL_RC	SWITCH3.2	0 = Connect TCLK to RCLK 1 = Open Switch 3.3
RSY_RC	SWITCH3.1	0 = Connect RSYSCLK to RCLK 1 = Open Switch 3.2
TSY_RC	SWITCH3.0	0 = Connect TSYSCLK to RCLK 1 = Open Switch 3.1

SWITCH4: PIN-TO-PIN CONNECT (Offset = 0X0014) INITIAL VALUE = 0x3**(MSB)****(LSB)**

—	—	—	—	UTCLK_2048	UT_CLK_2048	RSER_TSER	RSYNC_TSYNC
---	---	---	---	------------	-------------	-----------	-------------

NAME	POSITION	FUNCTION
URCLK_2048	SWITCH4.3	0 = Connect UR_CLK (TSSYNC) to 2.048MHz 1 = Open Switch 4.4
UTCLK_2048	SWITCH4.2	0 = Connect UT_CLK (TCHCLK) to 2.048MHz 1 = Open Switch 4.3
RSER_TSER	SWITCH4.1	0 = Connect RER to TSER 1 = Open Switch 4.2
RSYNC_TSYNC	SWITCH4.0	0 = Connect RSYNC to TSYNC 1 = Open Switch 4.1

LEVELS: SET LEVEL ON PIN (Offset = 0X0015) INITIAL VALUE = 0x6

(MSB)

(LSB)

—	—	—	—	—	BP_EN	PPCTDM_EN	TUSEL
---	---	---	---	---	-------	-----------	-------

NAME	POSITION	FUNCTION
—	LEVELS1.3	—
BP_EN	LEVELS1.2	0 = Enable IDT switches that connect the UTOPIA bus to daughter card header
PPCTDM_EN	LEVELS1.1	0 = Enable IDT switches that connect the TDM bus to the daughter card header
TUSEL	LEVELS1.0	0 = Set DS2156.TUSEL to enable TDM backplane 1 = Set DS2156.TUSEL to enable UTOPIA backplane

Note: When the UTOPIA backplane is enabled (LEVELS.TUSEL = 1) there is a possibility for contention between the UTOPIA bus master and TSYSClk, TSER, and RSER. To avoid this, the following switches should be opened when the UTOPIA backplane is enabled: SWITCH1.0, SWITCH2.0, SWITCH3.0, and SWITCH4.1

DS2155/DS2156 INFORMATION

For more information about the DS2155 and DS2156, please consult the DS2155 and DS2156 data sheets available on our website at www.maxim-ic.com/DS2155 and www.maxim-ic.com/DS2156. Software downloads are also available for this design kit.

DS2155DK/DS2156DK INFORMATION

For more information about the DS2155DK and DS2156DK, including software downloads, please consult the DS2155DK/DS2156DK data sheet available on our website at www.maxim-ic.com/DS2155DK.

TECHNICAL SUPPORT

For additional technical support, please e-mail your questions to telecom.support@dalsemi.com.

SCHEMATICS

The DS2155DK/DS2156DK schematics are featured in the following 13 pages.

DOCUMENT REVISION HISTORY

REVISION DATE	DESCRIPTION
032503	Initial DS2155DK/DS2156DK data sheet release.
060303	Updated the <i>Title, General Description, Features, and Basic Operation</i> sections; "TIM" replaced with "daughter card."
012705	Updated schematics (removed component values for Fuse and Sidactor; see <i>Component List</i>).
110106	Updated schematics.

DS2156, DS2155, DS2135Y DESIGN KIT

CONTENTS

1. COVER PAGE
2. SCT POPULATION OPTION (DS2155, DS2156, DS21352 OR DS21354)
3. TX AND RX ANALOG PATHS
4. TIM ADDRESS AND DATA BUS
5. CPLD ADDRESS DATA CONNECTIONS, BIAS LEVELS FOR SCT
6. UTOPIA: TIM HEADER AND BUS SWITCHES
7. TESTPOINTS FOR UTOPIA 2
8. UTOPIA: NETLIST ASSOCIATIONS
9. SWITCHING FOR CLOCKS AND TDM
10. SUPPLY DECOUPLING
11. SCT TESTPOINTS
12. NETLIST CROSS-REFERENCE
13. PART CROSS-REFERENCE

TITLE:	DS2156DK02A0	DATE:	10/04/02
ENGINEER:	STEVE SCULLY	PAGE:	1 / 13

DS2156L

U11

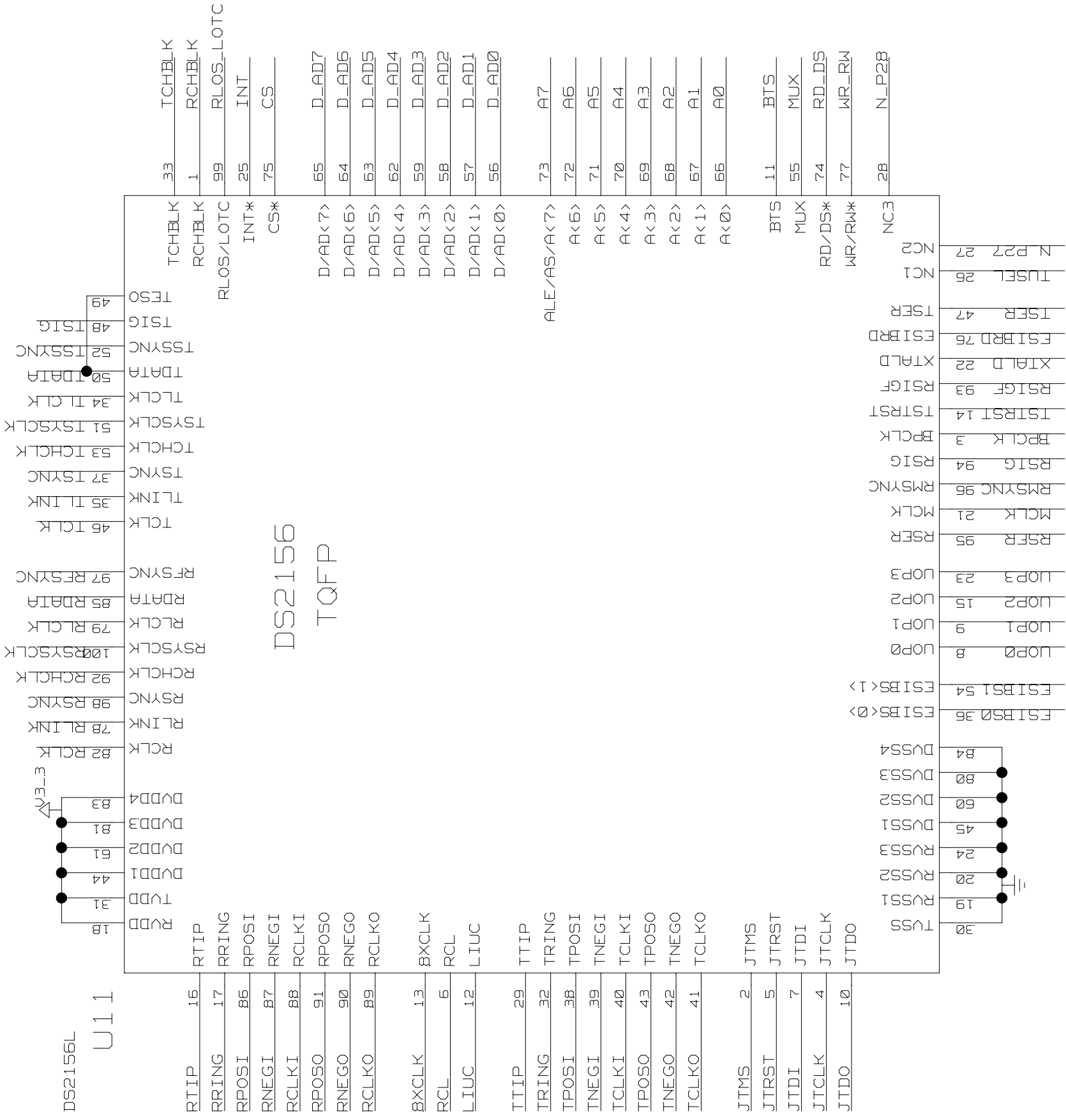

DS2156
TQFP

TITLE:	DS2156DK02A0	DATE:	10/04/02
ENGINEER:	STEVE SCULLY	PAGE:	2 / 13

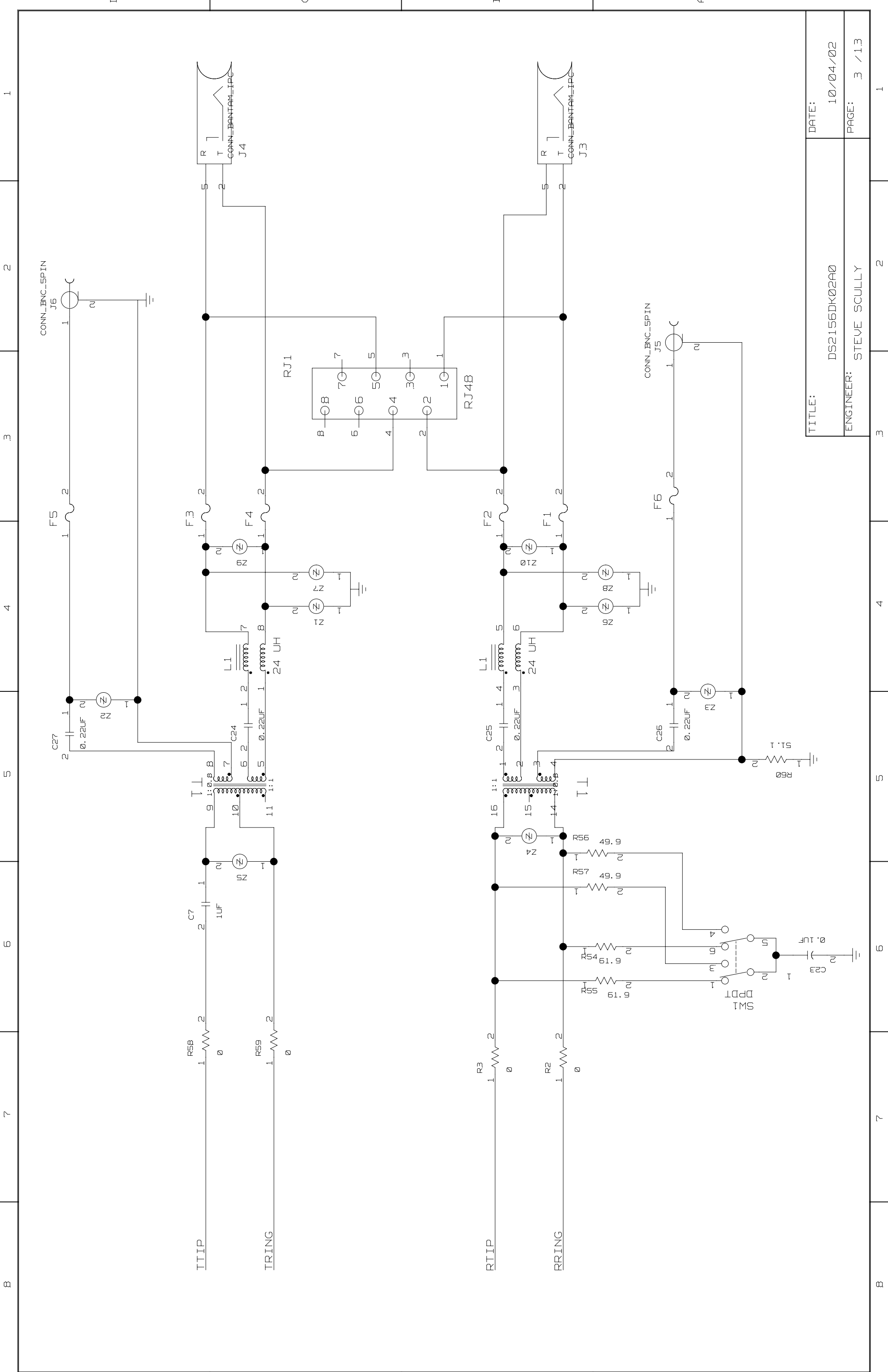

TITLE:	DS2156DK02A0
ENGINEER:	STEVE SCULLY
DATE:	10/04/02
PAGE:	3 / 13

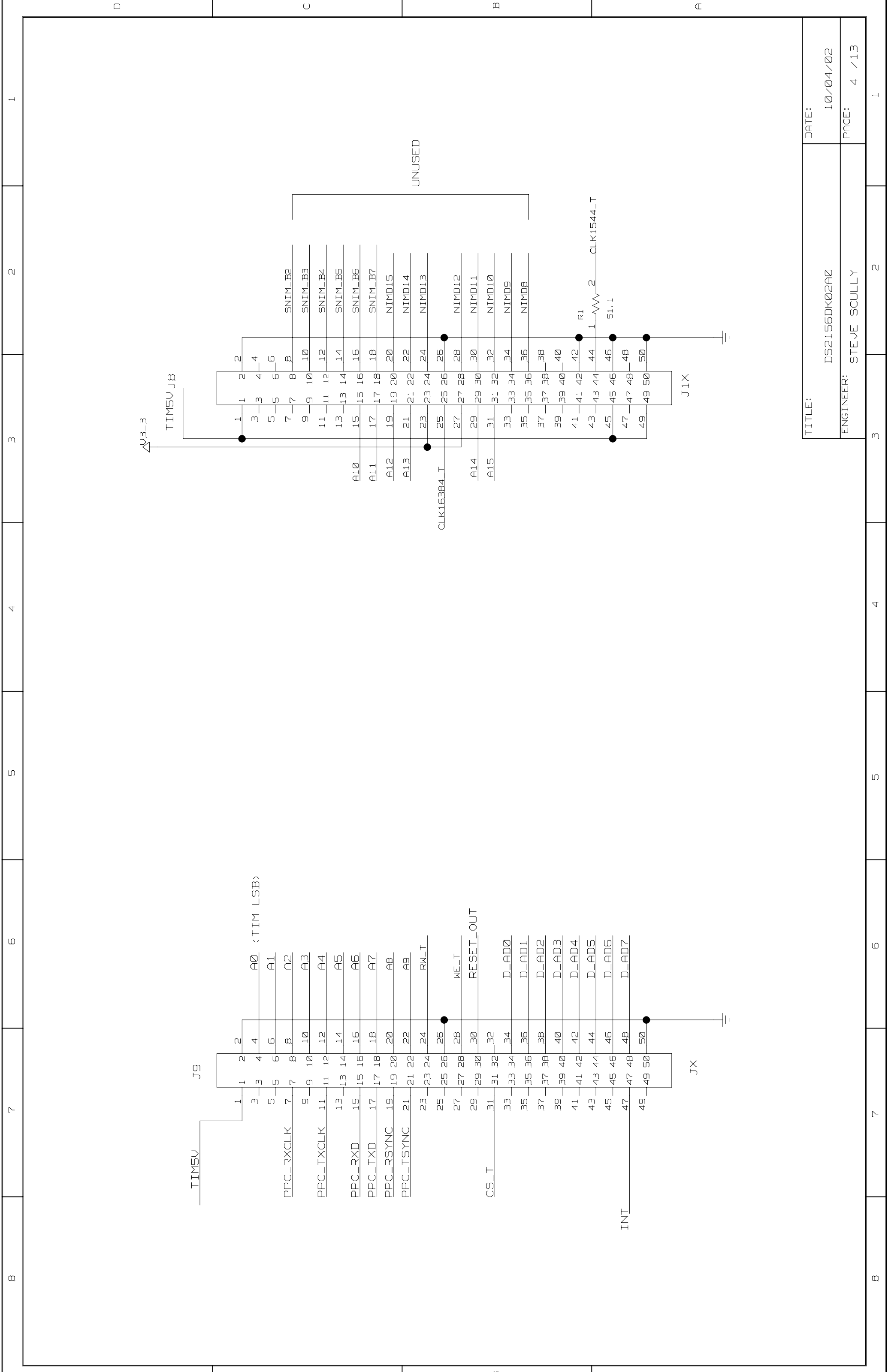

TITLE:	DS2156DK02A0	DATE:	10/04/02
ENGINEER:	STEVE SCULLY	PAGE:	4 / 13

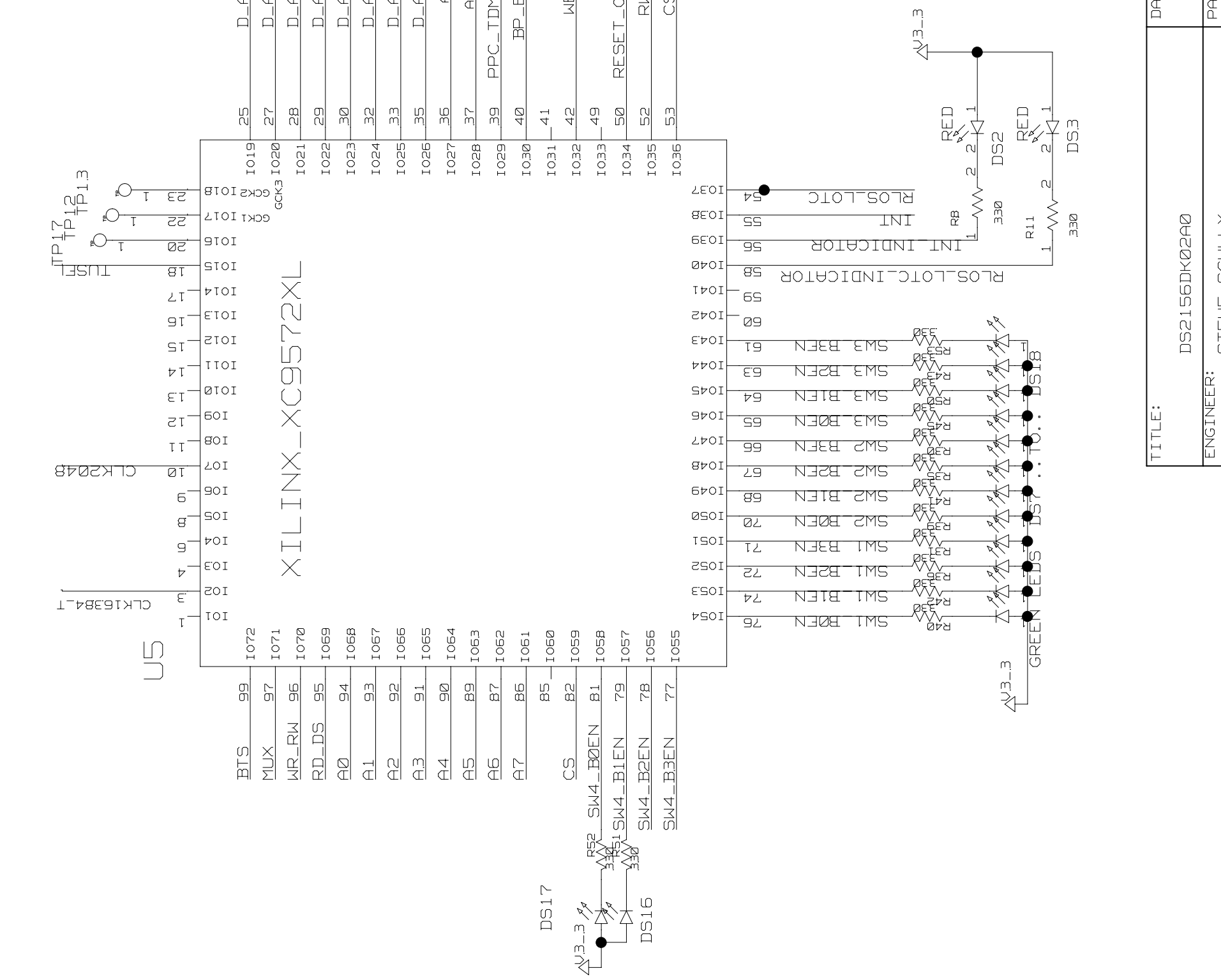
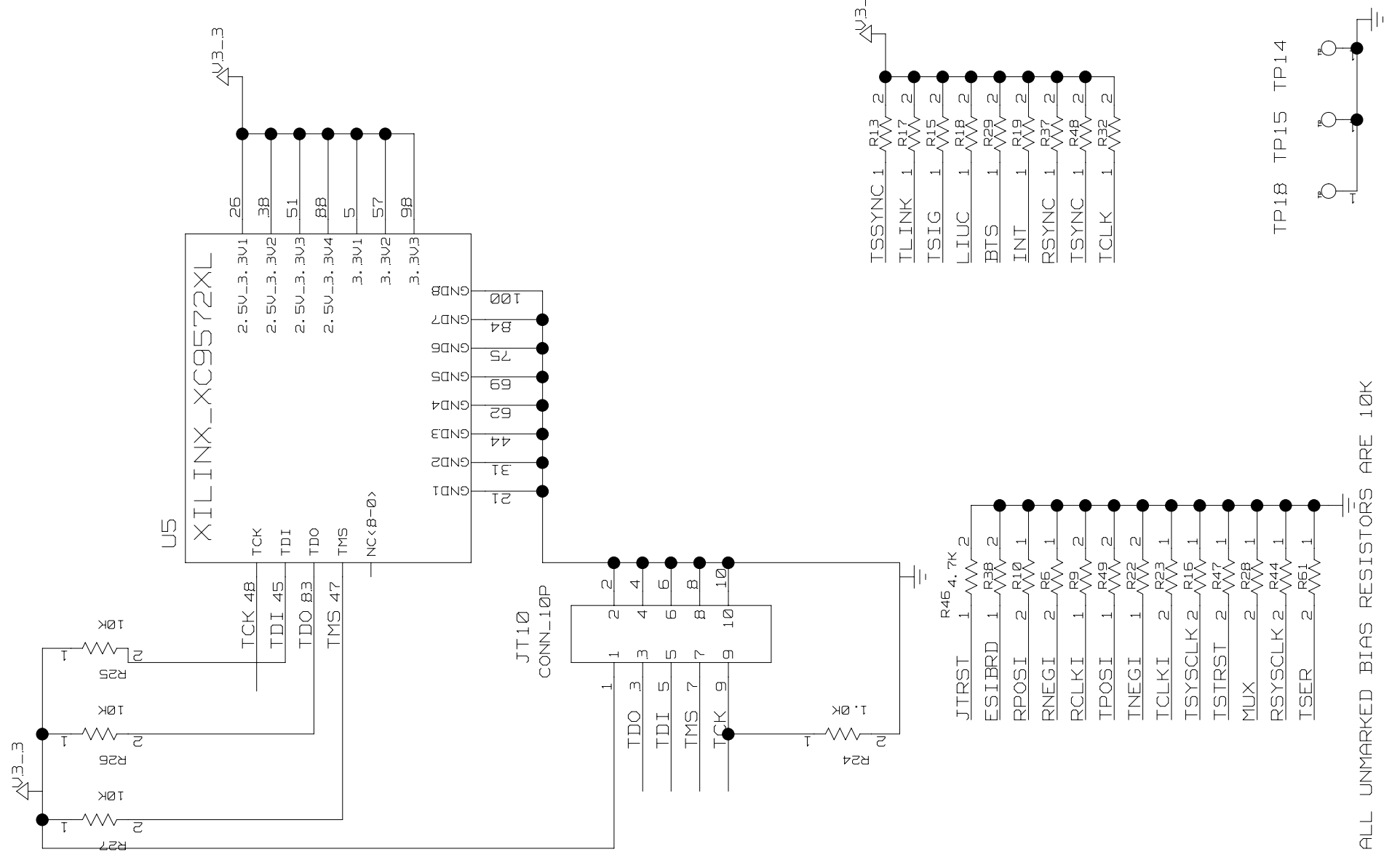

1	2	3	4	5	6	7	8
---	---	---	---	---	---	---	---

TITLE: DS2156DK02A0
 ENGINEER: STEVE SCULLY
 DATE: 10/04/02
 PAGE: 5 / 13

ALL UNMARKED BIAS RESISTORS ARE 10K

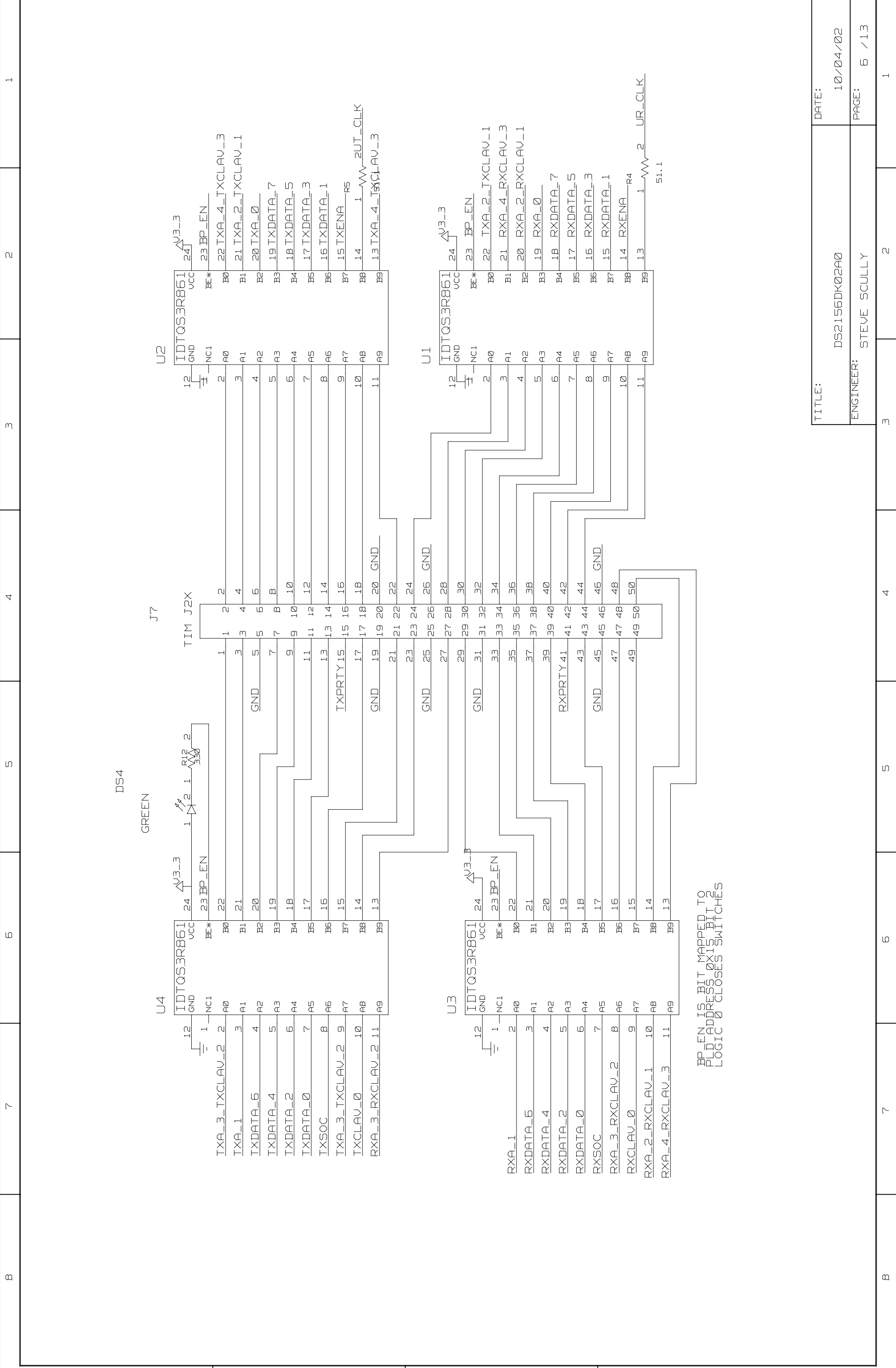

BP_EN IS BIT MAPPED TO
PLD ADDRESS 0X15 BIT 2
LOGIC 0 CLOSES SWITCHES

J1

CONN_50P1

TXDATA_0	1	2	TXDATA_1
TXDATA_2	3	4	TXDATA_3
GND	5	6	TXDATA_4
TXDATA_5	7	8	TXDATA_6
TXDATA_7	9	10	GND
	11	12	
	13	14	
	15	16	
	17	18	
	19	20	GND
	21	22	TXSOC
TXADDR0	23	24	TXADDR1
GND	25	26	TXADDR2
TXADDR3	27	28	TXADDR4
TXCLAV0	29	30	GND
	31	32	
	33	34	TXENABLE
	35	36	R14 2 LUT_CLK
	37	38	
	39	40	
	41	42	
	43	44	
	45	46	
	47	48	
	49	50	

ADTECH TX

J2

CONN_50P1

RXDATA_0	1	2	RXDATA_1
RXDATA_2	3	4	RXDATA_3
GND	5	6	RXDATA_4
RXDATA_5	7	8	RXDATA_6
RXDATA_7	9	10	GND
	11	12	
	13	14	
	15	16	
	17	18	
	19	20	GND
	21	22	RXSOC
	23	24	
	25	26	
	27	28	
	29	30	
	31	32	
	33	34	
	35	36	
RXADDR0	37	38	RXADDR1
RXADDR2	39	40	GND
RXADDR3	41	42	RXADDR4
RXCLAV0	43	44	
GND	45	46	
	47	48	RXENB
UR_CLK_1	49	50	
	51		

ADTECH RX

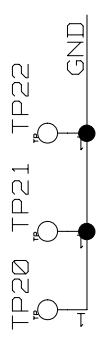
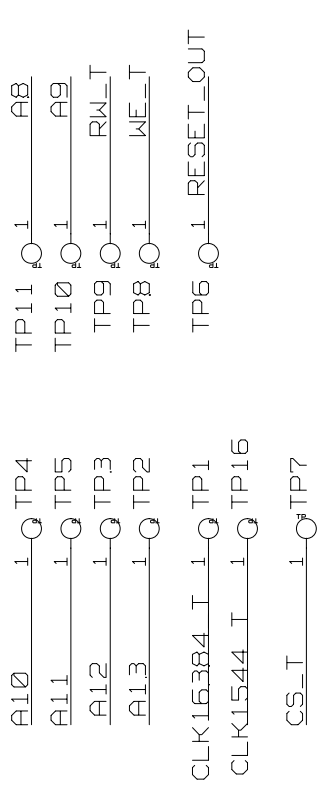

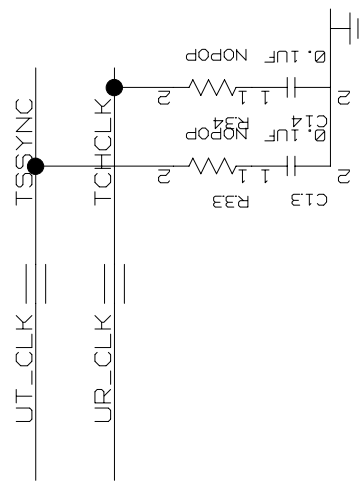
8	7	6	5	4	3	2	1
D	D	C	B	A			
RXADDR0 == RXA_0 == UR_ADDR0 == RCHCLK == RXADDR1 == RXA_1 == UR_ADDR1 == RSIGF == RXADDR2 == RXA_2_RXCLAV_1 == UR_ADDR2 == RSIG == RXADDR3 == RXA_3_RXCLAV_2 == UR_ADDR3 == RMSYNC == RXADDR4 == RXA_4_RXCLAV_3 == UR_ADDR4 == RFSYNC == RXCLAV0 == RXCLAV_0 == UR_CLAV == RSER == RXDATA_0 == RXDATA_0 == UR_DATA0 == RLINK == RXDATA_1 == RXDATA_1 == UR_DATA1 == RLCLK == RXDATA_2 == RXDATA_2 == UR_DATA2 == RPOSI == RXDATA_3 == RXDATA_3 == UR_DATA3 == RNEGI == RXDATA_4 == RXDATA_4 == UR_DATA4 == RCLKI == RXDATA_5 == RXDATA_5 == UR_DATA5 == RCLKO == RXDATA_6 == RXDATA_6 == UR_DATA6 == RNEGO == RXDATA_7 == RXDATA_7 == UR_DATA7 == RPOSO ==	RXENB == RXENA == UR_ENB == BPCLK == RXSOC == RXSOC == UR_SOC == RCHBLK == TXADDR0 == TXA_0 == UT_ADDR0 == UOP3 == TXADDR1 == TXA_1 == UT_ADDR1 == TCHBLK == TXADDR2 == TXA_2_TXCLAV_1 == UT_ADDR2 == TLCLK == TXADDR3 == TXA_3_TXCLAV_2 == UT_ADDR3 == TLINK == TXADDR4 == TXA_4_TXCLAV_3 == UT_ADDR4 == TPOSI == TXCLAV0 == UT_CLAV == TXCLAV_0 == LIUC == TXDATA_0 == TXDATA_0 == UT_DATA0 == TNEGI == TXDATA_1 == TXDATA_1 == UT_DATA1 == TCLKI == TXDATA_2 == TXDATA_2 == UT_DATA2 == TCLKO == TXDATA_3 == TXDATA_3 == UT_DATA3 == TNEGO == TXDATA_4 == TXDATA_4 == UT_DATA4 == TPOSO == TXDATA_5 == TXDATA_5 == UT_DATA5 == TSER ==	TXDATA_6 == TXDATA_6 == UT_DATA6 == TSIG == TXDATA_7 == TXDATA_7 == UT_DATA7 == TSYSCLK == TXENABLE == TXENA == UT_ENB == UOP1 == TXSOC == TXSOC == UT_SOC == UOP0 ==	UT_CLK == TSSYNC UR_CLK == TCHCLK 				
D	C	B	A				
TITLE:	DS2156DK02A0	DATE:	10/04/02	ENGINEER:	STEVE SCULLY	PAGE:	8 / 13
8	7	6	5	4	3	2	1

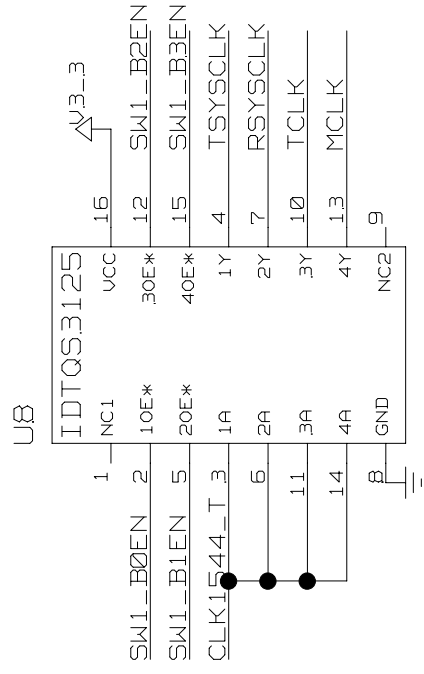

SWITCH 1 IS MEMORY MAPPED TO PLD REGISTER 0X11 LOGIC 0 CLOSES SWITCH LOGIC 1 OPENS SWITCH

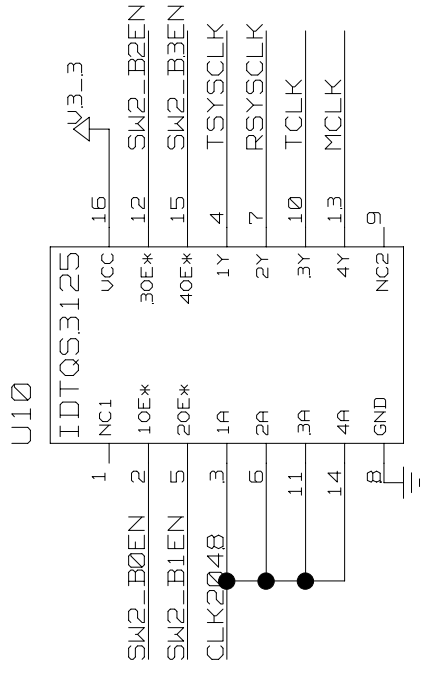

SWITCH 2 IS MEMORY MAPPED TO PLD REGISTER 0X12 LOGIC 0 CLOSES SWITCH LOGIC 1 OPENS SWITCH

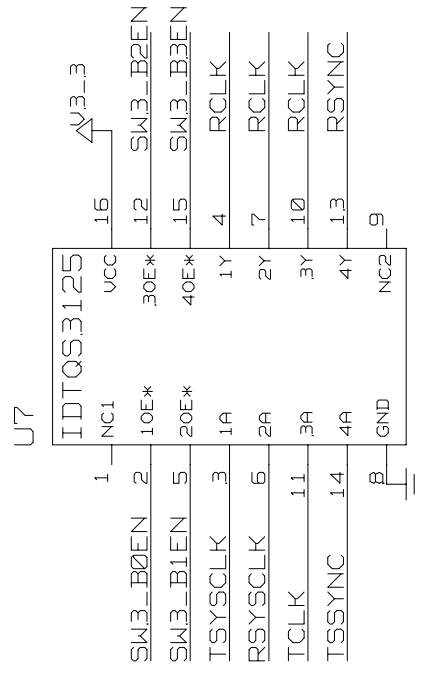

SWITCH 3 IS MEMORY MAPPED TO PLD REGISTER 0X13 LOGIC 0 CLOSES SWITCH LOGIC 1 OPENS SWITCH

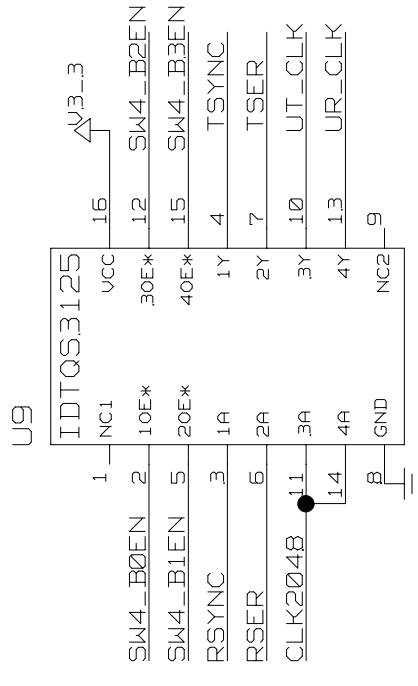

SWITCH 4 IS MEMORY MAPPED TO PLD REGISTER 0X14 LOGIC 0 CLOSES SWITCH LOGIC 1 OPENS SWITCH

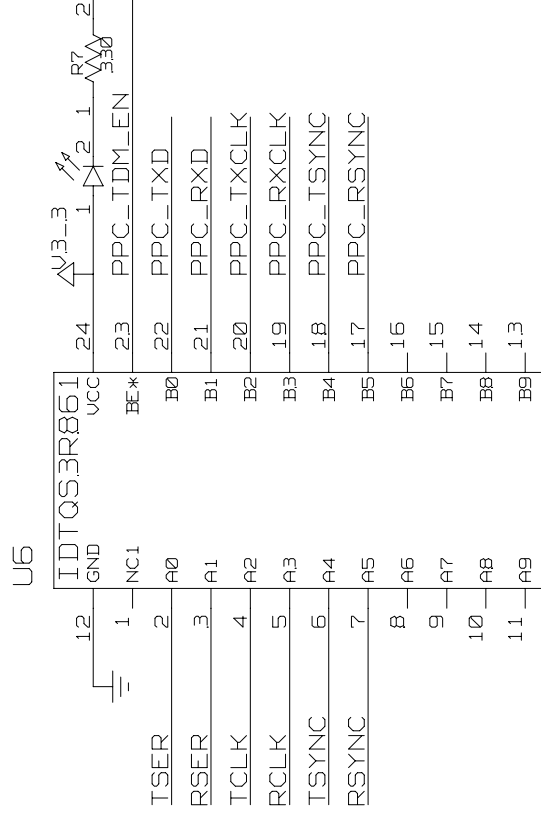

PPC_TDM_EN IS BIT MAPPED TO PLD ADDRESS 0X15 BIT 1 LOGIC 0 CLOSES SWITCHES

TITLE:

DS2156DK02A0

DATE:

10/04/02

ENGINEER:

STEVE SCULLY

PAGE:

9 / 13

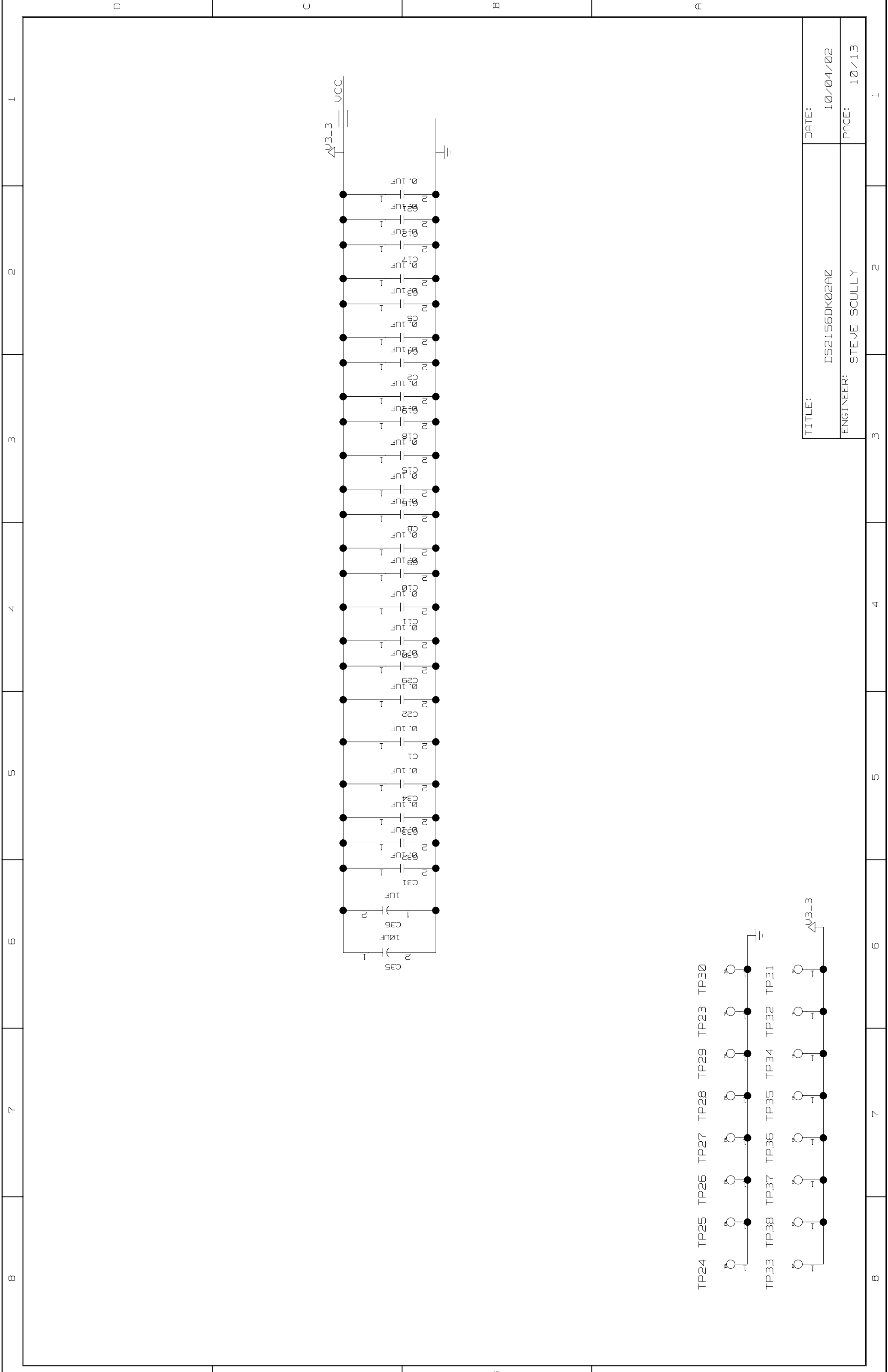

TITLE:	DS2156DK02A0
DATE:	10/04/02
ENGINEER:	STEVE SCULLY
PAGE:	10/13

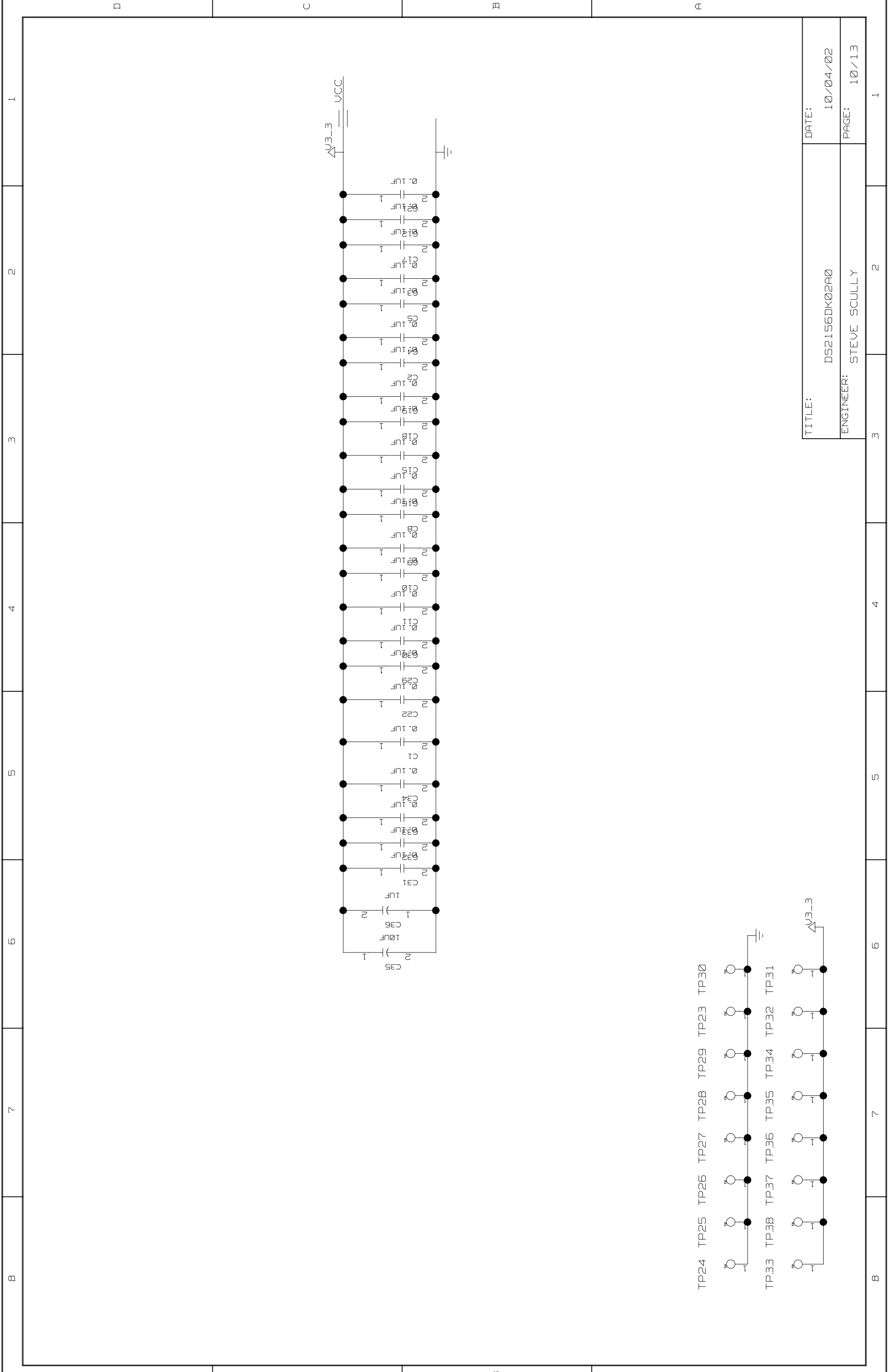
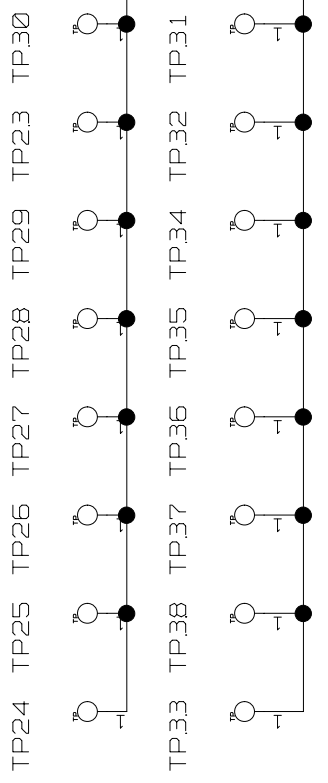

TITLE:	DS2156DK02A0
DATE:	10/04/02
ENGINEER:	STEVE SCULLY
PAGE:	10/13

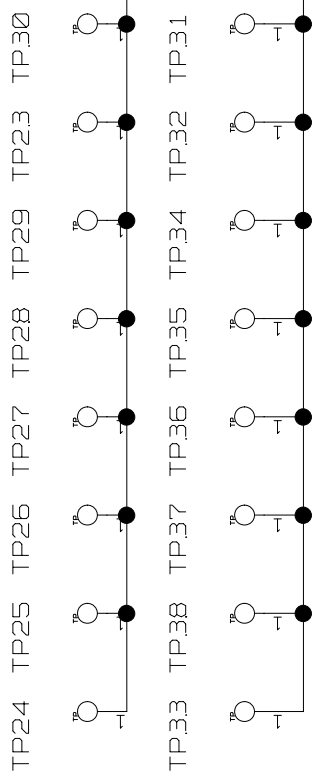

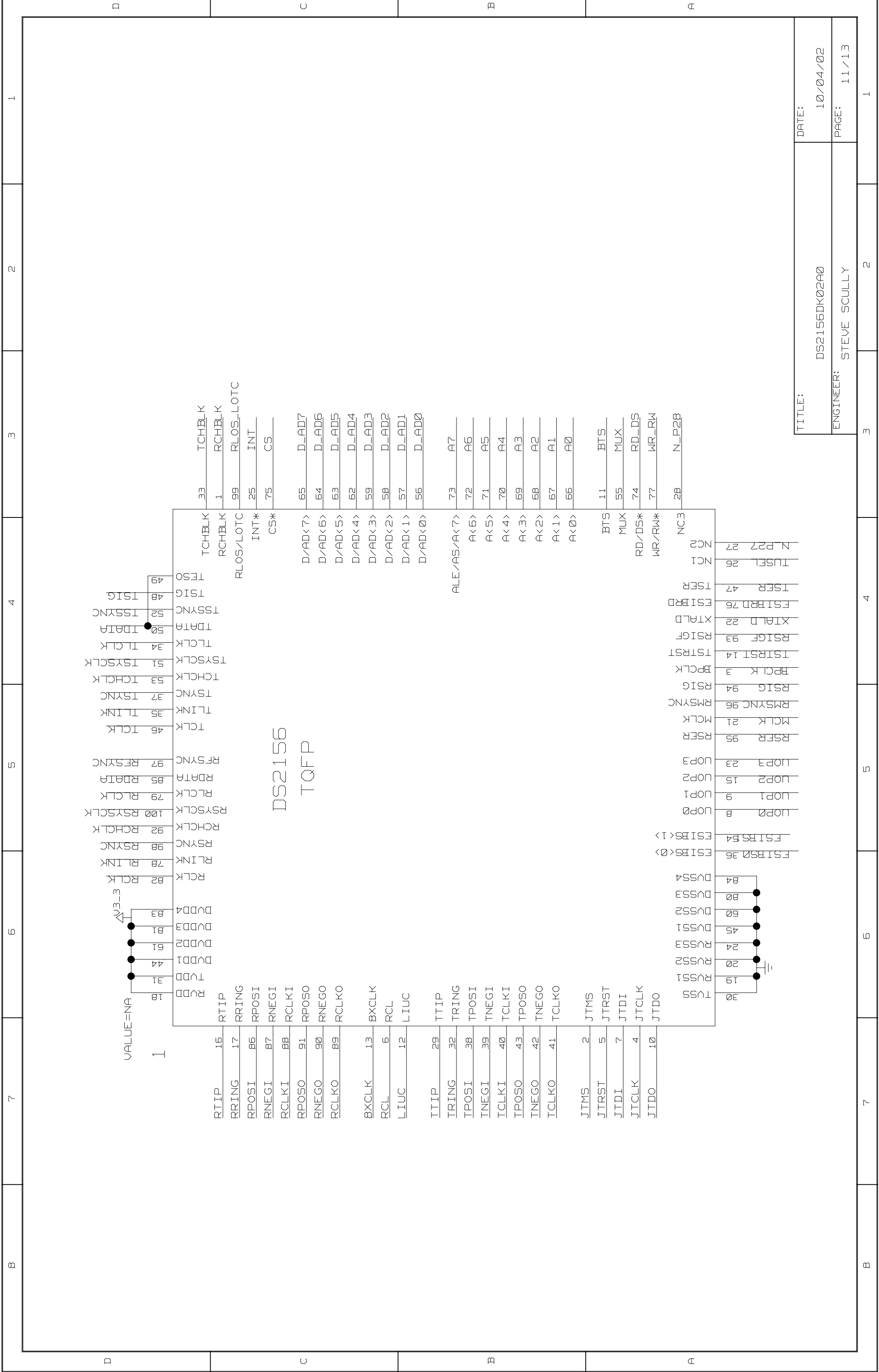
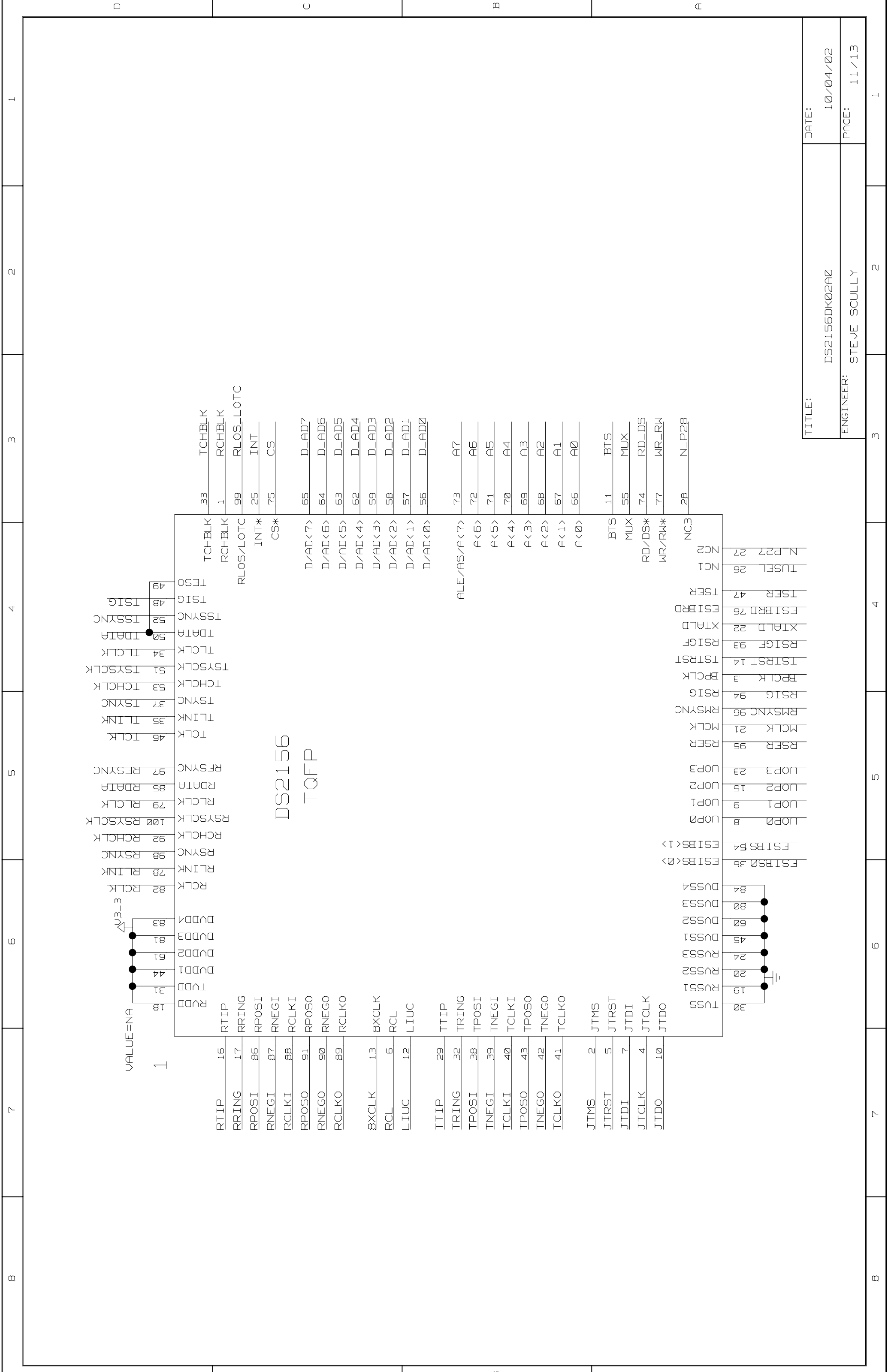

Pin	Signal	Pin	Signal
1	RCHBLK	51	TSYSCLK
2	JTMS	52	TSSYNC
3	JTRST	53	TCHCLK
4	JTDI	54	TSER
5	JTCLK	55	MUX
6	RCL	56	D/AD<0>
7	TNEGI	57	D/AD<1>
8	UOP0	58	D/AD<2>
9	UOP1	59	D/AD<3>
10	JTDO	60	TNEGO
11	BTS	61	DYDD2
12	LIUC	62	D/AD<4>
13	8XCLK	63	D/AD<5>
14	TSTRST	64	D/AD<6>
15	UOP2	65	D/AD<7>
16	RTIP	66	A<0>
17	RRING	67	A<1>
18	RCD	68	A<2>
19	RY51	69	A<3>
20	RY52	70	A<4>
21	MCLK	71	A<5>
22	XTALD	72	A<6>
23	UOP3	73	A<7>
24	RY53	74	RD/DS*
25	DY51	75	CS*
26	NC1	76	ESIBRD
27	NC2	77	WR/RW*
28	N_P28	78	RLINK
29	TTIP	79	RLCLK
30	TS5	80	DY53
31	TYDD	81	DY51
32	TRING	82	RCLK
33	TCHBLK	83	DYDD4
34	TLCLK	84	DY54
35	TLINK	85	RDATA
36	ESIBS<0>	86	RPOSI
37	RSIG	87	RNEGI
38	ESIBS<1>	88	RCLKI
39	TPOSI	89	RCLKO
40	TCLKI	90	RNEGO
41	TCLKO	91	RPOSO
42	TNEGO	92	RCHCLK
43	TPOSO	93	RSIGF
44	DYDD1	94	RSIG
45	DY51	95	RSE
46	TCLK	96	RMSYNC
47	TSIG	97	RFSYNC
48	TSIG	98	RSYNC
49	TSO	99	RLOS_LOTC

*** Part Cross-Reference for the entire design ***

1 DS2156_TQFP 11D7
 C1 CAP 10B5
 C2 CAP 10B3
 C3 CAP 10B2
 C4 CAP 10B2
 C5 CAP 10B2
 C7 CAP 3D6
 C8 CAP 10B4
 C9 CAP 10B4
 C10 CAP 10B4
 C11 CAP 10B4
 C12 CAP 10B2
 C13 CAP 8A1
 C14 CAP 8A1
 C15 CAP 10B3
 C16 CAP 10B3
 C17 CAP 10B2
 C18 CAP 10B3
 C19 CAP 10B3
 C21 CAP 10B2
 C22 CAP 10B5
 C24 CAP 3A6
 C25 CAP 3C5
 C26 CAP 3B5
 C27 CAP 3A5
 C29 CAP 3D5
 C30 CAP 10B4
 C31 CAP 10B6
 C32 CAP 10B5
 C33 CAP 10B5
 C34 CAP 10B5
 C35 CAP 10B5
 C36 CAP 10B6
 DS1 LED 9B4
 DS2 LED 5A2
 DS3 LED 5A2
 DS4 LED 6D5
 DS5 LED 5A3
 DS7 LED 5A3
 DS8 LED 5A4
 DS9 LED 5A4
 DS10 LED 5A3
 DS11 LED 5A4
 DS12 LED 5A3
 DS13 LED 5A3
 DS14 LED 5A3
 DS15 LED 5A3
 DS16 LED 5B5
 DS17 LED 5B5
 DS18 LED 5A3
 F1 FUSE 3B4
 F2 FUSE 3B4
 F3 FUSE 3D4
 F4 FUSE 3C4
 F5 FUSE 3D4
 F6 FUSE 3A3
 J1 CONN_50P1 7D5
 J2 CONN_50P1 7D7
 J3 CONN_BANTAM_IPC 3B1
 J4 CONN_BANTAM_IPC 3C1
 J5 CONN_BNC_SPIN 3A3
 J6 CONN_BNC_SPIN 3D2
 J7 CONN_50P2 6D4
 J8 CONN_50P2 4D3
 J9 CONN_50P2 4D7
 JT10 CONN_10P 5C8
 L1 CHOKE_DUAL-T1 3B4 3C4
 R1 RES1 4B2
 R2 RES 3B7
 R3 RES 3B7
 R4 RES 6A2
 R5 RES 6C2
 R6 RES1 5A7

R7 RES 9B4
 R8 RES1 5A2
 R9 RES1 5A7
 R10 RES1 5A7
 R11 RES1 5A2
 R12 RES 6D5
 R13 RES1 5B6
 R14 RES1 7B4
 R15 RES1 5B6
 R16 RES1 5A7
 R17 RES1 5B6
 R18 RES1 5A6
 R19 RES1 5A6
 R21 RES1 7A8
 R22 RES1 5A7
 R23 RES1 5A7
 R24 RES1 5B8
 R25 RES1 5D7
 R26 RES1 5D8
 R27 RES1 5D8
 R28 RES1 5A7
 R29 RES1 5A6
 R30 RES 5A3
 R31 RES 5A3
 R32 RES1 5A6
 R33 RES1 8A1
 R34 RES1 8A1
 R35 RES 5A3
 R36 RES 5A3
 R37 RES1 5A6
 R38 RES 5A7
 R39 RES 5A3
 R40 RES 5A4
 R41 RES 5A3
 R42 RES 5A4
 R43 RES 5A3
 R44 RES1 5A7
 R45 RES 5A3
 R46 RES1 5B7
 R47 RES1 5A7
 R48 RES1 5A6
 R49 RES1 5A7
 R50 RES 5A3
 R51 RES 5B4
 R52 RES 5B4
 R53 RES 5A3
 R54 RES1 3B6
 R55 RES1 3B6
 R56 RES 3B5
 R57 RES 3B6
 R58 RES 3D7
 R59 RES 3C7
 R60 RES 3A5
 R61 RES1 5A7
 RJ1 RJ4B_CON 3C3
 SW1 SWITCH_DPDT_SLIDE_6P 3A6
 T1 XFMR_2IN_4OUT_U 3B5 3D5
 TP1 TSTPNT_SNG 7B2
 TP2 TSTPNT_SNG 7B2
 TP3 TSTPNT_SNG 7B2
 TP4 TSTPNT_SNG 7C2
 TP5 TSTPNT_SNG 7C2
 TP6 TSTPNT_SNG 7B2
 TP7 TSTPNT_SNG 7B2
 TP8 TSTPNT_SNG 7B2
 TP9 TSTPNT_SNG 7B2
 TP10 TSTPNT_SNG 7B2
 TP11 TSTPNT_SNG 7B2
 TP12 TSTPNT_SNG 5D2
 TP13 TSTPNT_SNG 5D2
 TP14 TSTPNT_SNG 5A6
 TP15 TSTPNT_SNG 5A6
 TP16 TSTPNT_SNG 7B2
 TP17 TSTPNT_SNG 5D2
 TP18 TSTPNT_SNG 5A6
 TP20 TSTPNT_SNG 7B2
 TP21 TSTPNT_SNG 7B1

TP22 TSTPNT_SNG 7B1
 TP23 TSTPNT_SNG 10A7
 TP24 TSTPNT_SNG 10A8
 TP25 TSTPNT_SNG 10A7
 TP26 TSTPNT_SNG 10A7
 TP27 TSTPNT_SNG 10A7
 TP28 TSTPNT_SNG 10A7
 TP29 TSTPNT_SNG 10A7
 TP30 TSTPNT_SNG 10A7
 TP31 TSTPNT_SNG 10A4
 TP32 TSTPNT_SNG 10A4
 TP33 TSTPNT_SNG 10A5
 TP34 TSTPNT_SNG 10A5
 TP35 TSTPNT_SNG 10A5
 TP36 TSTPNT_SNG 10A5
 TP37 TSTPNT_SNG 10A5
 TP38 TSTPNT_SNG 10A5
 U1 IDT053RB61-U 6B3
 U2 IDT053RB61-U 6D3
 U3 IDT053RB61-U 6B6
 U4 IDT053RB61-U 6D6
 U5 XILINX_XC9572XL 5D4 5D7
 U6 IDT053RB61-U 9B5
 U7 IDT053125-U 9D3
 U8 IDT053125-U 9D7
 U9 IDT053125-U 9B3
 U10 IDT053125-U 9B7
 U11 DS2156_TQFP 2D7
 Z1 SIDACTOR_2 3C4
 Z2 SIDACTOR_2 3D5
 Z3 SIDACTOR_2 3A5
 Z4 SIDACTOR_2 3B5
 Z5 SIDACTOR_2 3C6
 Z6 SIDACTOR_2 3A4
 Z7 SIDACTOR_2 3C4
 Z8 SIDACTOR_2 3A4
 Z9 SIDACTOR_2 3C4
 Z10 SIDACTOR_2 3B4