

Miniature Glass Passivated Single-Phase Bridge Rectifiers

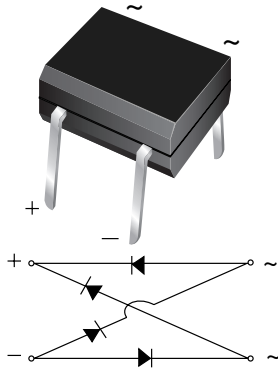

Case Style MBM

| PRIMARY CHARACTERISTICS | |
|-------------------------|---------------------|
| $I_{F(AV)}$ | 0.5 A |
| V_{RRM} | 200 V, 400 V, 600 V |
| I_{FSM} | 30 A |
| I_R | 5 μ A |
| V_F | 1.0 V |
| T_J max. | 150 °C |

FEATURES

- UL recognized, file number E54214
- Ideal for printed circuit boards
- Applicable for automotive insertion
- Middle surge current capability
- Recommended for non-automotive applications
- Solder dip 260 °C, 40 s
- Component in accordance to RoHS 2002/95/EC and WEEE 2002/96/EC



RoHS
COMPLIANT

TYPICAL APPLICATIONS

General purpose use in ac-to-dc bridge full wave rectification for power supply, lighting ballaster, battery charger, home appliances, office equipment, and telecommunication applications.

MECHANICAL DATA

Case: MBM

Epoxy meets UL 94V-0 flammability rating

Terminals: Matte tin plated leads, solderable per J-STD-002 and JESD22-B102

E3 suffix for consumer grade, meets JESD 201 class 1A whisker test

Polarity: As marked on body

| MAXIMUM RATINGS ($T_A = 25\text{ °C}$ unless otherwise noted) | | | | | |
|--|----------------|--------------------|-----|-----|------------------|
| PARAMETER | SYMBOL | B2M | B4M | B6M | UNIT |
| Device marking code | | B2 | B4 | B6 | |
| Maximum repetitive peak reverse voltage | V_{RRM} | 200 | 400 | 600 | V |
| Maximum RMS voltage | V_{RMS} | 140 | 280 | 420 | V |
| Maximum DC blocking voltage | V_{DC} | 200 | 400 | 600 | V |
| Maximum average forward output rectified current (Fig. 1) on glass-epoxy P.C.B. | $I_{F(AV)}$ | 0.5 ⁽¹⁾ | | | A |
| Peak forward surge current 10 ms single half sine-wave superimposed on rated load (JEDEC method) | I_{FSM} | 30 | | | A |
| Rating for fusing ($t < 8.3$ ms) | I^2t | 5.0 | | | A ² s |
| Operating junction and storage temperature range | T_J, T_{STG} | - 55 to + 150 | | | °C |

Note:

(1) On glass epoxy P.C.B. mounted on 0.05 x 0.05" (1.3 x 1.3 mm) pads



| ELECTRICAL CHARACTERISTICS (T _A = 25 °C unless otherwise noted) | | | | | | |
|--|---|----------------|-----|------------|-----|------|
| PARAMETER | TEST CONDITIONS | SYMBOL | B2M | B4M | B6M | UNIT |
| Maximum instantaneous forward voltage drop per diode | 0.5 A | V _F | | 1.0 | | V |
| Maximum DC reverse current at rated DC blocking voltage per diode | T _A = 25 °C T _A = 125 °C | I _R | | 5.0 100 | | μA |
| Typical junction capacitance per diode | 4.0 V, 1 MHz | C _J | | 13 | | pF |

| THERMAL CHARACTERISTICS (T _A = 25 °C unless otherwise noted) | | | | | | |
|---|--------------------------------------|-----|----------|-----|------|--|
| PARAMETER | SYMBOL | B2M | B4M | B6M | UNIT | |
| Typical thermal resistance ⁽¹⁾ | R _{θJA} R _{θJL} | | 90 40 | | °C/W | |

Note:

(1) On glass epoxy P.C.B. mounted on 0.05 x 0.05" (1.3 x 1.3 mm) pads

| ORDERING INFORMATION (Example) | | | | |
|--------------------------------|-----------------|------------------------|---------------|---------------|
| PREFERRED P/N | UNIT WEIGHT (g) | PREFERRED PACKAGE CODE | BASE QUANTITY | DELIVERY MODE |
| B2M-E3/45 | 0.22 | 45 | 100 | Tube |

RATINGS AND CHARACTERISTICS CURVES

(T_A = 25 °C unless otherwise noted)

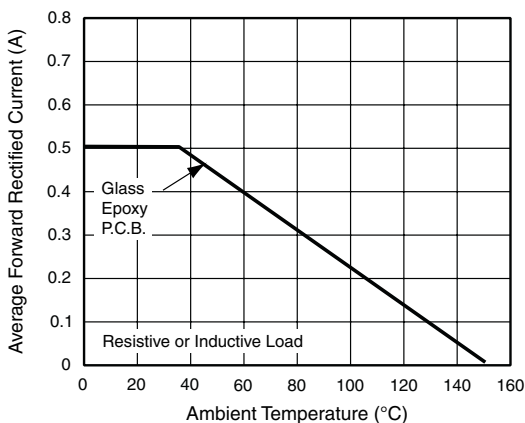

Figure 1. Derating Curve for Output Rectified Current

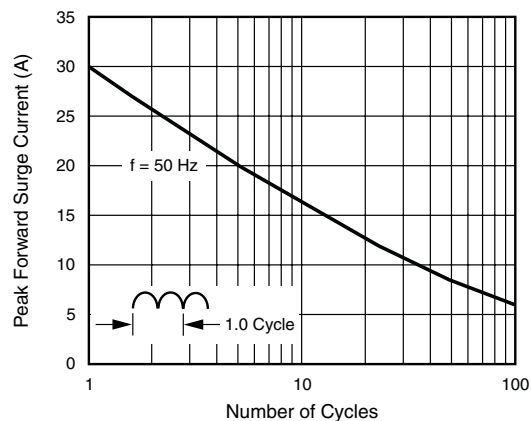

Figure 2. Maximum Non-Repetitive Peak Forward Surge Current Per Diode

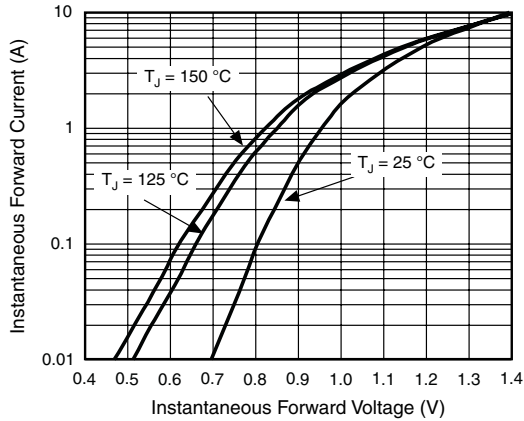

Figure 3. Typical Forward Voltage Characteristics Per Diode

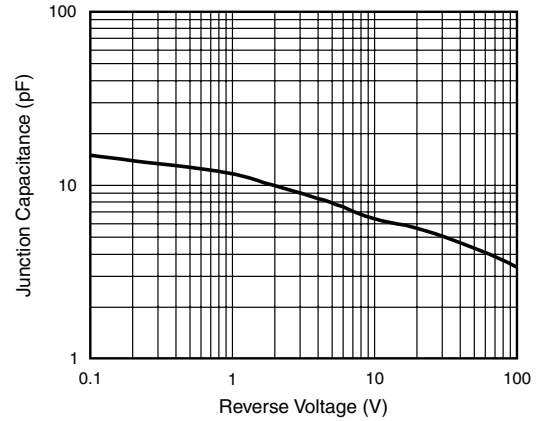

Figure 5. Typical Junction Capacitance Per Diode

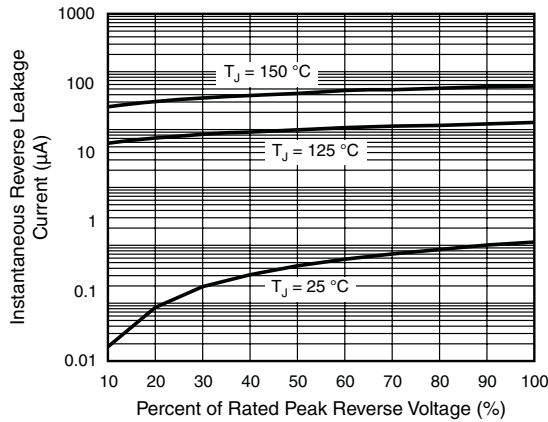
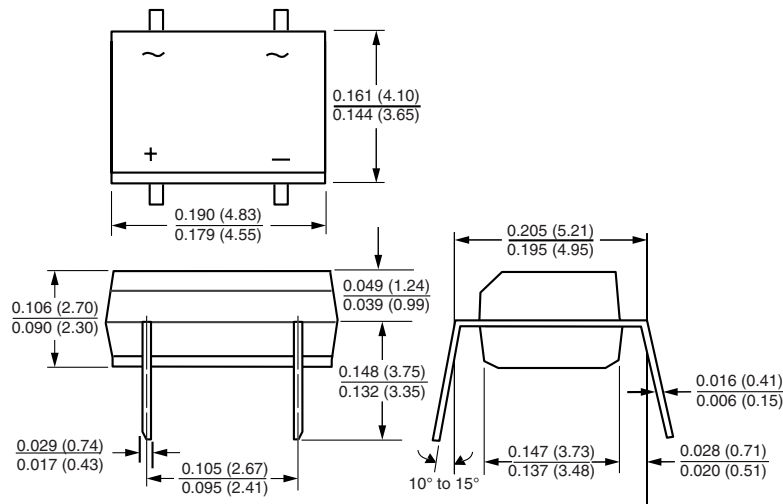

Figure 4. Typical Reverse Leakage Characteristics Per Diode

PACKAGE OUTLINE DIMENSIONS in inches (millimeters)

Case Style MBM





Disclaimer

All product specifications and data are subject to change without notice.

Vishay Intertechnology, Inc., its affiliates, agents, and employees, and all persons acting on its or their behalf (collectively, "Vishay"), disclaim any and all liability for any errors, inaccuracies or incompleteness contained herein or in any other disclosure relating to any product.

Vishay disclaims any and all liability arising out of the use or application of any product described herein or of any information provided herein to the maximum extent permitted by law. The product specifications do not expand or otherwise modify Vishay's terms and conditions of purchase, including but not limited to the warranty expressed therein, which apply to these products.

No license, express or implied, by estoppel or otherwise, to any intellectual property rights is granted by this document or by any conduct of Vishay.

The products shown herein are not designed for use in medical, life-saving, or life-sustaining applications unless otherwise expressly indicated. Customers using or selling Vishay products not expressly indicated for use in such applications do so entirely at their own risk and agree to fully indemnify Vishay for any damages arising or resulting from such use or sale. Please contact authorized Vishay personnel to obtain written terms and conditions regarding products designed for such applications.

Product names and markings noted herein may be trademarks of their respective owners.