



4MHz Dual 400mA Synchronous Buck Regulator with Low Input Voltage and HyperLight Load™

General Description

The MIC23254 is a low-input voltage, high-efficiency 4MHz dual 400mA synchronous buck regulator with HyperLight Load™ mode. HyperLight Load™ provides very-high efficiency at light loads and ultra-fast transient response which is perfectly suited for supplying processor core voltages. An additional benefit of this proprietary architecture is very-low output ripple voltage throughout the entire load range with the use of small output capacitors. MIC23254 operates from an input voltage down to 2.5V for low battery states. The MIC23254 has a tiny 2mm x 2mm Thin MLF® package that saves precious board space by requiring only 6 additional external components to drive both outputs up to 400mA each.

The device is designed for use with a 1µH inductor and a 4.7µF output capacitor that enables a sub-1mm height.

The MIC23254 has a very-low quiescent current of 33µA with both outputs enabled and can achieve over 85% efficiency at 1mA. At higher loads the MIC23254 provides a constant switching frequency around 4MHz while providing peak efficiencies over 90%.

The MIC23254 fixed output voltage option is available in a 10-pin 2mm x 2mm Thin MLF®. The MIC23254 is designed to operate over the junction operating range from -40°C to +125°C.

Data sheets and support documentation can be found on Micrel's web site at: www.micrel.com.

Features

- Low input voltage range: 2.5V to 5.5V
- Dual output current 400mA/400mA
- Up to 94% peak efficiency and 85% efficiency at 1mA
- 33µA dual quiescent current
- 1µH inductor with a 4.7µF capacitor
- 4MHz in PWM operation
- Ultra-fast transient response
- Low voltage output ripple
- 20mVpp in HyperLight Load™ mode
- 3mV output voltage ripple in full PWM mode
- 0.01µA shutdown current
- Fixed output: 10-pin 2mm x 2mm Thin MLF®
- -40°C to +125°C junction temperature range

Applications

- Mobile handsets
- Portable media players
- Portable navigation devices (GPS)
- WiFi/WiMax/WiBro modules
- Digital cameras
- Wireless LAN cards
- USB Powered Devices

Typical Application

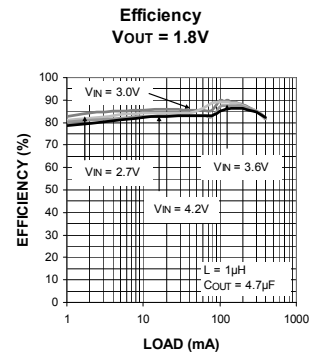
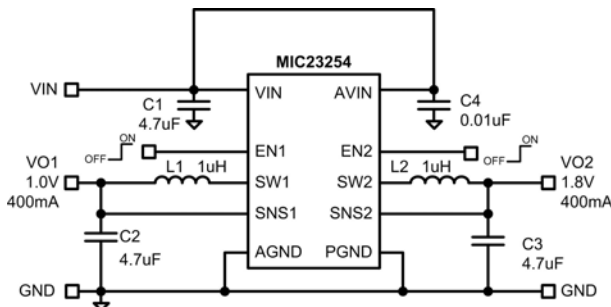

HyperLight Load is a trademark of Micrel, Inc.
MLF and MicroLeadFrame are registered trademarks of Amkor Technology, Inc.

Micrel Inc. • 2180 Fortune Drive • San Jose, CA 95131 • USA • tel +1 (408) 944-0800 • fax + 1 (408) 474-1000 • <http://www.micrel.com>

Ordering Information

Part Number	Marking Code	Nominal Output Voltage 1	Nominal Output Voltage 2	Junction Temperature Range	Package	Lead Finish
MIC23254-GCYMT	GCW	1V	1.8V	-40° to +125°C	10-Pin 2mm x 2mm Thin MLF [®]	Pb-Free

Notes:

1. Thin MLF[®] is GREEN RoHS compliant package. Lead finish is NiPdAu. Mold compound is Halogen Free.

Pin Configuration

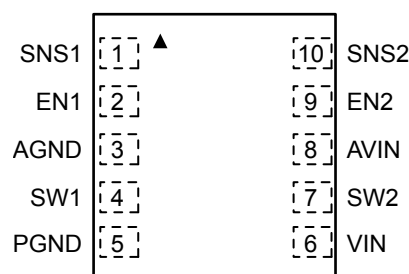

10-Pin 2mm x 2mm Thin MLF[®] (MT) Fixed Output
(Top View)

Pin Description

Pin Number (Fixed)	Pin Name	Pin Function
1	SNS1	Sense 1 (Input): Connect to V_{OUT1} as close to output capacitor as possible to sense output 1 voltage.
2	EN1	Enable 1 (Input): Logic low will shut down output 1. Logic high powers up output 1. Do not leave unconnected.
3	AGND	Analog Ground. Must be connected externally to PGND.
4	SW1	Switch Node 1 (Output): Internal power MOSFET output.
5	PGND	Power Ground.
6	VIN	Supply Voltage (Power Input): Requires close bypass capacitor to PGND.
7	SW2	Switch Node 2 (Output): Internal power MOSFET output.
8	AVIN	Supply Voltage (Power Input): Analog control circuitry. Connect to VIN.
9	EN2	Enable 2 (Input): Logic low will shut down output 2. Logic high powers up output 2. Do not leave unconnected.
10	SNS2	Sense 2 (Input): Connect to V_{OUT2} as close to output capacitor as possible to sense output 2 voltage.

Absolute Maximum Ratings⁽¹⁾

Supply Voltage (V_{IN})	-0.3V to +6V
Output Switch Voltage (V_{SW})	-0.3V to 6V
Sense Input Voltage (V_{SNS1} , V_{SNS2})	-0.3V to V_{IN}
Logic Input Voltage (V_{EN1} , V_{EN2})	-0.3V to V_{IN}
Storage Temperature Range (T_s)	-65°C to +150°C
ESD Rating ⁽³⁾	ESD Sensitive

Operating Ratings⁽²⁾

Supply Voltage (V_{IN})	2.5V to 5.5V
Sense Input Voltage (V_{SNS1} , V_{SNS2})	0V to V_{IN}
Logic Input Voltage (V_{EN1} , V_{EN2})	0V to V_{IN}
Junction Temperature (T_J)	-40°C ≤ T_J ≤ +125°C
Thermal Resistance	
2mm x 2mm Thin MLF-10 (θ_{JA})	70°C/W

Electrical Characteristics⁽⁴⁾

$T_A = 25^\circ\text{C}$ with $V_{IN} = V_{EN1} = V_{EN2} = 3.6\text{V}$; $L = 1\mu\text{H}$; $C_{OUT} = 4.7\mu\text{F}$; $I_{OUT} = 20\text{mA}$; only one channel power is enabled, unless otherwise specified. **Bold** values indicate $-40^\circ\text{C} \leq T_J \leq +125^\circ\text{C}$.

Parameter	Condition	Min.	Typ.	Max.	Units
Under-Voltage Lockout Threshold	(Turn-On)	2.3	2.4	2.485	V
UVLO Hysteresis			60		mV
Quiescent Current	$V_{OUT1,2}$ (Both Enabled), $I_{OUT1,2} = 0\text{mA}$, $V_{SNS1,2} > 1.2 \times V_{OUT1,2}$ Nominal		33	50	μA
Shutdown Current	$V_{EN1,2} = 0\text{V}$; $V_{IN} = 5.5\text{V}$		0.01	4	μA
Output Voltage Accuracy	$V_{IN} = 3.6\text{V}$, $I_{LOAD} = 20\text{mA}$	-2.5		+2.5	%
Current Limit in PWM Mode	$SNS = 0.9 \times V_{OUT\text{NOM}}$	0.410	0.62	1	A
Output Voltage Line Regulation	$V_{IN} = 3.6\text{V}$ to 5.5V , $I_{LOAD} = 20\text{mA}$		0.4		%/V
Output Voltage Load Regulation	$20\text{mA} < I_{LOAD} < 400\text{mA}$, $V_{IN} = 3.6\text{V}$		0.5		%
PWM Switch ON-Resistance	$I_{SW} = 100\text{mA}$ PMOS $I_{SW} = -100\text{mA}$ NMOS		0.6 0.8		Ω
Frequency	$I_{LOAD} = 120\text{mA}$		4		MHz
Soft-Start Time	$V_{OUT} = 90\%$		260		μs
Enable Threshold		0.5	0.9	1.2	V
Enable Input Current			0.1	2	μA
Over-Temperature Shutdown			160		$^\circ\text{C}$
Over-Temperature Shutdown Hysteresis			20		$^\circ\text{C}$

Notes:

- Exceeding the absolute maximum rating may damage the device.
- The device is not guaranteed to function outside its operating rating.
- Devices are ESD sensitive. Handling precautions recommended. Human body model: 1.5k Ω in series with 100pF.
- Specification for packaged product only.

Typical Characteristics

Quiescent Current vs. Input Voltage

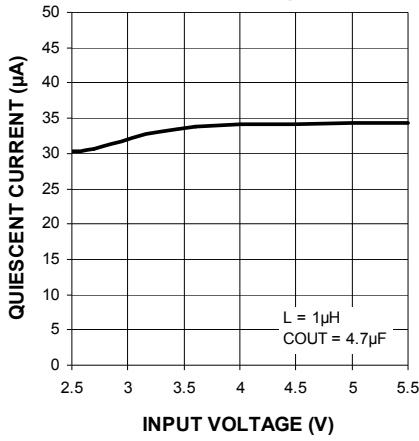

Switching Frequency vs. Output Current

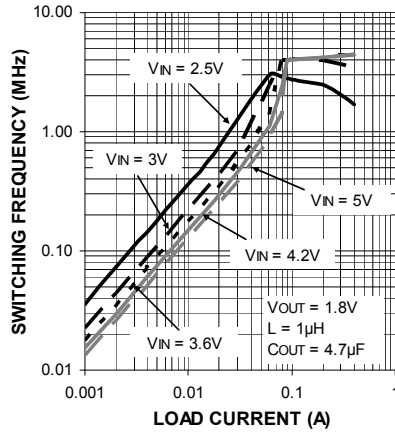

Switching Frequency vs. Output Current

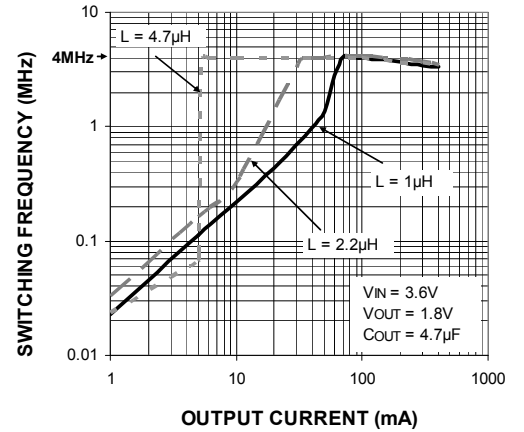

Frequency vs. Temperature

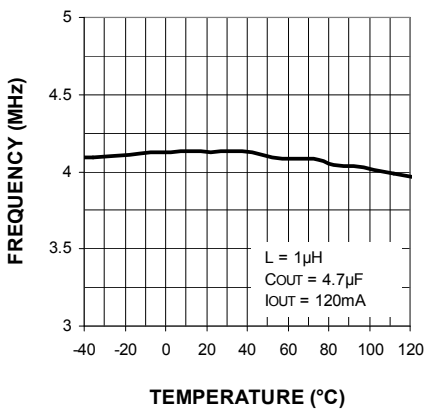

Output Voltage vs. Output Current

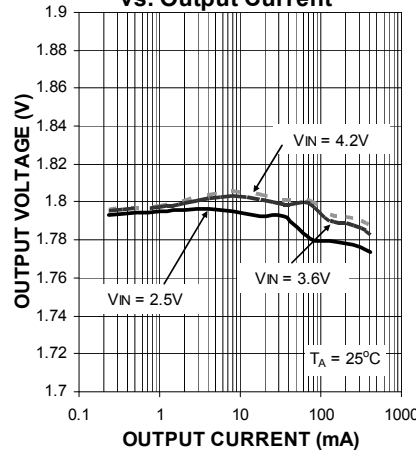

Output Voltage vs. Input Voltage

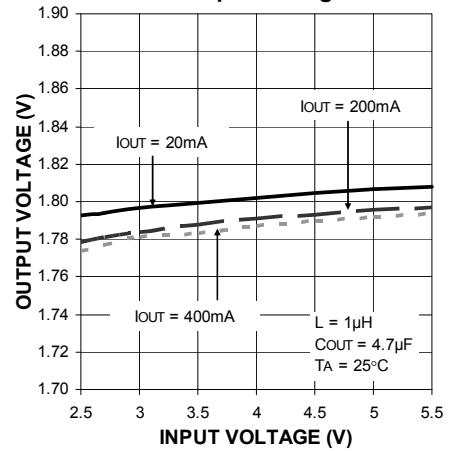

Output Voltage vs. Temperature

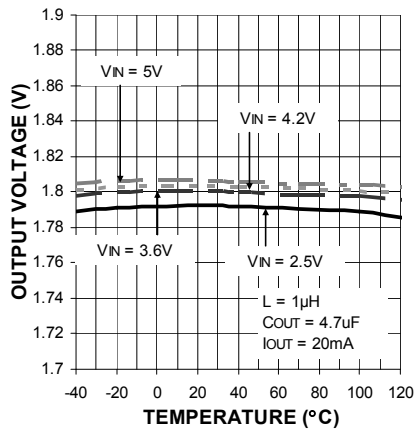

Enable Threshold vs. Temperature

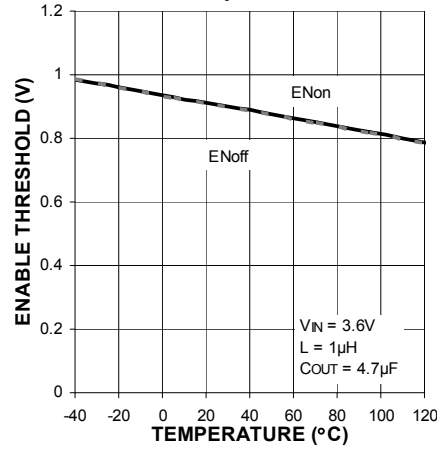

Enable Threshold vs. Input Voltage

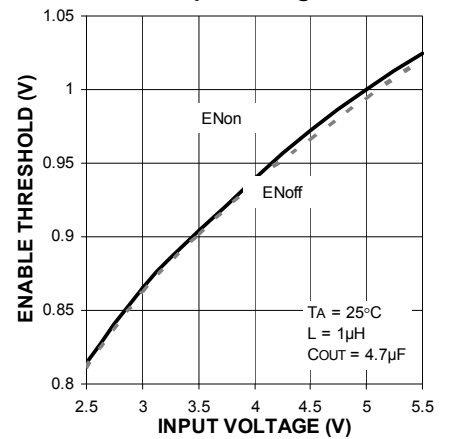

Typical Characteristics (Continued)

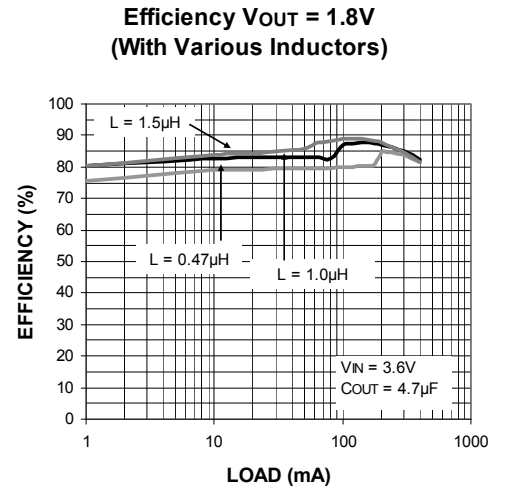
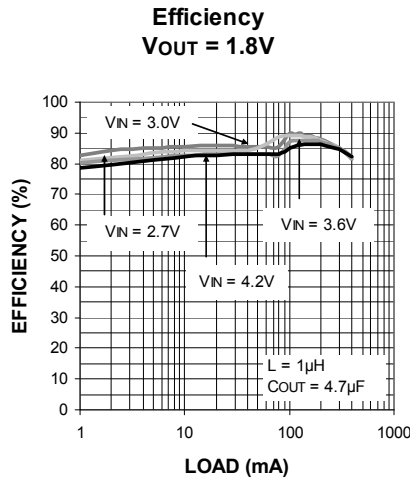
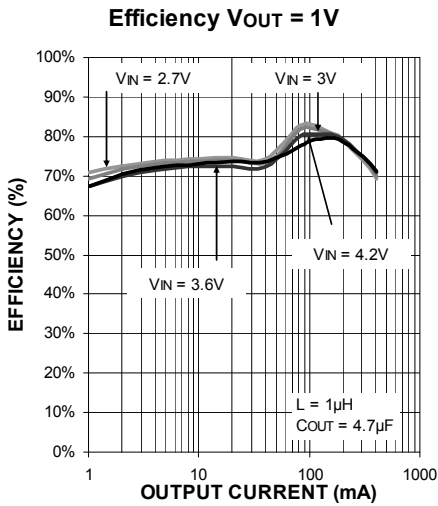
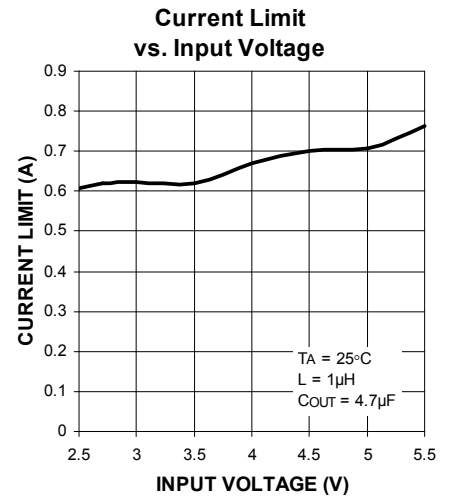
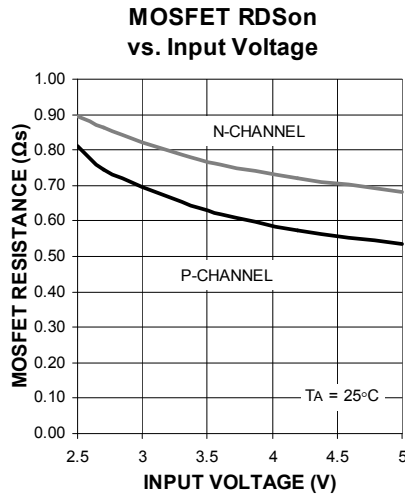
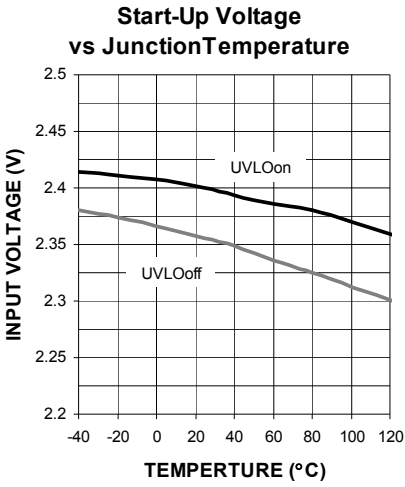

Functional Characteristics

Switching Waveform - Discontinuous Mode

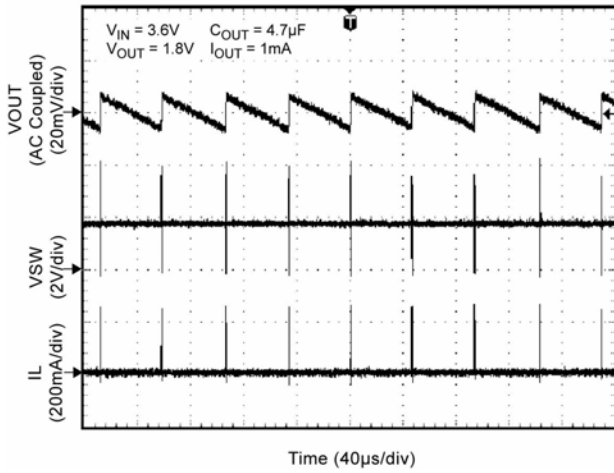

Switching Waveform - Discontinuous Mode

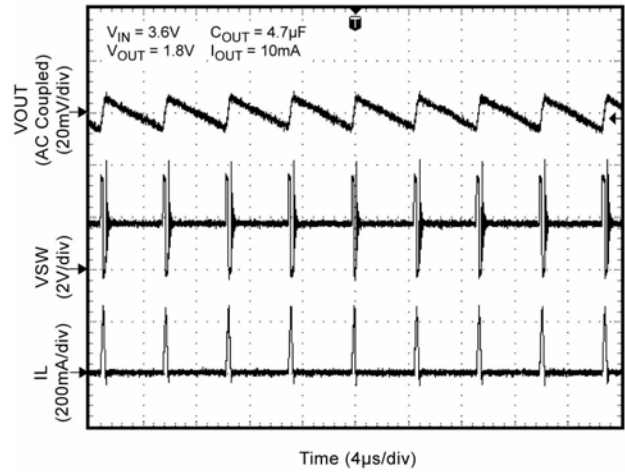

Switching Waveform - Discontinuous Mode

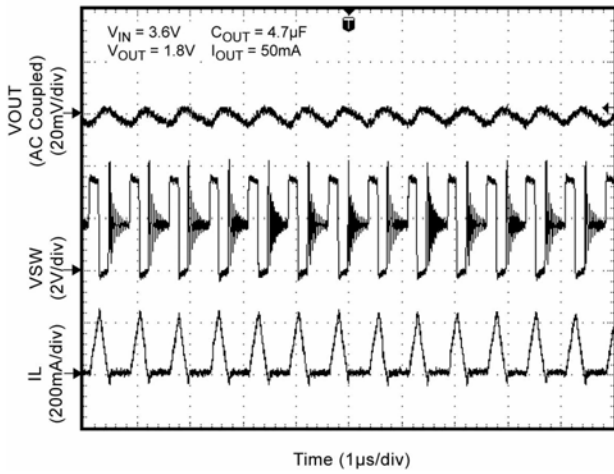

Switching Waveform - Continuous Mode

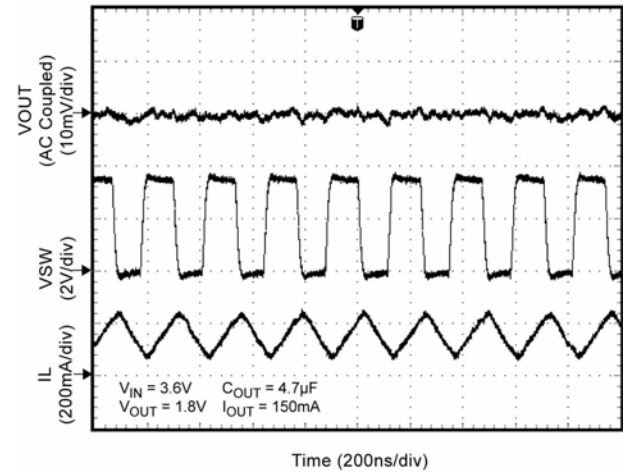

Switching Waveform - Continuous Mode

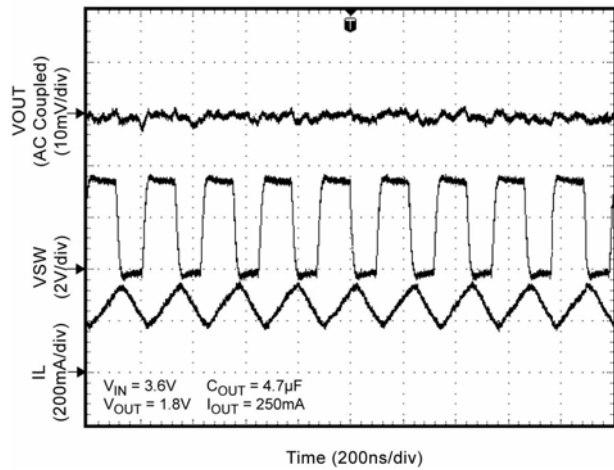

Switching Waveform - Continuous Mode

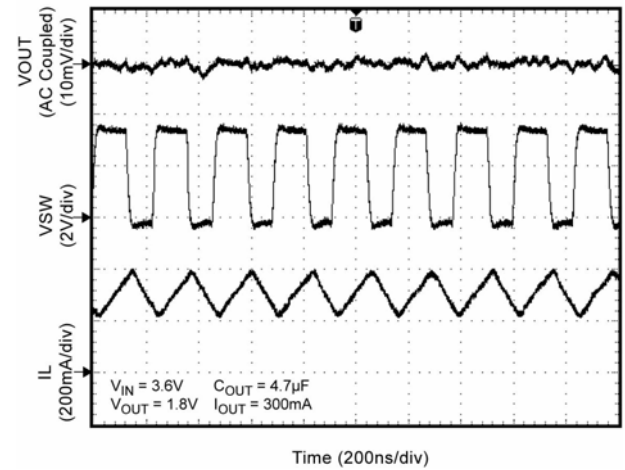

Functional Characteristics (Continued)

Start-Up Waveform

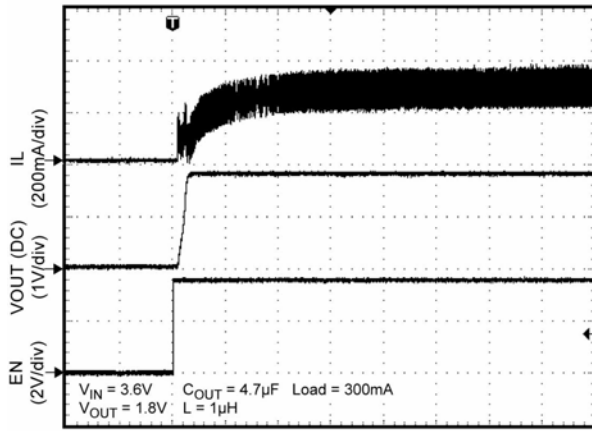

Start-Up Waveform

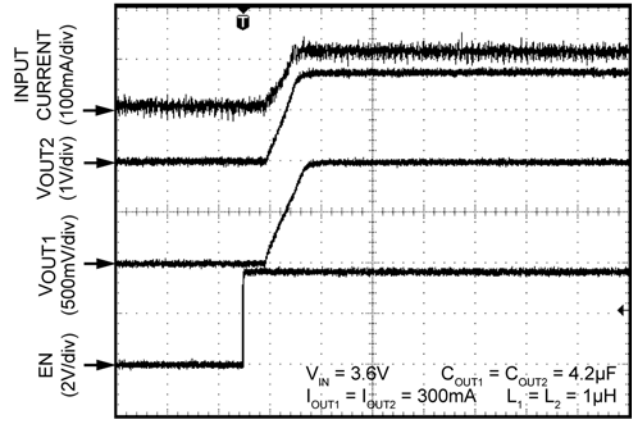

Load Transient

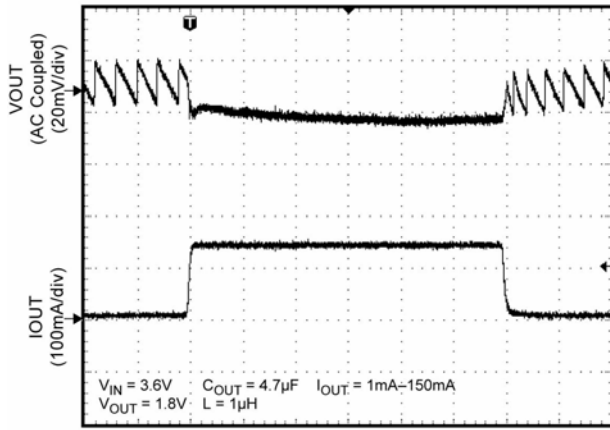

Load Transient

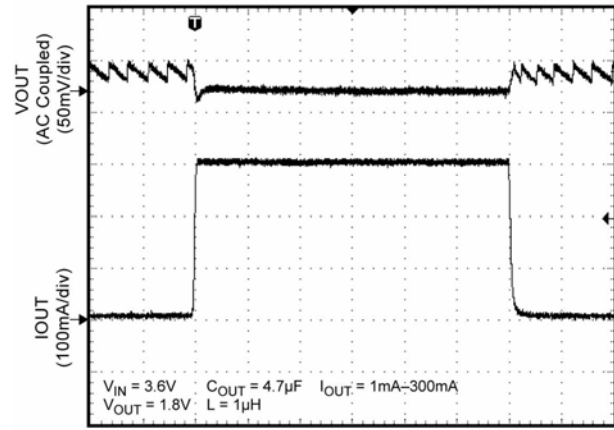

Load Transient

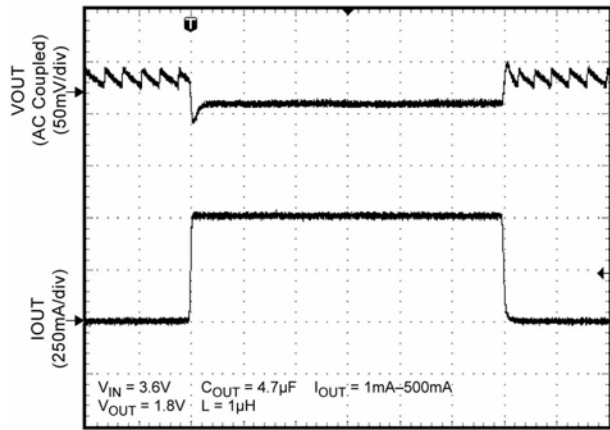

Load Transient

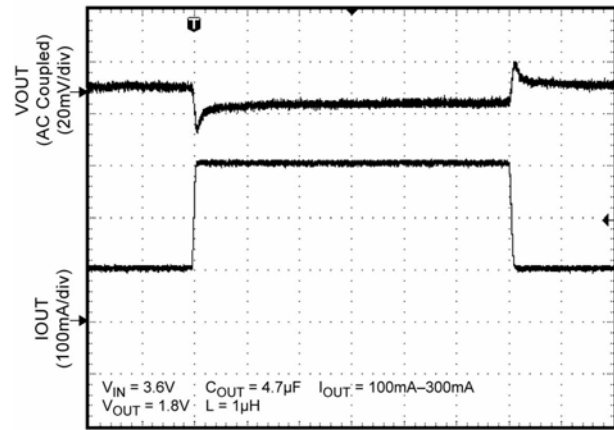

Functional Characteristics (Continued)

Line Transient

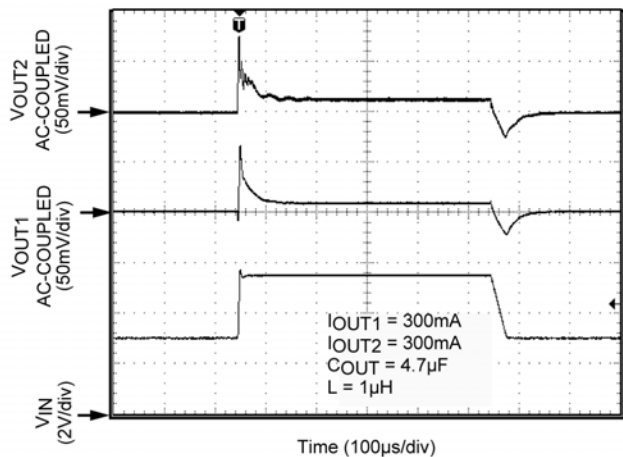

Line Transient

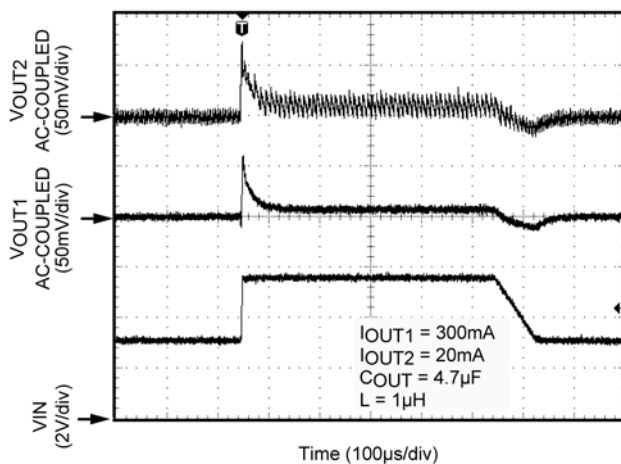

Functional Diagram

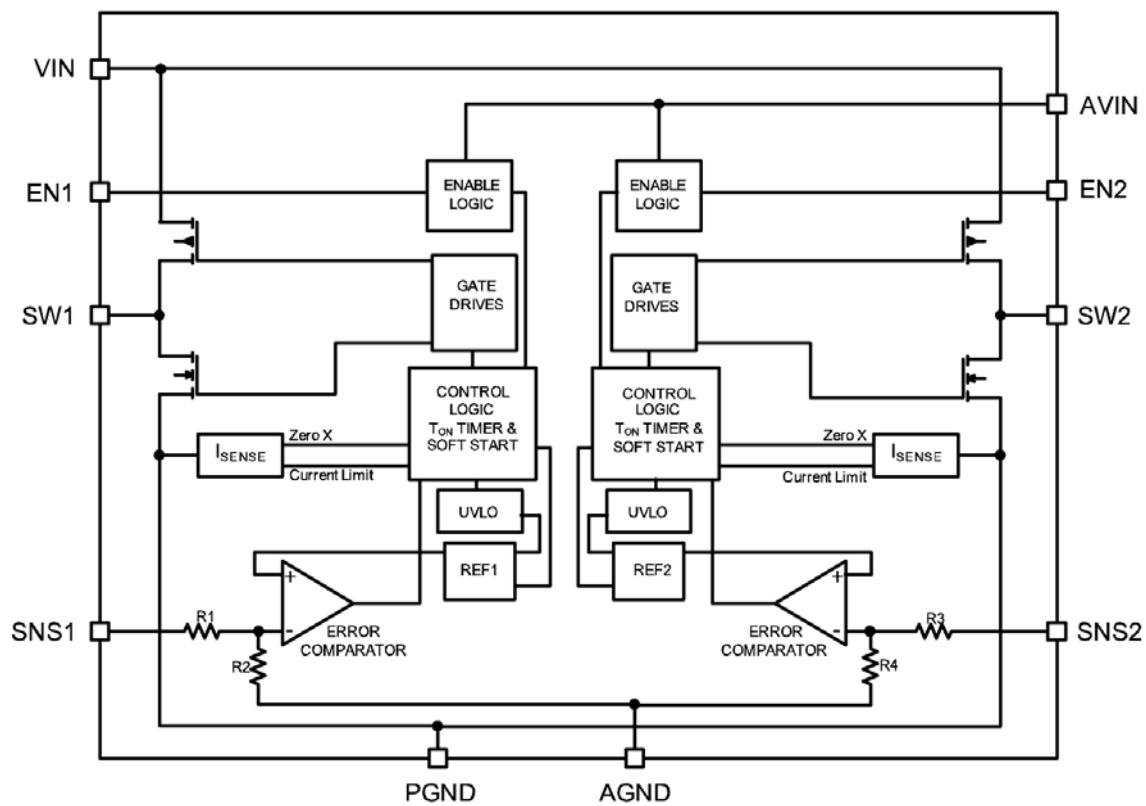

MIC23254 Simplified Fixed Output Block Diagram

Functional Description

VIN

The VIN provides power to the internal MOSFETs for the switch mode regulator along with the current limit sensing. The VIN operating range is 2.5V to 5.5V so an input capacitor with a minimum of 6.3V voltage rating is recommended. Due to the high switching speed, a minimum of 2.2 μ F bypass capacitor placed close to VIN and the power ground (PGND) pin is required. Based upon size, performance and cost, a TDK C1608X5R0J475K, size 0603, 4.7 μ F ceramic capacitor is highly recommended for most applications. Refer to the layout recommendations for details.

AVIN

The analog VIN (AVIN) provides power to the analog supply circuitry. AVIN and VIN must be tied together. Careful layout should be considered to ensure high frequency switching noise caused by VIN is reduced before reaching AVIN. A 0.01 μ F bypass capacitor placed as close to AVIN as possible is recommended. See layout recommendations for details.

EN1/EN2

The enable pins (EN1 and EN2) control the on and off states of outputs 1 and 2, respectively. A logic high signal on the enable pin activates the output voltage of the device. A logic low signal on each enable pin deactivates the output. MIC23254 features built-in soft-start circuitry that reduces in-rush current and prevents the output voltage from overshooting at start up.

SW1/SW2

The switching pin (SW1 or SW2) connects directly to one end of the inductor (L1 or L2) and provides the current path during switching cycles. The other end of the inductor is connected to the load and SNS pin. Due to the high speed switching on this pin, the switch node should be routed away from sensitive nodes.

SNS1/SNS2

The SNS pin (SNS1 or SNS2) is connected to the output of the device to provide feedback to the control circuitry. A minimum of 2.2 μ F bypass capacitor should be connected in shunt with each output. Based upon size, performance and cost, a TDK C1608X5R0J475K, size 0603, 4.7 μ F ceramic capacitor is highly recommended for most applications. In order to reduce parasitic inductance, it is good practice to place the output bypass capacitor as close to the inductor as possible. The SNS connection should be placed close to the output bypass capacitor. Refer to the layout recommendations for more details.

PGND

The power ground (PGND) is the ground path for the high current in PWM mode. The current loop for the power ground should be as small as possible and separate from the Analog ground (AGND) loop. Refer to the layout recommendations for more details.

AGND

The signal ground (AGND) is the ground path for the biasing and control circuitry. The current loop for the signal ground should be separate from the Power Ground (PGND) loop. Refer to the layout recommendations for more details.

Applications Information

The MIC23254 is designed for high performance with a small solution size. With a dual 400mA output inside a tiny 2mm x 2mm Thin MLF[®] package and requiring only six external components, the MIC23254 meets today's miniature portable electronic device needs. While small solution size is one of its advantages, the MIC23254 is big in performance. Using the HyperLight Load™ switching scheme, the MIC23254 is able to maintain high efficiency throughout the entire load range while providing ultra-fast load transient response. Even with all the given benefits, the MIC23254 can be as easy to use as linear regulators. The following sections provide an over view of implementing MIC23254 into related applications

Input Capacitor

A minimum of 2.2μF ceramic capacitor should be placed close to the VIN pin and PGND pin for bypassing. A TDK C1608X5R0J475K, size 0603, 4.7μF ceramic capacitor is recommended based upon performance, size and cost. A X5R or X7R temperature rating is recommended for the input capacitor. Y5V temperature rating capacitors, aside from losing most of their capacitance over temperature, can also become resistive at high frequencies. This reduces their ability to filter out high-frequency noise.

Output Capacitor

The MIC23254 was designed for use with a 2.2μF or greater ceramic output capacitor. Increasing the output capacitance will lower output ripple and improve load transient response but could increase solution size or cost. A low equivalent series resistance (ESR) ceramic output capacitor such as the TDK C1608X5R0J475K, size 0603, 4.7μF ceramic capacitor is recommended based upon performance, size and cost. Either the X7R or X5R temperature rating capacitors are recommended. The Y5V and Z5U temperature rating capacitors, aside from the undesirable effect of their wide variation in capacitance over temperature, become resistive at high frequencies.

Inductor Selection

Inductor selection will be determined by the following (not necessarily in the order of importance):

1. Inductance
2. Rated current value
3. Size requirements
4. DC resistance (DCR)

The MIC23254 was designed for use with an inductance range from 0.47μH to 4.7μH. Typically, a 1μH inductor is recommended for a balance of transient response, efficiency and output ripple. For faster transient response a 0.47μH inductor may be used. For lower output ripple, a 4.7μH is recommended.

Maximum current ratings of the inductor are generally given in two methods; permissible DC current and saturation current. Permissible DC current can be rated either for a 40°C temperature rise or a 10% to 20% loss in inductance. Ensure the inductor selected can handle the maximum operating current. When saturation current is specified, make sure that there is enough margin so that the peak current of the inductor does not cause it to saturate. Peak current can be calculated as follows:

$$I_{PEAK} = \left[I_{OUT} + V_{OUT} \left(\frac{1 - V_{OUT} / V_{IN}}{2 \times f \times L} \right) \right]$$

As shown by the previous calculation, the peak inductor current is inversely proportional to the switching frequency and the inductance; the lower the switching frequency or the inductance the higher the peak current. As input voltage increases the peak current also increases.

The size of the inductor depends on the requirements of the application. Refer to the Application Circuit and Bill of Material for details.

DC resistance (DCR) is also important. While DCR is inversely proportional to size, DCR can represent a significant efficiency loss. Refer to the Efficiency Considerations.

Compensation

The MIC23254 is designed to be stable with a 0.47μH to 4.7μH inductor with a minimum of 2.2μF ceramic (X5R) output capacitor.

Efficiency Considerations

Efficiency is defined as the amount of useful output power, divided by the amount of power supplied:

$$\text{Efficiency Loss} = \left[1 - \left(\frac{V_{OUT} \times I_{OUT}}{V_{OUT} \times I_{OUT} + L_{PD}} \right) \right] \times 100$$

Maintaining high efficiency serves two purposes. It reduces power dissipation in the power supply, reducing the need for heat sinks and thermal design considerations and it reduces consumption of current for battery powered applications. Reduced current draw from a battery increases the devices operating time and is critical in hand held devices.

There are two types of losses in switching converters; DC losses and switching losses. DC losses are simply the power dissipation of I^2R . Power is dissipated in the high side switch during the on cycle. Power loss is equal to the high-side MOSFET $R_{DS(ON)}$ multiplied by the Switch Current squared. During the off cycle, the low side N-channel MOSFET conducts, also dissipating power. Device operating current also reduces efficiency. The product of the quiescent (operating) current and the supply voltage is another DC loss. The current required driving the gates on and off at a constant 4MHz frequency and the switching transitions make up the switching losses.

From that, the loss in efficiency due to inductor resistance can be calculated as follows:

$$\text{Efficiency Loss} = \left[1 - \left(\frac{V_{OUT} \times I_{OUT}}{V_{OUT} \times I_{OUT} + L_{PD}} \right) \right] \times 100$$

Efficiency loss due to DCR is minimal at light loads and gains significance as the load is increased. Inductor selection becomes a trade-off between efficiency and size in this case.

HyperLight Load Mode™

The MIC23254 uses a minimum on and off time proprietary control loop (patented by Micrel). When the output voltage falls below the regulation threshold, the error comparator begins a switching cycle that turns the PMOS on and keeps it on for the duration of the minimum-on-time. This increases the output voltage. If the output voltage is over the regulation threshold, then the error comparator turns the PMOS off for a minimum-off-time until the output drops below the threshold. The NMOS acts as an ideal rectifier that conducts when the PMOS is off. Using a NMOS switch instead of a diode allows for lower voltage drop across the switching device when it is on. The asynchronous switching combination between the PMOS and the NMOS allows the control loop to work in discontinuous mode for light load operations. In discontinuous mode, the MIC23254 works in pulse frequency modulation (PFM) to regulate the output. As the output current increases, the off-time decreases, thus providing more energy to the output. This switching scheme improves the efficiency of MIC23254 during light load currents by only switching when it is needed. As the load current increases, the MIC23254 goes into continuous conduction mode (CCM) and switches at a frequency centered at 4MHz. The equation to calculate the load when the MIC23254 goes into continuous conduction mode may be approximated by the following formula:

$$I_{LOAD} > \left(\frac{(V_{IN} - V_{OUT}) \times D}{2L \times f} \right)$$

Efficiency
V_{OUT} = 1.8V

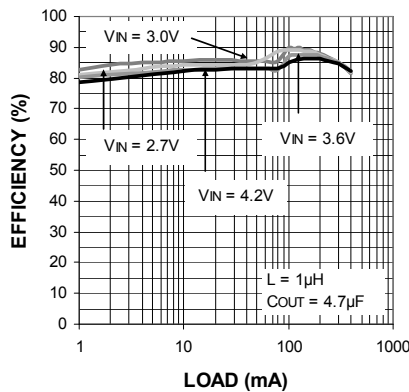

The figure above shows an efficiency curve. From no load to 100mA, efficiency losses are dominated by quiescent current losses, gate drive and transition losses. By using the HyperLight Load™ mode the MIC23254 is able to maintain high efficiency at low output currents.

Over 100mA, efficiency loss is dominated by MOSFET $R_{DS(ON)}$ and inductor losses. Higher input supply voltages will increase the Gate-to-Source threshold on the internal MOSFETs, thereby reducing the internal $R_{DS(ON)}$. This improves efficiency by reducing DC losses in the device. All but the inductor losses are inherent to the device. In which case, inductor selection becomes increasingly critical in efficiency calculations. As the inductors are reduced in size, the DC resistance (DCR) can become quite significant. The DCR losses can be calculated as follows:

$$\text{DCR Loss} = I_{OUT}^2 \times \text{DCR}$$

As shown in the previous equation, the load at which MIC23254 transitions from HyperLight Load™ mode to PWM mode is a function of the input voltage (V_{IN}), output voltage (V_{OUT}), duty cycle (D), inductance (L) and frequency (f). This is illustrated in the graph below. Since the inductance range of MIC23254 is from $0.47\mu\text{H}$ to $4.7\mu\text{H}$, the device may then be tailored to enter HyperLight Load™ mode or PWM mode at a specific load current by selecting the appropriate inductance. For example, in the graph below, when the inductance is $4.7\mu\text{H}$ the MIC23254 will transition into PWM mode at a load of approximately 5mA. Under the same condition, when the inductance is $1\mu\text{H}$, the MIC23254 will transition into PWM mode at approximately 70mA.

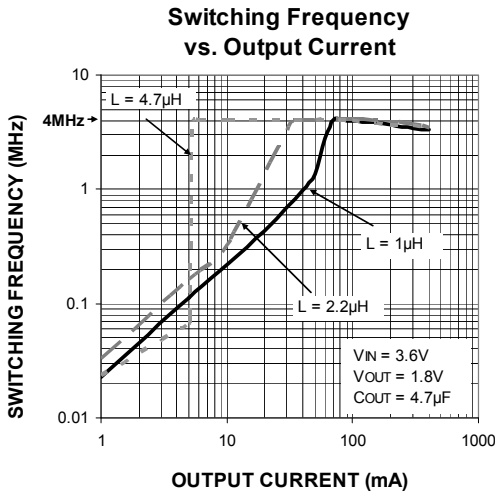

Power Dissipation Considerations

As with all power devices, the ultimate current rating of the output is limited by the thermal properties of the package and the PCB it is mounted on. There is a simple, ohms law type relationship between thermal resistance, power dissipation and temperature which are analogous to an electrical circuit:

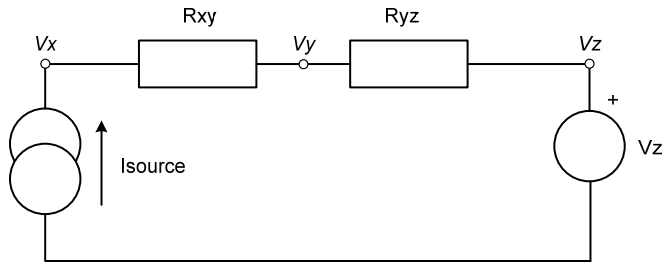

From this simple circuit we can calculate V_x if we know I_{source} , V_z and the resistor values, R_{xy} and R_{yz} using the equation:

$$V_x = I_{source} \cdot (R_{xy} + R_{yz}) + V_z$$

Thermal circuits can be considered using these same rules and can be drawn similarly replacing current sources with Power dissipation (in Watts), Resistance with Thermal Resistance (in $^{\circ}\text{C}/\text{W}$) and Voltage sources with temperature (in $^{\circ}\text{C}$):

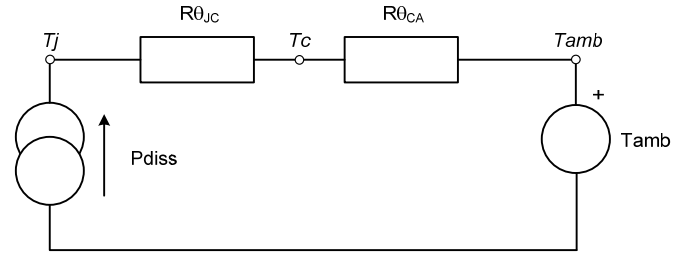

Now replacing the variables in the equation for V_x , we can find the junction temperature (T_J) from power dissipation, ambient temperature and the known thermal resistance of the PCB ($R_{\theta_{CA}}$) and the package ($R_{\theta_{JC}}$):

$$T_J = P_{DISS} \cdot (R_{\theta_{JC}} + R_{\theta_{CA}}) + T_{AMB}$$

As can be seen in the diagram, total thermal resistance $R_{\theta_{JA}} = R_{\theta_{JC}} + R_{\theta_{CA}}$. Hence this can also be written:

$$T_J = P_{DISS} \cdot (R_{\theta_{JA}}) + T_{AMB}$$

P_{DISS} can be calculated thus:

$$P_{DISS} = P_{OUT} \cdot \left(\frac{1}{\eta} - 1\right)$$

Where η = Efficiency taken from efficiency curves

$R_{\theta_{JC}}$ and $R_{\theta_{JA}}$ are found in the operating ratings section of the datasheet.

Example:

The MIC23254 is intended to drive a 200mA load at 1.8V, a 200mA load at 1.0V, and is placed on a printed circuit board which has a ground plane area of at least 25mm square. The Voltage source is a Li-ion battery with a lower operating threshold of 3V and the ambient temperature of the assembly can be up to 50°C.

Summary of variables:

$$I_{OUT1} = 0.2A, I_{OUT2} = 0.2A$$

$$V_{OUT1} = 1.0V, V_{OUT2} = 1.8V$$

$$V_{IN} = 3V \text{ to } 4.2V$$

$$\text{Inductor DCR} = 190m\Omega$$

$$T_{AMB} = 50^\circ C$$

$$R\theta_{JA} = 70^\circ C/W \text{ from Datasheet}$$

$\eta_1 @ 200mA = 78\%$, $\eta_2 @ 200mA = 86\%$, (worst case with $V_{IN}=4.2V$ from the Typical Characteristics Efficiency vs. Load graphs)

$$P_{DISS} = 1.0 \cdot 0.2 \cdot \left(\frac{1}{0.78} - 1\right) + 1.8 \cdot 0.2 \cdot \left(\frac{1}{0.86} - 1\right)$$

$$P_{DISS} = 0.115W$$

$$P_{IND} = 0.0076W$$

$$P_{DISS} = 0.115 - 2 \cdot (0.0076) = 0.1W$$

Therefore:

$$T_J = 0.1W \cdot (70^\circ C/W) + 50^\circ C$$

$$T_J = 57^\circ C$$

This is well below the maximum 125°C.

Subtracting the power loss from the inductors:

$$P_{IND1} = P_{IND2} = \text{Inductor DCR} \cdot I_{OUT}^2$$

$$P_{IND} = 0.19 \cdot 0.2^2$$

MIC23254 Typical Application Circuit

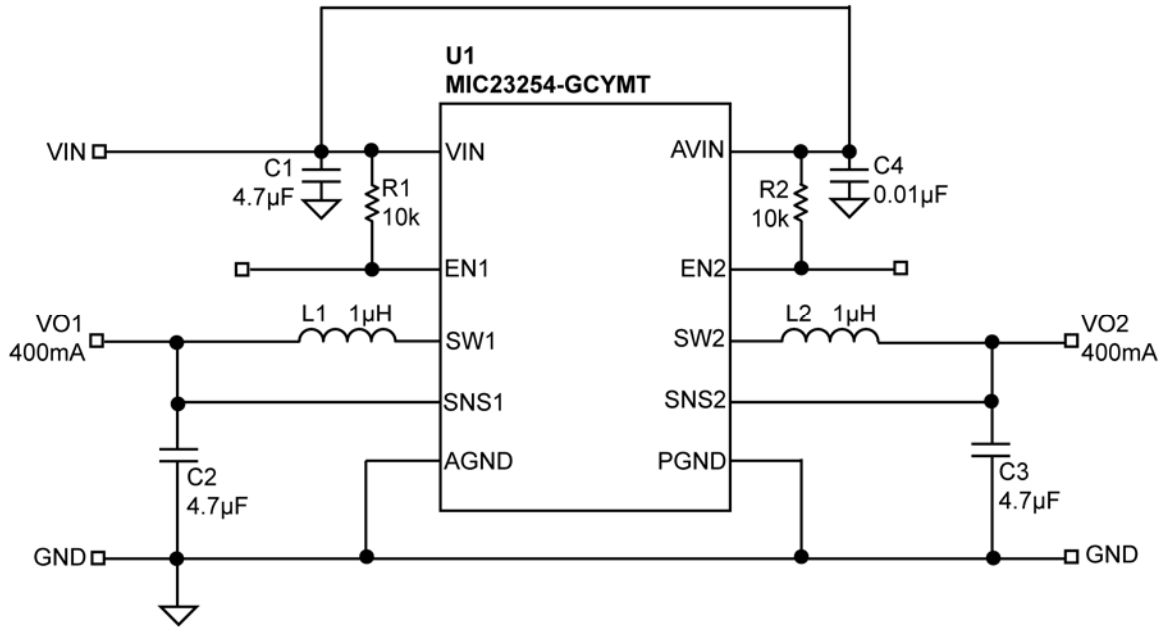

Bill of Materials

Item	Part Number	Manufacturer	Description	Qty
C1, C2, C3	C1608X5R0J475K	TDK ⁽¹⁾	4.7µF Ceramic Capacitor, 6.3V, X5R, Size 0603	3
C4	VJ0603Y103KXXAT	Vishay ⁽²⁾	0.01µF Ceramic Capacitor, 25V, X7R, Size 0603	1
R1, R2	CRCW06031002FKEA	Vishay ⁽²⁾	10kΩ, 1%, 1/16W, Size 0603	Optional
L1, L2	LQM21PN1R0MC0D	Murata ⁽³⁾	1µH, 0.8A, 190mΩ, L2mm x W1.25mm x H0.5mm	2
	LQH32CN1R0M33	Murata ⁽³⁾	1µH, 1A, 60mΩ, L3.2mm x W2.5mm x H2.0mm	
	LQM31PN1R0M00	Murata ⁽³⁾	1µH, 1.2A, 120mΩ, L3.2mm x W1.6mm x H0.95mm	
	GLF251812T1R0M	TDK ⁽¹⁾	1µH, 0.8A, 100mΩ, L2.5mm x W1.8mm x H1.35mm	
	LQM31PNR47M00	Murata ⁽³⁾	0.47µH, 1.4A, 80mΩ, L3.2mm x W1.6mm x H0.85mm	
	MIPF2520D1R5	FDK ⁽⁴⁾	1.5µH, 1.5A, 70mΩ, L2.5mm x W2mm x H1.0mm	
	EPL2010-102	Coilcraft ⁽⁵⁾	1.0µH, 1.0A, 86mΩ, L2.0mm x W1.8mm x H1.0mm	
U1	MIC23254-GCYMT	Micrel, Inc. ⁽⁶⁾	Low-Voltage, 4MHz Dual 400mA Fixed-Output Buck Regulator with HyperLight Load™ Mode	1

Notes:

1. TDK: www.tdk.com.
2. Vishay: www.vishay.com.
3. Murata: www.murata.com.
4. FDK: www.fdk.co.jp.
5. Coilcraft: www.coilcraft.com.
6. Micrel, Inc: www.micrel.com.

PCB Layout Recommendations

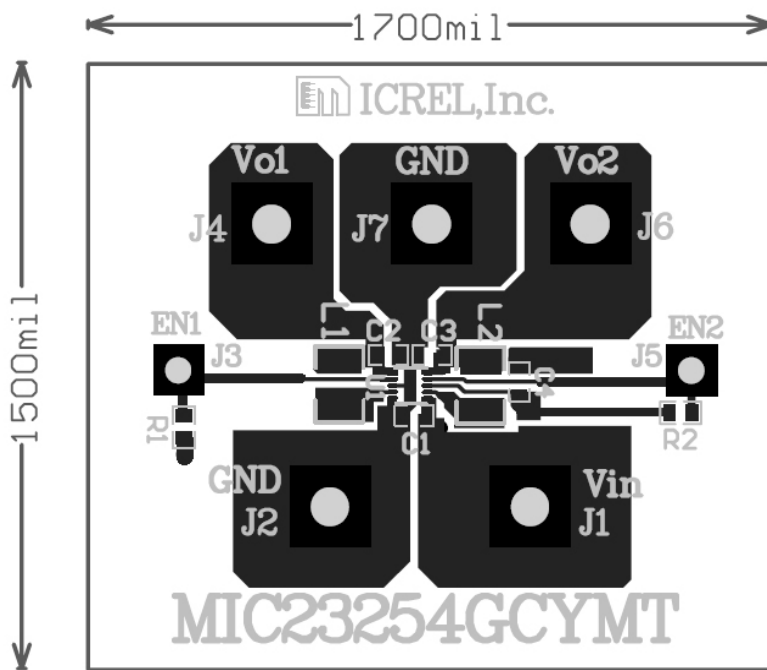

Top Layer

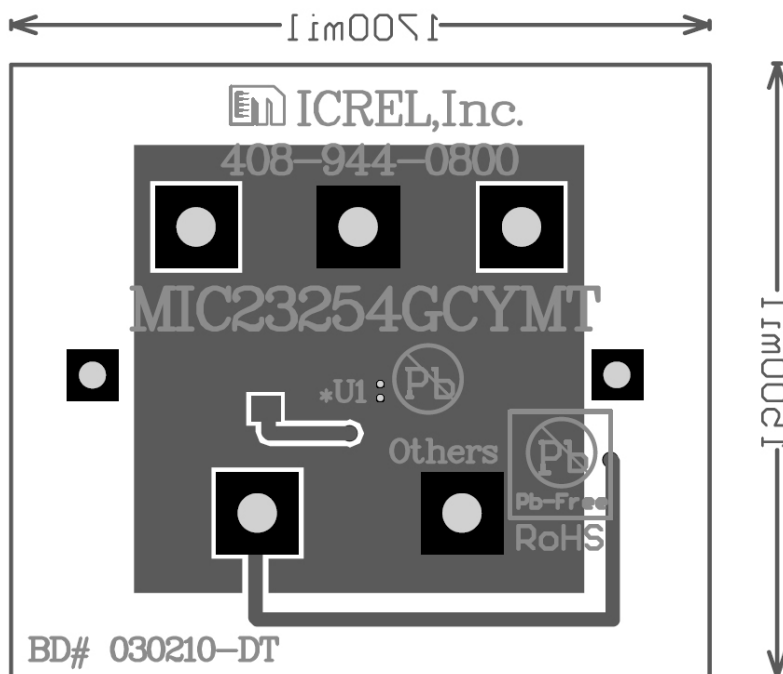

Bottom Layer

Package Information

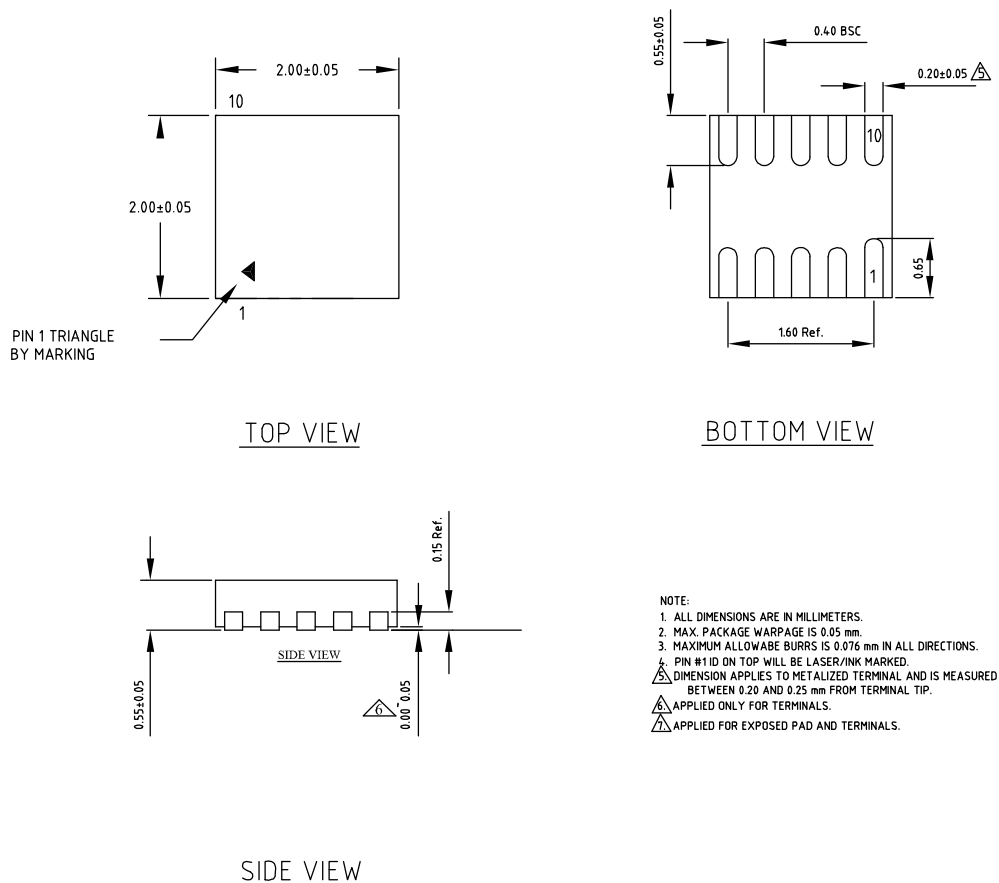

10-Pin 2mm x 2mm Thin MLF[®] (MT)

MICREL, INC. 2180 FORTUNE DRIVE SAN JOSE, CA 95131 USA
 TEL +1 (408) 944-0800 FAX +1 (408) 474-1000 WEB <http://www.micrel.com>

The information furnished by Micrel in this data sheet is believed to be accurate and reliable. However, no responsibility is assumed by Micrel for its use. Micrel reserves the right to change circuitry and specifications at any time without notification to the customer.

Micrel Products are not designed or authorized for use as components in life support appliances, devices or systems where malfunction of a product can reasonably be expected to result in personal injury. Life support devices or systems are devices or systems that (a) are intended for surgical implant into the body or (b) support or sustain life, and whose failure to perform can be reasonably expected to result in a significant injury to the user. A Purchaser's use or sale of Micrel Products for use in life support appliances, devices or systems is a Purchaser's own risk and Purchaser agrees to fully indemnify Micrel for any damages resulting from such use or sale.

© 2010 Micrel, Incorporated.