

# 0.50mm (0.02") PITCH CONNECTOR

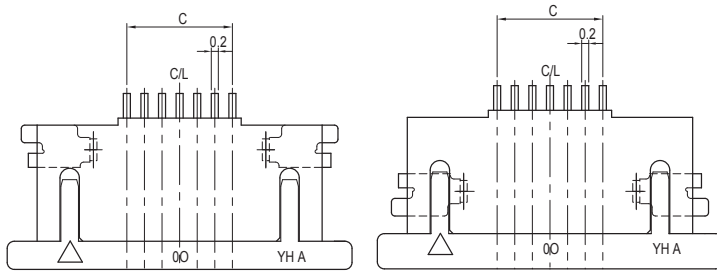

FPC/FFC Connector  
Housing

**05003HR-00A01/2 Series**  
**SMT, ZIF(Bottom Contact Type)**  
**Right Angle**

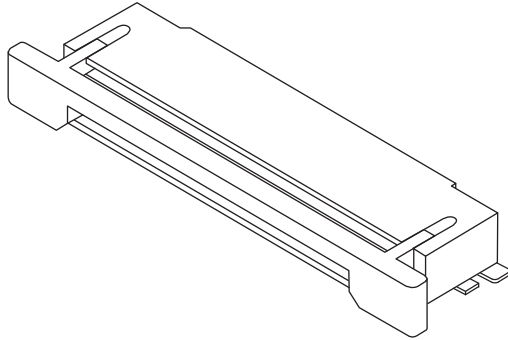

(05003HR-00A01)

(05003HR-00A02)

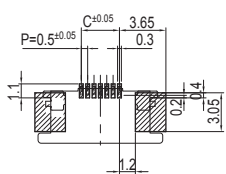
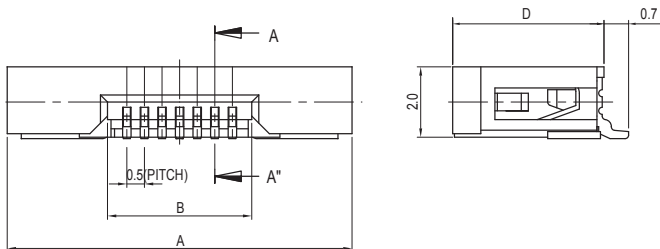

PCB LAYOUT (05003HR-00A01)

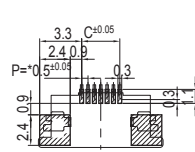

PCB LAYOUT (05003HR-00A02)

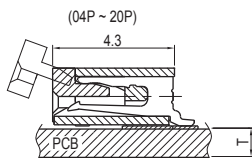

PCB ASS'Y, (05003HR-00A01)

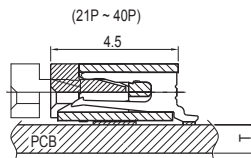

PCB ASS'Y, (05003HR-00A02)

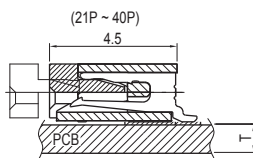

PCB ASS'Y, (05003HR-00A01)

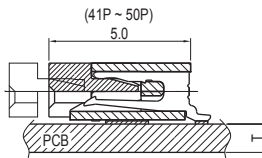

PCB ASS'Y, (05003HR-00A02)

## Material

I/NO	DESCRIPTION	TITLE	MATERIAL
1	HOUSING	05003HR	PA46, PA6T, LCP, UL 94V Grade
2	ACTUATOR	05003AS	PPS, UL 94V Grade
3	TERMINAL	05003TR	Phosphor Bronze & Tin plated
4	HOOK	05006LR	Phosphor Bronze & Tin plated

## Available Pin

PARTS NO.	A	B	C	D
05003HR-04A01/2	8.3	2.5	1.5	4.3
05003HR-05A01/2	8.8	3.0	2.0	4.3
05003HR-06A01/2	9.3	3.5	2.5	4.3
05003HR-07A01/2	9.8	4.0	3.0	4.3
05003HR-08A01/2	10.3	4.5	3.5	4.3
05003HR-09A01/2	10.8	5.0	4.0	4.3
05003HR-10A01/2	11.3	5.5	4.5	4.3
05003HR-11A01/2	11.8	6.0	5.0	4.3
05003HR-12A01/2	12.3	6.5	5.5	4.3
05003HR-13A01/2	12.8	7.0	6.0	4.3
05003HR-14A01/2	13.3	7.5	6.5	4.3
05003HR-15A01/2	13.8	8.0	7.0	4.3
05003HR-16A01/2	14.3	8.5	7.5	4.3
05003HR-17A01/2	14.8	9.0	8.0	4.3
05003HR-18A01/2	15.3	9.5	8.5	4.3
05003HR-19A01/2	15.8	10.0	9.0	4.3
05003HR-20A01/2	16.3	10.5	9.5	4.3
05003HR-21A01/2	16.8	11.0	10.0	4.5
05003HR-22A01/2	17.3	11.5	10.5	4.5
05003HR-23A01/2	17.8	12.0	11.0	4.5
05003HR-24A01/2	18.3	12.5	11.5	4.5
05003HR-25A01/2	18.8	13.0	12.0	4.5
05003HR-26A01/2	19.3	13.5	12.5	4.5
05003HR-27A01/2	19.8	14.0	13.0	4.5
05003HR-28A01/2	20.3	14.5	13.5	4.5
05003HR-29A01/2	20.8	15.0	14.0	4.5
05003HR-30A01/2	21.3	15.5	14.5	4.5
05003HR-31A01/2	21.8	16.0	15.0	4.5
05003HR-32A01/2	22.3	16.5	15.5	4.5
05003HR-33A01/2	22.8	17.0	16.0	4.5
05003HR-34A01/2	23.3	17.5	16.5	4.5
05003HR-35A01/2	23.8	18.0	17.0	4.5
05003HR-36A01/2	24.3	18.5	17.5	4.5
05003HR-37A01/2	24.8	19.0	18.0	4.5
05003HR-38A01/2	25.3	19.5	18.5	4.5
05003HR-39A01/2	25.8	20.0	19.0	4.5
05003HR-40A01/2	26.3	20.5	19.5	4.5
05003HR-41A01/2	26.8	21.0	20.0	5.0
05003HR-42A01/2	27.3	21.5	20.5	5.0
05003HR-43A01/2	27.8	22.0	21.0	5.0
05003HR-44A01/2	28.3	22.5	21.5	5.0
05003HR-45A01/2	28.8	23.0	22.0	5.0
05003HR-46A01/2	29.3	23.5	22.5	5.0
05003HR-47A01/2	29.8	24.0	23.0	5.0
05003HR-48A01/2	30.3	24.5	23.5	5.0
05003HR-49A01/2	30.8	25.0	24.0	5.0
05003HR-50A01/2	31.3	25.5	24.5	5.0

## Specification

ITEM	SPEC
Voltage Rating	AC/DC 50V
Current Rating	AC/DC 0.5A
Operating Temperature	-25°C ~ +85°C
Contact Resistance	30mΩ MAX
Withstanding Voltage	AC500V/1min
Insulation Resistance	100MΩ MIN
Applicable Wire	-
Applicable P.C.B	0.8 ~ 1.6mm
Applicable FPC/FFC	0.30±0.05mm
Solder Height	0.15mm
Crimp Tensile Strength	-
UL FILE NO	-