



Applications

- Heat Regulation
 - Ovens
 - Coffee Makers
 - Cookers
- Light Dimming
- Control of Inductive Loads
 - Motors
 - Transformers

- > **Superior Commutating Performance at High Temperature**
(di/dt)_c = 14A/ms @ (dv/dt)_c = 50V/μs
- > **Ideal for Most Demanding Applications**
- > **Alternistor/No Snubber Type**
- > **IGT 35 mA Max.**
- > **VDRM/VRMM 400, 600, 800V**

CHTA/CHTB16
High Temperature 150°C Series
16Amp - 400/600/800V - TRIAC

Absolute Maximum Ratings

	CONDITIONS	SYMBOL	RATING
RMS On-State Current (full sine wave)	T _c = 125°C T _c = 115°C TO-220AB TO-220AB Iso	I _{T(RMS)}	16A
Non Repetitive Surge Peak On-State Current (Full Cycle, T _j Initial = 25°C)	F = 50 Hz F = 60 Hz	I _{TSM}	180A 190A
I ² t Value for fusing	tp = 10 ms	I ² t	150A ² s
Critical rate of rise of on-state current I _G = 2 x I _{GT} , tr < 100 ns, T _j = 150°C		di/dt	100A/μs
Peak Gate Current @ T _j = 150°C	tp = 20 μs	I _{GM}	4A
Average Gate Power Dissipation @ T _j = 150°C		PG(AV)	1W
Storage Temperature Range		T _{stg}	-40 to +150°C
Operating Junction Temperature Range		T _j	-40 to +150°C
Isolation Voltage (CHTA Series only)		V _{ISO}	2500 V _{RMS}

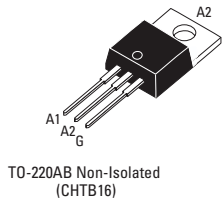
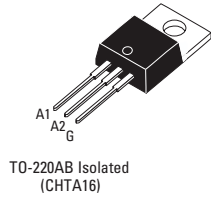

Electrical Characteristics

I _{GT} MAX @ V _D = 12 V, R _L = 30Ω ^{NOTE 1}	QI-II-III	35mA	
V _{GT} MAX @ V _D = 12 V, R _L = 30Ω	QI-II-III	1.3V	
V _{GD} MIN @ V _D = V _{DRM} , R _L = 3.3kΩ	T _j = 150°C	QI-II-III	0.15V
I _H MAX @ I _T = 100 mA ^{NOTE 2}			35mA
I _L MAX @ I _G = 1.2 I _{GT}	QI-III		50mA
I _L MAX @ I _G = 1.2 I _{GT}	Q-II		80mA
dv/dt MIN @ V _D = 67%V _{DRM} (gate open) ^{NOTE 2}	T _j = 150°C		500V/μs
(di/dt) _c MIN without snubber ^{NOTES 2 & 4}	T _j = 150°C		14A/ms

Static Characteristics

V _T MAX @ I _{TM} = 22.5 A, tp = 380μs ^{NOTE 2}	T _j = 25°C		1.5V
V _{to} MAX @ Threshold Voltage ^{NOTE 2}	T _j = 150°C		0.8V
R _d MAX @ Dynamic Resistance ^{NOTE 2}	T _j = 150°C		25mΩ
I _{DRM} MAX @ V _{DRM} = V _{RRM}	T _j = 25°C		5μA
I _{RRM} MAX @ V _{DRM} = V _{RRM}	T _j = 150°C		5.5mA

GENERAL NOTES

1. Minimum IGT is guaranteed at 5% of IGT max.
2. For both polarities of A2 referenced to A1
3. All parameters at 25 degrees C unless otherwise specified.
4. Commutating dv/dt = 50V/μs, (exponential to 200Vpk)

ISO9001 Certified

Thermal Resistances

		SYMBOL	RATING
Junction to Case (AC)	TO-220AB	$R_{th(j-c)}$	1.4°C/W
Junction to Case (AC)	TO-220AB Isolated	$R_{th(j-c)}$	2.3°C/W
Junction to Ambient	TO-220AB	$R_{th(j-a)}$	60°C/W
Junction to Ambient	TO-220AB Isolated	$R_{th(j-a)}$	60°C/W

Part Number Designation

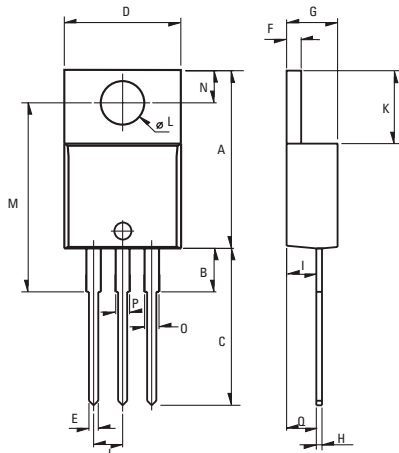

Weight: 2.3g (0.08 oz)

Dimensions

REF.	Millimeters			Inches		
	Min.	Typ.	Max.	Min.	Typ.	Max.
A	15.24		15.75	0.6		0.62
B		3.23			0.127	
C	12.78		13.79	0.503		0.543
D	9.96		10.36	0.392		0.408
E	0.69		0.94	0.027		0.037
F	1.22		1.32	0.048		0.052
G	4.62		4.83	0.182		0.19
H	0.46		0.61	0.018		0.024
I	2.49		2.84	0.098		0.112
J	2.39		2.69	0.094		0.106
K	6.48		6.88	0.255		0.271
L	3.78		3.89	0.149		0.153
M	15.49	16	16.51	0.61	0.63	0.65
N	2.59		2.9	0.102		0.114
O	0.99		1.55	0.039		0.061
P	0.99		1.55	0.039		0.061
Q		2.67			0.105	

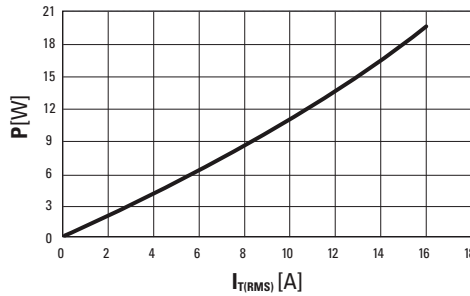
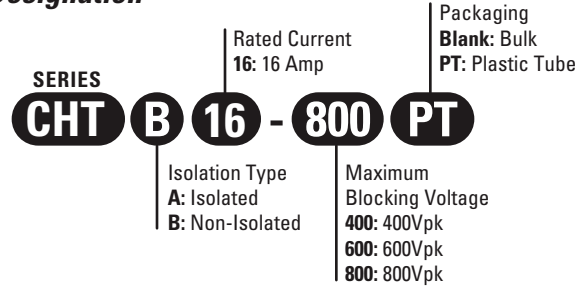

Fig. 1: Power dissipation versus RMS on-state current (full cycle).

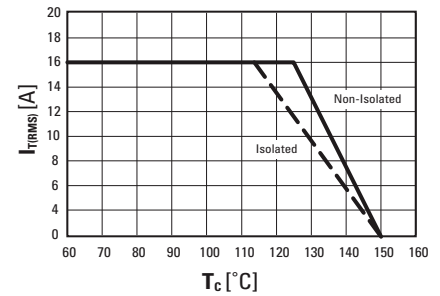

Fig. 2: RMS on-state current versus case temperature (full cycle)

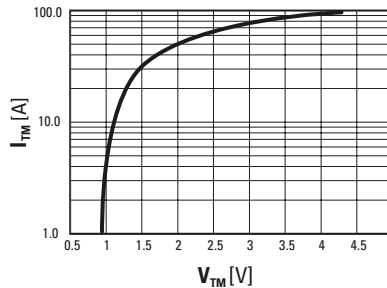

Fig. 3: On-state current versus on-state voltage (instantaneous values)

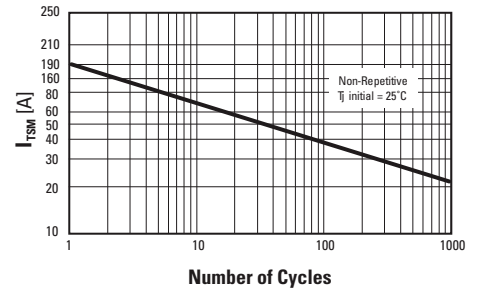

Fig. 4: Non-repetitive surge peak on-state current versus number of cycles.

ISO9001 Certified

Approvals

UL Recognized Component - E72445
(For CHTA series)

USA

Sales Support (866) 258-5057
 Tech Support (866) 258-5057
 Fax (619) 690-7432
 Email: sales@cynergy3.com
 Cynergy3 Components
 2320 Paseo de las Americas, Suite 104
 San Diego, CA 92154

EUROPE - UK

Telephone +44 (0) 1202 897969
 Fax +44 (0) 1202 891918
 Email: sales@cynergy3.com
 Cynergy3 Components Ltd.
 7 Cobham Road
 Ferndown Industrial Estate
 Wimborne, Dorset BH21 7PE

ASIA - Thailand

Telephone +66 (0)2 665 2517
 Fax +66 (0)2 665 2588
 Cynergy3 Components Asia
 18/8 Fico Place 12th Floor
 Soi Sukhumvit 21 (Asoke)
 Klongtoey Nua, Wattana
 Bangkok, Thailand 10110