

PLEASE CHECK WWW.MOLEX.COM FOR LATEST PART INFORMATION

Part Number: [0351820293](#)
Status: **Active**
Description: 1.78mm (.070") Tab, 8.70mm (.343") Pitch Wire-to-Wire Male Housing TPA™, 2 Circuits, Vertical

Documents:

[Drawing \(PDF\)](#) [Product Specification PS-35182-003 \(PDF\)](#)
[Product Specification PS-35180-002 \(PDF\)](#) [RoHS Certificate of Compliance \(PDF\)](#)

General

Product Family	Accessories
Series	35182
Component Type	Retainer
Product Name	TPA™ - Term Pos Assurance

Physical

Circuits (Loaded)	2
Color - Resin	Natural
Lock to Mating Part	Yes
Material - Resin	Nylon
Number of Rows	1
Packaging Type	Bag
Temperature Range - Operating	-40°C to +120°C

Material Info

Reference - Drawing Numbers

Product Specification	PS-35180-002, PS-35182-003
Sales Drawing	SD-35182-029*

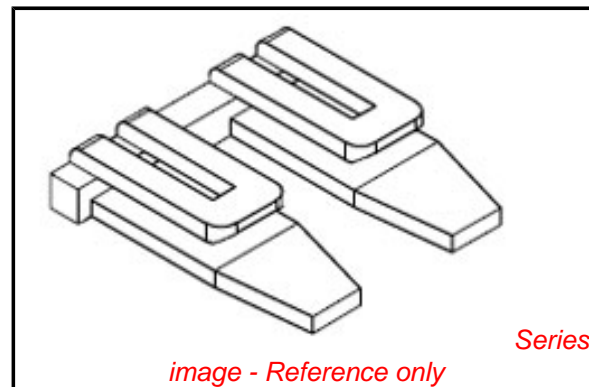

image - Reference only

EU RoHS

**ELV and RoHS
Compliant**
**REACH SVHC
Contains SVHC: No**
**Halogen-Free
Status**

China RoHS



**Need more information on product
environmental compliance?**

Email productcompliance@molex.com
 For a multiple part number RoHS Certificate of Compliance, [click here](#)

Please visit the [Contact Us](#) section for any non-product compliance questions.

Search Parts in this Series

[35182Series](#)

Use With

[35180 Wire-to-Wire Male Housing](#)

ENG. NO.
SD_35182-029*

EDP NO.

SIMILAR ITEM

PROJECT NO.
.070 MULTI CONN'

8

7

6

5

4

3

2

1

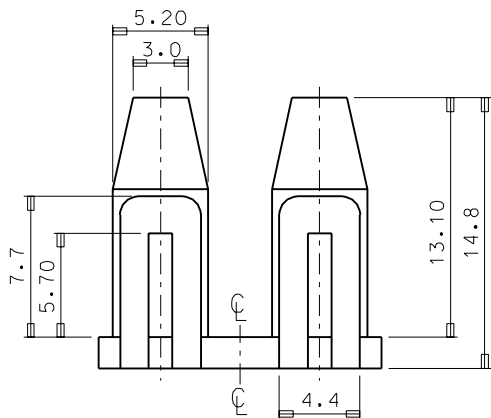
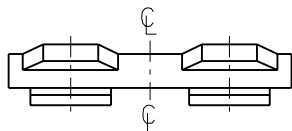

NOTES

- MATERIAL : NYLON 66 (UL94V-2)
- COLOR : 35182-0290 (NATURAL)
35182-0292 (RED)
35182-0293 (YELLOW)
35182-0294 (BLUE)
- MATCHED HOUSING : 35180-040*

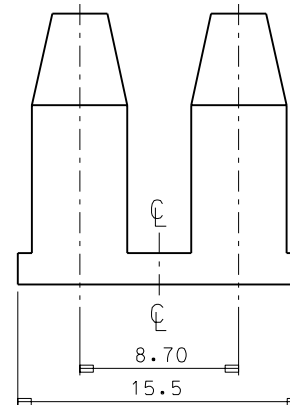
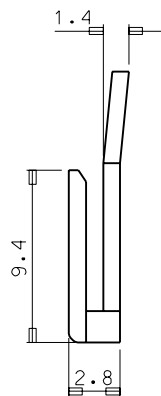
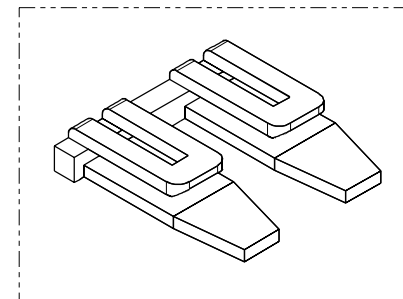

TRADE MARK
(MK2)

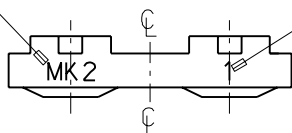

CAV. No.
(1,2,3...)

				MATERIAL SEE NOTES		molex MOLEX-KOREA CO.,LTD.	
				GENERAL TOLERANCE DIMENSION : ± 0.3 ANGLE : $\pm 1^\circ$		DRAWN BY J. S. KANG	
				DIMENSION CLASSIFICATION ▽ : CRITICAL ▼ : MAJOR () : REFERENCE		CHK'D BY	
A NEW RELEASED				PDR 94-044	95 9.28	APP'D BY	
LTR REVISION RECORD				ECN	DATE	SCALE 4/1	
REVISE ONLY ON CAD SYSTEM				---		TITLE: .070 MULTI MALE HOUSING T.P. A-2P	
						SHEET 1 of 1	
						ENG. NO. SD 35182-029*	
						REV A	