

**PLEASE CHECK WWW.MOLEX.COM FOR LATEST PART INFORMATION**

**Part Number:** [0916271001](#)  
**Status:** **Active**  
**Overview:** [rast\\_power\\_connector](#)  
**Description:** 5.00mm (.197") Pitch Appli-Mate® RAST Power IDT Housing, Direct/Indirect, Female, 3 Circuits, Glow Wire Compatible, Fully Coded, Open End Walls

**Documents:**

[3D Model](#) [Product Specification PS-91627-001 \(PDF\)](#)  
[Drawing \(PDF\)](#) [RoHS Certificate of Compliance \(PDF\)](#)

**Agency Certification**

CSA LR19980  
 UL E29179

**General**

Product Family IDT and Solder Connectors  
 Series [91627](#)  
 Crimp Quality Equipment Yes  
 Overview [rast\\_power\\_connector](#)  
 Product Name RAST 5  
 Use With RAST standard interface

**Physical**

Circuits (Loaded) 3  
 Circuits (maximum) 3  
 Color - Resin Natural (White)  
 Durability (mating cycles max) 10  
 Flammability 94V-2  
 Gender Female  
 Glow-Wire Compliant Yes  
 Lock to Mating Part None  
 Material - Metal High Performance Alloy (HPA)  
 Material - Plating Mating Tin  
 Material - Plating Termination Tin  
 Material - Resin Nylon  
 Number of Rows 1  
 Packaging Type Tray  
 Panel Mount No  
 Pitch - Mating Interface (in) 0.197 In  
 Pitch - Mating Interface (mm) 5.00 mm  
 Pitch - Term. Interface (in) 0.197 In  
 Pitch - Term. Interface (mm) 5.00 mm  
 Plating min: Mating (µin) 32  
 Plating min: Mating (µm) 0.80  
 Plating min: Termination (µin) 32  
 Plating min: Termination (µm) 0.80  
 Polarized to Mating Part Yes  
 Stackable No  
 Temperature Range - Operating -40°C to +120°C  
 Termination Interface: Style IDT or Pierce  
 Wire Size AWG 18, 22

**Electrical**

Current - Maximum per Contact 6A  
 Voltage - Maximum 250V AC

**Material Info**

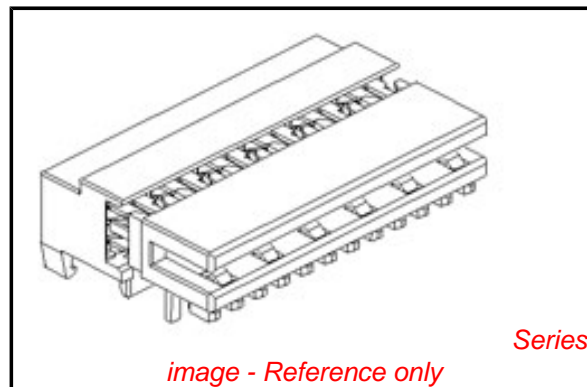

**EU RoHS**

**ELV and RoHS Compliant**  
**REACH SVHC**  
 Not Reviewed  
**Halogen-Free Status**  
**Not Reviewed**

**China RoHS**



**Need more information on product environmental compliance?**

Email [productcompliance@molex.com](mailto:productcompliance@molex.com)  
 For a multiple part number RoHS Certificate of Compliance, [click here](#)

Please visit the [Contact Us](#) section for any non-product compliance questions.

**Search Parts in this Series**

[91627Series](#)

**Mates With**

Appli-Mate RAST 2.5 Header [93071](#)

**Application Tooling | FAQ**

*Tooling specifications and manuals are found by selecting the products below. Crimp Height Specifications are then contained in the Application Tooling Specification document.*

**Global**

Description	Product #
Appli-Mate Rast 2.5 Power Manual Terminator	<a href="#">0622030000</a>
RAST 2.5 Semi-Automatic Terminator Machine For Appli-Mate™ Connectors	<a href="#">0623006000</a>

## Reference - Drawing Numbers

Application Specification	AS-91627-001
Packaging Specification	PK-91627-001
Product Specification	PS-91627-001
Sales Drawing	SD-91627-001

This document was generated on 05/27/2010

**PLEASE CHECK [WWW.MOLEX.COM](http://WWW.MOLEX.COM) FOR LATEST PART INFORMATION**

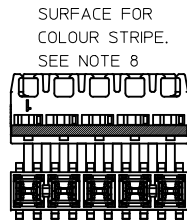
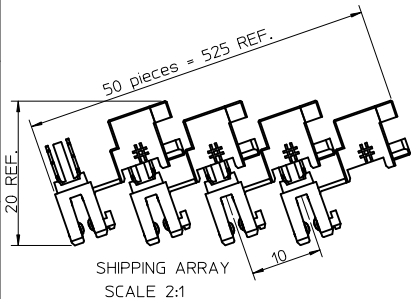
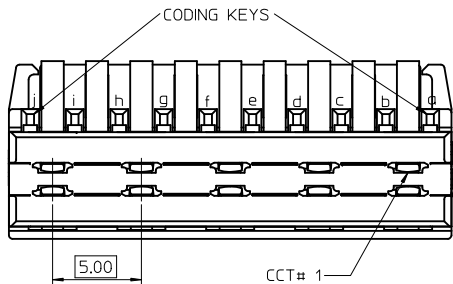
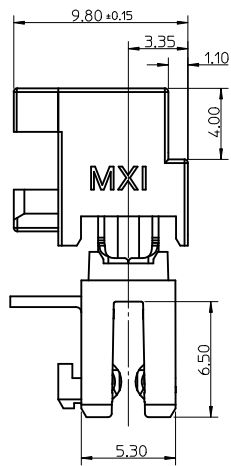
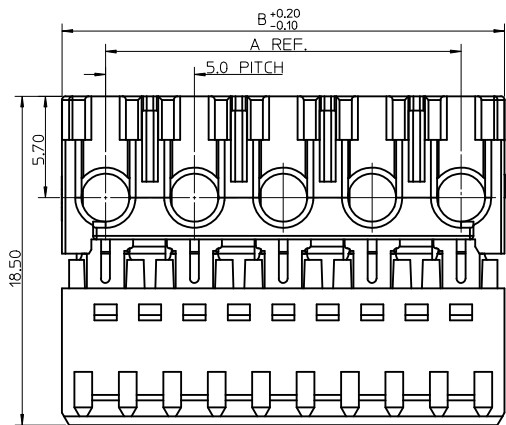

CKT	DIM A	DIM B	DIM C	DIM D
2	5	9.9	7.3	-
3	10	14.9	12.3	5
4	15	19.9	17.3	10
5	20	24.9	22.3	15
6	25	29.9	27.3	20
7	30	34.9	32.3	25
8	35	39.9	37.3	30
9	40	44.9	42.3	35
10	45	49.9	47.3	40
11	50	54.9	52.3	45
12	55	59.9	57.3	50

- NOTES:  
 1. MATERIAL: HOUSING: PA 6 TERMINAL: PHOSPHOR BRONZE OR COPPER ALLOY PLATING: TIN(6A) OR SILVER(10A)  
 2. PRODUCT SPECIFICATION: PS-91627-001  
 3. SEE SUBSEQUENT SHEETS FOR PART NUMBERING INFORMATION  
 4. LATCHES RECOMMENDED WHERE LOCKING VIA HEADER, GUIDEFRAME OR COMPONENT ENCLOSURE IS NOT POSSIBLE.  
 5. APPLICATION SPECIFICATION: AS-91627-001  
 6. 2 & 3CCT LATCH VERSIONS WILL HAVE 1 SOLID LATCH WERE APPLICABLE.  
 7. PACKAGING SPECIFICATION: PK-91627-001  
 8. COLOUR STRIPE IS OPTIONAL, AVAILABLE IN THE FOLLOWING COLOURS, BLUE, RED, GREEN & BLACK. ASTERISK IN CHART INDICATES FULL SURFACE COVERAGE.

FOR POLARIZATION END WALL OPTIONS SEE BELOW

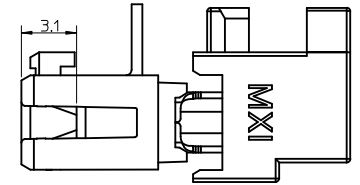
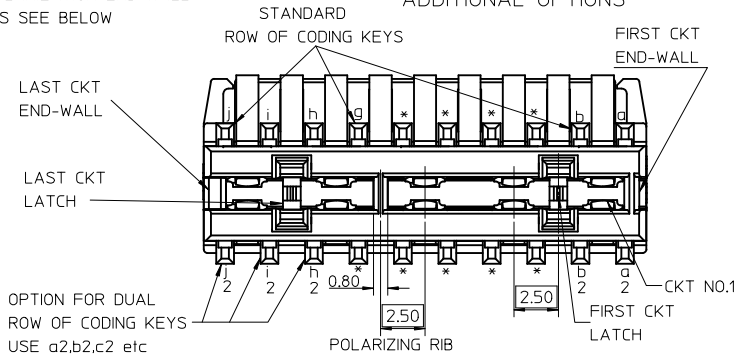

RECOMMENDED PCB LAYOUT FOR OPTIONS SHOWN (SCALE 3:1)

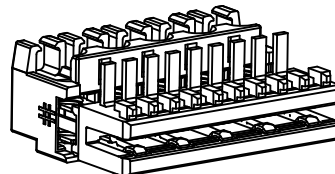

OPEN END WALL, NO POLARIZING RIB STANDARD ROW OF KEYS

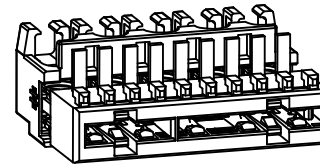

CLOSED END-WALL, POLARIZED OPTION A, LATCHES AND RIB OPTIONAL 2ND ROW OF KEYS

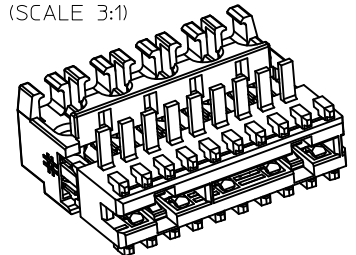

CLOSED END-WALL, POLARIZED OPTION B, LATCHES AND RIB OPTIONAL 2ND ROW OF KEYS

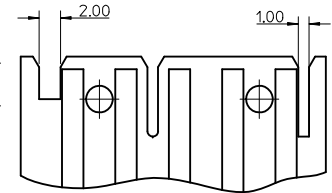
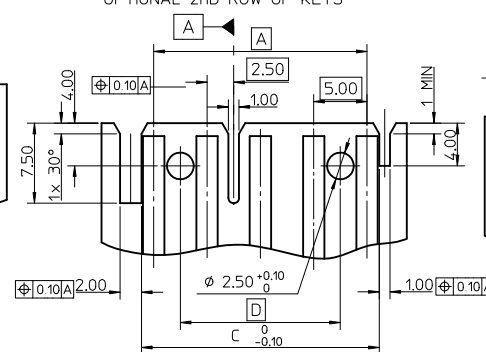
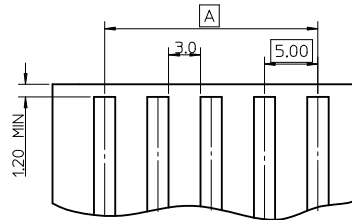

Other combinations possible:

There may be one or two latches which can be positioned between 1st and 2nd ckt and/or between 2nd and last ckt.

The polarizing rib can be between any ckt.

There may be one end wall only which must be located at the larger ckt end as polarized option A (wider and taller end wall)

NEW PART NUMBERS  
 EC NO: E2010-0325  
 DRW: BMAGUIRE 2010/03/12  
 CHK: BMAGUIRE 25/07/2003  
 APPR: BMAGUIRE 2010/05/28

QUALITY SYMBOLS  
 ▽=0  
 ▽=0  
 REV DESCRIPTION

GENERAL TOLERANCES (UNLESS SPECIFIED)

	mm	INCH
4 PLACES	± ---	± ---
3 PLACES	± ---	± ---
2 PLACES	± 0.10	± ---
1 PLACE	± 0.2	± ---

ANGULAR ± 2°

DRAFT WHERE APPLICABLE MUST REMAIN WITHIN DIMENSIONS

DIMENSION STYLE  
**MM ONLY**

DRAWN BY: LK IERNAN  
 DATE: 07/05/2003  
 CHECKED BY: BMAGUIRE  
 DATE: 25/07/2003  
 APPROVED BY: BMAGUIRE  
 DATE: 2010/04/02

SCALE: 5:1  
 DESIGN UNITS: METRIC  
 THIRD ANGLE PROJECTION

RAST PWR IDT CONN  
 5MM PITCH

MATERIAL NO. SEE CHARTS  
 DOCUMENT NO. SD-91627-001

MOLEX INCORPORATED

SHEET NO. 1 OF 3

THIS DRAWING CONTAINS INFORMATION THAT IS PROPRIETARY TO MOLEX INCORPORATED AND SHOULD NOT BE USED WITHOUT WRITTEN PERMISSION

2 CIRCUIT							
MOLEX PART NO.	TERMINAL VOID POSITION	REMOVED CODING KEYS	CONFIGURATION	LATCH BETWEEN	POLARIZING RIB BETWEEN	END WALLS	COLOUR STRIPE
91627-0001	NONE	NONE		NONE	NONE	OPEN	NONE
91627-0501	NONE	NONE		CCT 1&2	NONE	OPEN	NONE
91627-0502	NONE	NONE		CCT 1&2	NONE	A	NONE
91627-0002	NONE	NONE		NONE	NONE	OPEN	YELLOW
91627-0003	NONE	d		NONE	NONE	OPEN	YELLOW
91627-0004	NONE	NONE		NONE	NONE	OPEN	RED
91627-0005	NONE	b		NONE	NONE	OPEN	RED
91627-0006	NONE	d		NONE	NONE	OPEN	NONE
91627-0008	NONE	c		NONE	NONE	OPEN	NONE
91627-0009	NONE	a b		NONE	NONE	OPEN	NONE
91627-0010	NONE	a c		NONE	NONE	OPEN	NONE
91627-0503	NONE	NONE		CCT 1&2	NONE	B	NONE
91627-0011	NONE	b d		NONE	NONE	OPEN	NONE
91627-0012	NONE	a b c		NONE	NONE	OPEN	NONE
91627-0013	NONE	a c d		NONE	NONE	OPEN	NONE
91627-0014	NONE	b c d		NONE	NONE	OPEN	NONE
91627-0015	NONE	b		NONE	NONE	OPEN	NONE
91627-0504	NONE	a b		CCT 1&2	NONE	A	NONE
91627-0505	NONE	a c		CCT 1&2	NONE	A	NONE
91627-0506	NONE	c d		CCT 1&2	NONE	A	NONE
91627-0507	NONE	NONE		CCT 1&2	NONE	LAST	NONE
91627-0016	NONE	b c		NONE	NONE	OPEN	NONE
91627-0508	NONE	b d		CCT 1&2	NONE	A	NONE
91627-0024	NONE	a		NONE	NONE	OPEN	NONE

3 CIRCUIT							
MOLEX PART NO.	TERMINAL VOID POSITION	REMOVED CODING KEYS	CONFIGURATION	LATCH BETWEEN	POLARIZING RIB BETWEEN	END WALLS	COLOUR STRIPE
91627-1001	NONE	NONE		NONE	NONE	OPEN	NONE
91627-1002	NONE	a b c		NONE	CCT 1&2	OPEN	RED
91627-1004	NONE	NONE		NONE	CCT 1&2	OPEN	RED
91627-1501	NONE	NONE		CCT 1&2	NONE	OPEN	NONE
91627-1502	NONE	NONE		CCT 1&2	CCT 2&3	A	NONE
91627-1503	NONE	c d		CCT 1&2	NONE	A	NONE
91627-1005	NONE	a b c d e b2,c2,d2,e2		NONE	NONE	OPEN	NONE
91627-1006	NONE	b c e		NONE	NONE	OPEN	NONE
91627-1007	NONE	d e f		NONE	NONE	OPEN	NONE
91627-1504	NONE	a b c		CCT 1&2	CCT 2&3	OPEN	RED
91627-1506	NONE	NONE		CCT 2&3	CCT 1&2	A	NONE
91627-1507	NONE	NONE		CCT 1&2	CCT 2&3	A	NONE
91627-1508	NONE	NONE		CCT 2&3	CCT 1&2	OPEN	NONE
91627-1008	NONE	c d f		NONE	NONE	OPEN	NONE
91627-1009	NONE	a d e		NONE	NONE	OPEN	NONE
91627-1010	NONE	b c d		NONE	NONE	OPEN	NONE
91627-1011	NONE	a d e f		NONE	NONE	OPEN	NONE
91627-1012	NONE	a b d		NONE	NONE	OPEN	NONE
91627-1013	CCT 2	d e f		NONE	CCT 1&2	OPEN	NONE
91627-1014	NONE	b c d e		NONE	NONE	OPEN	NONE
91627-1015	NONE	a c e		NONE	NONE	OPEN	NONE
91627-1016	NONE	NONE		NONE	NONE	OPEN	BLUE*
91627-1017	NONE	d e f		NONE	CCT 1&2	OPEN	NONE

4 CIRCUIT							
MOLEX PART NO.	TERMINAL VOID POSITION	REMOVED CODING KEYS	CONFIGURATION	LATCH BETWEEN	POLARIZING RIB BETWEEN	END WALLS	COLOUR STRIPE
91627-2001	NONE	NONE		NONE	NONE	OPEN	NONE
91627-2002	NONE	d e f g h		NONE	CCT 2&3	OPEN	RED
91627-2003	NONE	NONE		NONE	CCT 2&3	OPEN	RED
91627-2501	NONE	NONE		CCT 1&2	NONE	OPEN	NONE
91627-2004	NONE	b d e f g h		NONE	CCT 2&3	OPEN	RED
91627-2005	NONE	d e f g		NONE	NONE	OPEN	NONE
91627-2006	NONE	b c d f		NONE	NONE	OPEN	NONE
91627-2007	NONE	a b e f h		NONE	NONE	OPEN	NONE
91627-2008	NONE	ALL		NONE	NONE	OPEN	NONE
91627-2009	NONE	a b f g		NONE	NONE	OPEN	NONE
91627-2503	NONE	NONE		CCT 1&2	CCT 2&3	A	NONE
91627-2010	NONE	c d e h		NONE	NONE	OPEN	NONE
91627-2011	NONE	d e f g h		NONE	NONE	OPEN	NONE

5 CIRCUIT							
MOLEX PART NO.	TERMINAL VOID POSITION	REMOVED CODING KEYS	CONFIGURATION	LATCH BETWEEN	POLARIZING RIB BETWEEN	END WALLS	COLOUR STRIPE
91627-3001	NONE	NONE		NONE	NONE	OPEN	NONE
91627-3501	NONE	NONE		CCT 1&2	NONE	OPEN	NONE
91627-3002	NONE	c d f g i		NONE	NONE	OPEN	NONE
91627-3003	NONE	a b c d e f g h i		NONE	NONE	OPEN	NONE
91627-3004	NONE	ALL		NONE	NONE	OPEN	NONE
91627-3502	NONE	NONE		CCT 1&2	CCT 3&4	A	NONE
91627-3503	NONE	NONE		CCT 1&2	CCT 4&5	A	NONE
91627-3504	NONE	NONE		CCT 1&2	CCT 4&5	OPEN	NONE
91627-3005	NONE	NONE		NONE	CCT 1&2	OPEN	NONE
91627-3006	NONE	b c d g h j		NONE	NONE	OPEN	NONE

NOTES:  
 1. FIRST CKT SIDE IS THE SIDE CLOSEST TO CKT 1  
 2. LAST CKT SIDE IS THE SIDE CLOSEST TO THE HIGHEST CKT SIZE

● - DENOTES TERMINAL POSITION LOADED  
 + - DENOTES TERMINAL POSITION VOIDED  
 I - DENOTES POSITION OF POLARIZING RIB  
 II - DENOTES POSITION OF LOCKING LATCH

3. \* - COLOUR COVERS WHOLE SURFACE

SEE SHEET 1 EC NO. E2010-0325 DRAWING NO. 25/07/2003 APPROVAL DATE 20/05/2008	QUALITY SYMBOLS ▽=0 ▽=0	GENERAL TOLERANCES (UNLESS SPECIFIED) mm INCH 4 PLACES ±.05 ±.002 3 PLACES ±.03 ±.001 2 PLACES ±.02 ±.001 1 PLACE ±.02 ±.001 ANGULAR ± 2 °	DIMENSION STYLE MM ONLY	SCALE 1:1	DESIGN UNITS METRIC	THIRD ANGLE PROJECTION
	DRAWN BY DATE K IERMAN 07/05/2003	CHECKED BY DATE B MAGUIRE 25/07/2003	APPROVED BY DATE B MAGUIRE 20/10/04/02	TITLE RAST PWR IDT CONN SMM INCORPORATED	MATERIAL NO. SD-91627-001	SHEET NO. 2 OF 3

MOLEX INCORPORATED  
 THIS DRAWING CONTAINS INFORMATION THAT IS PROPRIETARY TO MOLEX INCORPORATED AND SHOULD NOT BE USED WITHOUT WRITTEN PERMISSION

6 CIRCUIT							
MOLEX PART NO.	TERMINAL VOID POSITION	REMOVED CODING KEYS	CONFIGURATION	LATCH BETWEEN	POLARIZING RIB BETWEEN	END WALLS	COLOUR STRIPE
91627-4001	NONE	NONE		NONE	NONE	OPEN	NONE
91627-4501	NONE	NONE		CCT 1&2	NONE	OPEN	NONE
91627-4002	NONE	abc, d, g, h, j, k, l n2, 2, 2, 2, 2, 2, 2, 2 g, 2, h, 2, i, 2, k, 2		NONE	NONE	OPEN	NONE
91627-4502	NONE	NONE		CCT 1&2 CCT 5&6	CCT 3&4	OPEN	NONE
91627-4003	NONE	ALL		NONE	NONE	OPEN	NONE
91627-4004	NONE	a, i		NONE	NONE	OPEN	NONE
91627-4503	NONE	NONE		CCT 1&2	CCT 5&6	A	NONE
91627-4005	NONE	NONE		NONE	CCT 2&3	OPEN	NONE
91627-4006	NONE	c, d, e, h, j		NONE	NONE	OPEN	NONE
91627-4007	NONE	a, b, e, f g, h, i, j		NONE	NONE	OPEN	NONE
91627-4504	NONE	NONE		1&2 5&6	CCT 2&3	OPEN	NONE

7 CIRCUIT							
MOLEX PART NO.	TERMINAL VOID POSITION	REMOVED CODING KEYS	CONFIGURATION	LATCH BETWEEN	POLARIZING RIB BETWEEN	END WALLS	COLOUR STRIPE
91627-5001	NONE	NONE		NONE	NONE	OPEN	NONE
91627-5002	NONE	b, c, d, e, f, h, i, j, k, l, m		NONE	NONE	OPEN	NONE
91627-5003	NONE	b, c, e, f, g, i, j, k, m, n		NONE	NONE	OPEN	ORANGE
91627-5501	NONE	NONE		CCT 1&2	NONE	OPEN	NONE
91627-5502	NONE	NONE		CCT 1&2 CCT 6&7	NONE	A	NONE
91627-5004	NONE	c, d, g, h, i, k		NONE	NONE	OPEN	NONE
91627-5503	NONE	NONE		CCT 1&2 CCT 6&7	CCT 3&4	OPEN	NONE
91627-5504	NONE	NONE		CCT 1&2 CCT 6&7	NONE	OPEN	NONE
91627-5005	NONE	a, b, c, d, e, g h, i, j, k, l, m		NONE	NONE	OPEN	NONE
91627-5006	NONE	NONE		NONE	CCT 2&3	OPEN	NONE
91627-5505	NONE	NONE		CCT 1&2 CCT 6&7	NONE	OPEN	NONE

8 CIRCUIT							
MOLEX PART NO.	TERMINAL VOID POSITION	REMOVED CODING KEYS	CONFIGURATION	LATCH BETWEEN	POLARIZING RIB BETWEEN	END WALLS	COLOUR STRIPE
91627-6001	NONE	NONE		NONE	NONE	OPEN	NONE
91627-6501	NONE	NONE		CCT 1&2	NONE	OPEN	NONE
91627-6502	NONE	NONE		CCT 1&2 CCT 7&8	CCT 3&4	OPEN	NONE
91627-6002	NONE	NONE		NONE	CCT 2&3	OPEN	NONE

10 CIRCUIT							
MOLEX PART NO.	TERMINAL VOID POSITION	REMOVED CODING KEYS	CONFIGURATION	LATCH BETWEEN	POLARIZING RIB BETWEEN	END WALLS	COLOUR STRIPE
91627-8001	NONE	NONE		NONE	NONE	OPEN	NONE
91627-8501	NONE	NONE		CCT 1&2	NONE	OPEN	NONE

11 CIRCUIT							
MOLEX PART NO.	TERMINAL VOID POSITION	REMOVED CODING KEYS	CONFIGURATION	LATCH BETWEEN	POLARIZING RIB BETWEEN	END WALLS	COLOUR STRIPE
91627-9001	NONE	NONE		NONE	NONE	OPEN	NONE
91627-9251	NONE	NONE		CCT 1&2	NONE	OPEN	NONE

9 CIRCUIT							
MOLEX PART NO.	TERMINAL VOID POSITION	REMOVED CODING KEYS	CONFIGURATION	LATCH BETWEEN	POLARIZING RIB BETWEEN	END WALLS	COLOUR STRIPE
91627-7001	NONE	NONE		NONE	NONE	OPEN	NONE
91627-7501	NONE	NONE		CCT 1&2	NONE	OPEN	NONE
91627-7502	NONE	NONE		CCT 1&2 CCT 8&9	NONE	A	NONE
91627-7503	NONE	All		CCT 1&2 CCT 8&9	NONE	A	NONE
91627-7002	NONE	All		NONE	NONE	OPEN	NONE
91627-7504	NONE	NONE		CCT 1&2	CCT 3&4	OPEN	NONE
91627-7003	NONE	NONE		NONE	CCT 2&3	OPEN	NONE

12 CIRCUIT							
MOLEX PART NO.	TERMINAL VOID POSITION	REMOVED CODING KEYS	CONFIGURATION	LATCH BETWEEN	POLARIZING RIB BETWEEN	END WALLS	COLOUR STRIPE
91627-9501	NONE	NONE		NONE	NONE	OPEN	NONE
91627-9751	NONE	NONE		CCT 1&2	NONE	OPEN	NONE

NOTES:  
1. FIRST OKT SIDE IS THE SIDE CLOSEST TO OKT 1  
2. LAST OKT SIDE IS THE SIDE CLOSEST TO THE HIGHEST OKT SIDE

- DENOTES TERMINAL POSITION LOADED
- + DENOTES TERMINAL POSITION VOIDED
- DENOTES POSITION OF POLARISING RIB
- ⊞ DENOTES POSITION OF LOCKING LATCH

SEE SHEET 1 EC NO. E2010-0325 CHKD BY: BMAGUIRE APPR: BMAGUIRE 2010/05/28	QUALITY SYMBOLS ▽=0 ▽=0	GENERAL TOLERANCES (UNLESS SPECIFIED) mm INCH 4 PLACES ±--- ±--- 3 PLACES ±--- ±--- 2 PLACES ±0.10 ±--- 1 PLACE ±0.2 ±---	DIMENSION STYLE MM ONLY	SCALE 1:1	DESIGN UNITS METRIC	THIRD ANGLE PROJECTION
	APPROVED BY: DATE KIERMAN 07/05/2003		CHECKED BY: DATE BMAGUIRE 25/07/2003		APPROVED BY: DATE BMAGUIRE 2010/04/02	
	DRAFT WHERE APPLICABLE MUST REMAIN WITHIN DIMENSIONS		SEE CHARTS		MATERIAL NO. DOCUMENT NO.	
	INCORPORATED AND SHOULD NOT BE USED WITHOUT WRITTEN PERMISSION		SD-91627-001		SHEET NO. 3 OF 3	