

POWER RELAY

1 POLE—8A (65 A HIGH INRUSH CURRENT)

JS-KS SERIES

RoHS compliant

■ FEATURES

- Inrush current 65A, 1,000W, lamp load
- UL class B (130°C) coil wire insulation
- 1 form A (SPST-NO)
- Contact application 3 (CA 3)
- Low profile and space saving—Height: 12.5 mm
—Mounting space: 290 mm²
- High sensitivity in small package
—Operating power 110 to 140 mW
—Nominal power 220 to 290m W
- High isolation in small package
—Insulation distance : 8 mm (between coil and contacts)
—Dielectric strength : 5,000 VAC
—Surge strength : 10,000 V
- Plastic materials
—UL 94 flame class V-0
—UL CTI level class 2
- Plastic sealed type
- High current contact capacity
- RoHS compliant since date code: 0438B9, 0434R - Please see page 5 for more information

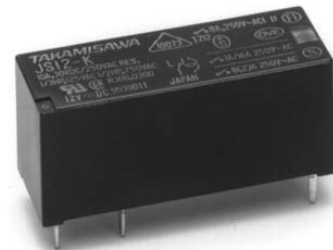

■ APPLICATIONS

- I/O module
- Timer
- HVAC

■ ORDERING INFORMATION

[Example] JS - 12 M N - K S
 (a) (*) (b) (c) (d) (e) (f)

(a)	Series Name	JS : JS Series
(b)	Nominal Voltage	Refer to the COIL DATA CHART
(c)	Contact Arrangement	M : 1 form A (SPST-NO)
(d)	Contact Material	N : AgSnO ₂ + Au 0.3μm
(e)	Enclosure	K : Plastic sealed type
(f)	Construction	S : 5.0 mm (lamp load 1,000W, 230 VAC, 25k operations))

Note: Actual marking omits the hyphen (-) of (*)

JS-KS SERIES

■ PART NUMBERS

Terminal pitch: 5.0mm

Order P/N	Series	Voltage	Contact Arrangement	Contact material	Enclosure	Terminal Pitch
JS-5M N-KS	JS	5	M: 1 form A	N: AgSnO ₂ + Au 0.3μm	K: Plastic Seal	S: 5.0 mm
JS-6M N-KS		6				
JS-9M N-KS		9				
JS-12M N-KS		12				
JS-18M N-KS		18				
JS-24M N-KS		24				
JS-48M N-KS		48				
JS-60M N-KS		60				

■ COIL DATA CHART

Coil voltage	Nominal voltage	Maximum voltage* ¹	Coil resistance (±10%)	Must operate voltage* ²	Must release voltage* ²	Nominal Power
5	5 VDC	11.8 VDC	112 Ω	3.5 VDC	0.5 VDC	225 mW
6	6 VDC	14.1 VDC	160 Ω	4.2 VDC	0.6 VDC	225 mW
9	9 VDC	21.2 VDC	360 Ω	6.3 VDC	0.9 VDC	225 mW
12	12 VDC	28.3 VDC	660 Ω	8.5 VDC	1.2 VDC	220 mW
18	18 VDC	42.4 VDC	1,455 Ω	12.7 VDC	1.8 VDC	225 mW
24	24 VDC	56.6 VDC	2,350 Ω	16.8 VDC	2.4 VDC	245 mW
48	48 VDC	105.6 VDC	8,000 Ω	33.4 VDC	4.8 VDC	290 mW
60	60 VDC	132.0 VDC	12,500 Ω	41.7 VDC	6.0 VDC	290 mW

Note : All values in the table are measured at 20°C.

*1: No contact current at 20°C.

*2: Specified values are subject to pulse wave voltage.

■ SPECIFICATIONS

Item		JS ()MN-KS	
Contact	Arrangement	1 Form A (SPST-NO)	
	Material	AgSnO ₂ +Au	
	Resistance (initial)	100m Ohm max., (1A 6VDC)	
	Rating	8A 250 VAC / 24 VDC	
	Max. carrying current	10A	
	Max. switching power	2,000 VA / 192 W	
	Max. switching voltage	400 VAC/ 150 VDC	
	Min. switching load*	100 mA 5 VDC	
Coil	Nominal power (at 20°C)	220 to 290 mW	
	Operate power (at 20°C)	110 to 140 mW	
	Operating temperature (at 20°C)	-40°C to +85°C (no frost)	
Time value	Operate	Max. 10 ms (at nominal voltage, without bounce)	
	Release (without diode)	Max. 5 ms (at nominal voltage, without bounce)	
Life	Mechanical	Min. 20x10 ⁶ operations	
	Electrical	AC rated load	Min. 100x10 ³ operations
		DC rated load	Min. 100x10 ³ operations
		Lamp load	1,000 W 25x10 ³ operations at 230VAC
Vibration resistance	Misoperation ≥1μs	10 to 55 Hz at double amplitude of 1.65 mm	
	Endurance ≥1μs	10 to 55 Hz at double amplitude of 3.3 mm	
Shock resistance	Misoperation	Min. 100 m/s ² (11±1 ms)	
	Endurance	Min. 1,000 m/s ² (6±1 ms)	
Weight		Approx. 8 g	

* Minimum switching loads mentioned above are reference values. Please perform the confirmation test with the actual load before production since reference values may vary according to switching frequencies, environmental conditions and expected reliability levels.

■ INSULATION

Items		
Resistive (at 5,000 VDC)		Min. 1,000 MΩ
Dielectric Strength	Open contacts	1,000 VAC (50/60 Hz) 1 min.
	Coil and contacts	5,000 VAC (50/60 Hz) 1 min.
Surge strength (coil and contacts)		10,000 V (1.2 x 50 μs standard wave)
Clearance / crepage		6 mm / 8 mm
Isolation (DIN EN 61810-1 VDE 0435)		
Voltage		250 V
Pollution		3
Isolation material group		III a
Isolation category / Reference voltage		C / 250V

JS-KS SERIES

SAFETY STANDARD (VDE 01106)

Type	Compliance	Contact rating
UL	UL 508 E 56140	Flammability: UL 94-V0 (plastics) 8 A 24 VDC (resistive) 100k operations 8 A 250 VAC (resistive) 100k operations Pilot duty: A300, R300
CSA	C22.2 No. 14 LR 35579	
VDE	0435, 0660, 40013847	AC: 15, 100x10 ³ DC: 13, 100x 10 ³

REFERENCE DATA

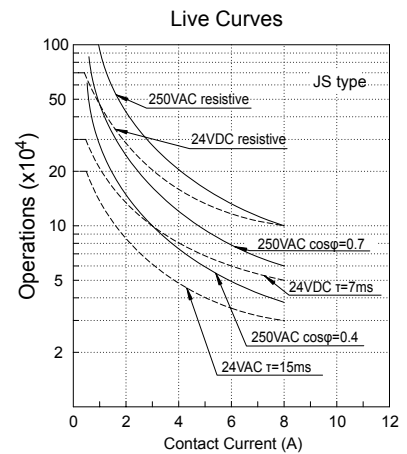
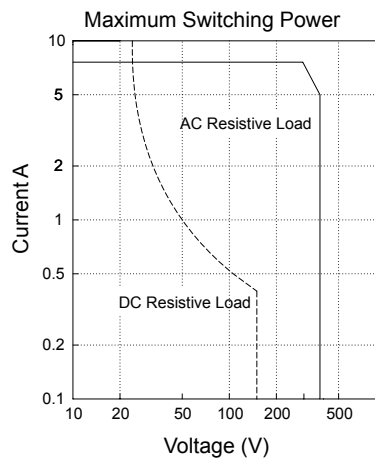
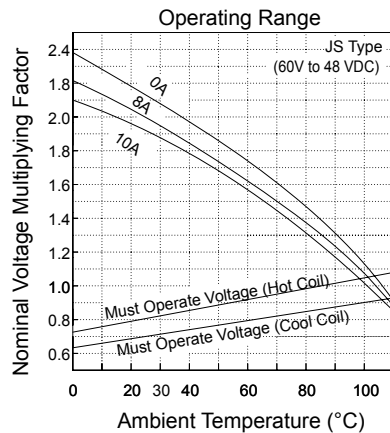
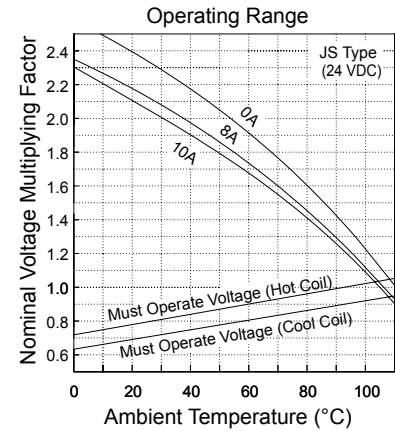
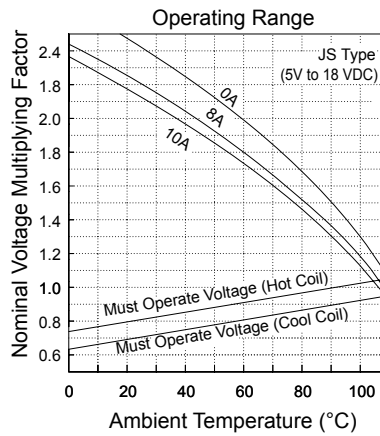
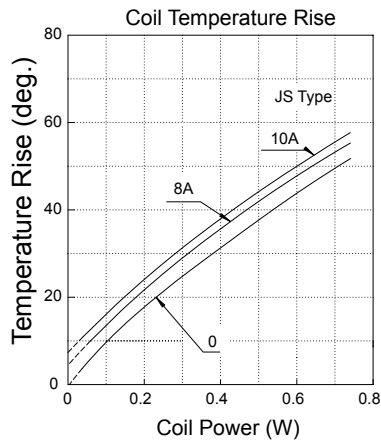

■ REFERENCE DATA

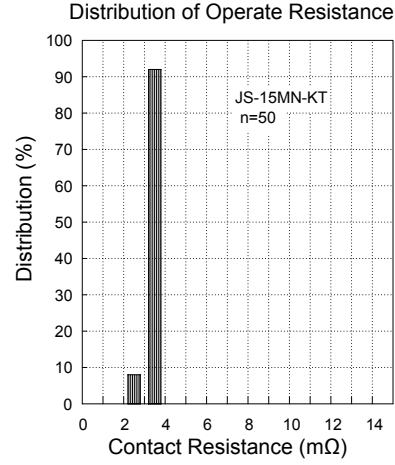
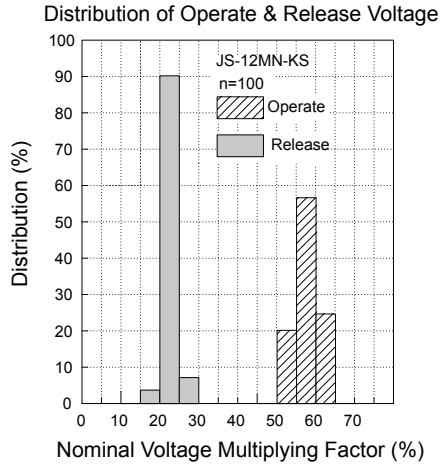

■ DIMENSIONS

● Dimensions

JS-MN-KS type

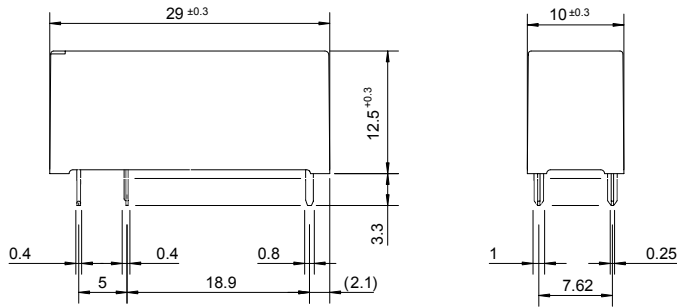

● Schematics

(BOTTOM VIEW)

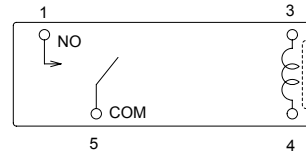

Unit: mm

● PC board mounting

hole layout
(BOTTOM VIEW)

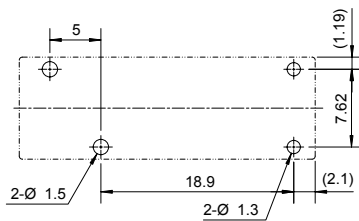

RoHS Compliance and Lead Free Relay Information

1. General Information

- Relays produced after the specific date code that is indicated on each data sheet are lead-free now. All of our signal and power relays are lead-free. Please refer to Lead-Free Status Info. (<http://www.fujitsu.com/us/downloads/MICRO/fcai/relays/lead-free-letter.pdf>)
- Lead free solder plating currently used in relays is Sn-3.0Ag-0.5Cu.
- All signal and power relays also comply with RoHS. Please refer to individual data sheets. Relays that are RoHS compliant do not contain the 5 hazardous materials above the threshold level that are restricted by RoHS directive (lead, mercury, chromium IV, PBB, PBDE).
- It has been verified that using lead-free relays in leaded assembly process will not cause any problems (compatible).
- "LF" is marked on each outer and inner carton. (No marking on individual relays).
- To avoid leaded relays (for lead-free sample, etc.) please consult with area sales office.

Note: Cadmium was exempted from RoHS on October 21, 2005. (Amendment to Directive 2002/95/EC)

2. Recommended Lead Free Solder Profile

- Recommended solder paste Sn-3.0Ag-0.5Cu.

Solder condition

Flow Solder condition:

Pre-heating: maximum 120°C
Soldering: dip within 5 sec. at
260°C solder bath

Solder by Soldering Iron:

Soldering Iron
Temperature: maximum 360°C
Duration: maximum 3 sec.

We highly recommend that you confirm your actual solder conditions

3. Moisture Sensitivity

- Moisture Sensitivity Level standard is not applicable to through hole electromechanical relays.

4. Tin Whisker

- Dipped SnAgCu solder is known as low risk tin whisker. No considerable length whisker was found by our in house test.

Fujitsu Components International Headquarter Offices

Japan

Fujitsu Component Limited
Gotanda-Chuo Building
3-5, Higashigotanda 2-chome, Shinagawa-ku
Tokyo 141, Japan
Tel: (81-3) 5449-7010
Fax: (81-3) 5449-2626
Email: promothq@ft.ed.fujitsu.com
Web: www.fcl.fujitsu.com

North and South America

Fujitsu Components America, Inc.
250 E. Caribbean Drive
Sunnyvale, CA 94089 U.S.A.
Tel: (1-408) 745-4900
Fax: (1-408) 745-4970
Email: components@us.fujitsu.com
Web: <http://www.fujitsu.com/us/services/edevices/components/>

Europe

Fujitsu Components Europe B.V.
Diamantlaan 25
2132 WV Hoofddorp
Netherlands
Tel: (31-23) 5560910
Fax: (31-23) 5560950
Email: info@fceu.fujitsu.com
Web: emea.fujitsu.com/components/

Asia Pacific

Fujitsu Components Asia Ltd.
102E Pasir Panjang Road
#01-01 Citilink Warehouse Complex
Singapore 118529
Tel: (65) 6375-8560
Fax: (65) 6273-3021
Email: fcal@fcal.fujitsu.com
Web: <http://www.fujitsu.com/sg/services/micro/components/>

©2008 Fujitsu Components America, Inc. All rights reserved. All trademarks or registered trademarks are the property of their respective owners.

Fujitsu Components America or its affiliates do not warrant that the content of datasheet is error free. In a continuing effort to improve our products Fujitsu Components America, Inc. or its affiliates reserve the right to change specifications/datasheets without prior notice.
Rev. July 23, 2008.