

PLEASE CHECK WWW.MOLEX.COM FOR LATEST PART INFORMATION

Part Number: [0496231295](#)
Status: **Active**
Description: 4.20mm (.165") Wire-to-Wire TPA™ Connector for Male Housing, 12 Circuits, UL94V-0, Ivory

Documents:

[Drawing \(PDF\)](#) [RoHS Certificate of Compliance \(PDF\)](#)
[Product Specification PS-49623-001 \(PDF\)](#)

Agency Certification

UL E29179

General

Product Family Crimp Housings
 Series [49623](#)
 Product Name N/A

Physical

Circuits (maximum) 12
 Circuits Detail 12
 Color - Resin Ivory
 Flammability 94V-0
 Gender Male
 Glow-Wire Compliant No
 Keying to Mating Part None
 Lock to Mating Part Yes
 Material - Resin Nylon
 Number of Rows 2
 Packaging Type Bag
 Panel Mount Yes
 Pitch - Mating Interface (in) 0.165 In
 Pitch - Mating Interface (mm) 4.20 mm
 Polarized to Mating Part Yes
 Stackable No
 Temperature Range - Operating -40°C to +105°C

Electrical

Current - Maximum per Contact 6A

Material Info

Reference - Drawing Numbers

Product Specification PS-49623-001
 Sales Drawing SD-49623-001

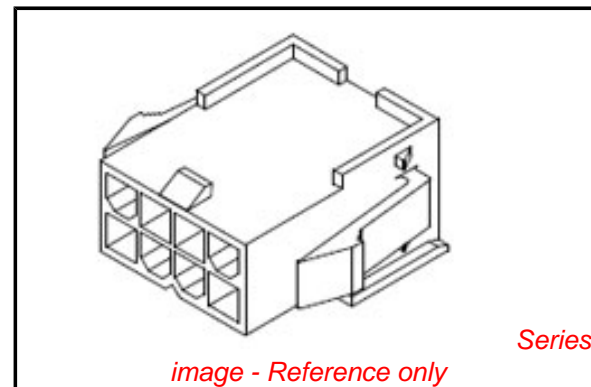

image - Reference only

EU RoHS

ELV and RoHS Compliant
REACH SVHC
Contains SVHC: No
Halogen-Free Status

China RoHS



Need more information on product environmental compliance?

Email productcompliance@molex.com
 For a multiple part number RoHS Certificate of Compliance, [click here](#)

Please visit the [Contact Us](#) section for any non-product compliance questions.

Search Parts in this Series

[49623Series](#)

Mates With

4.20mm (.165") Wire-to-Wire Female TPA™
[49624](#) , [49625](#) , [49626](#)

Use With

[5558](#) Mini-Fit® Crimp Terminal

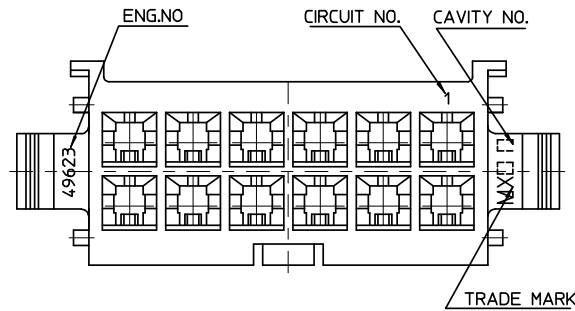

NOTES

- MATERIAL :
 - POLYAMID(PA66), UL94V-2, COLOR OF NATURAL
 - POLYAMID(PA66), UL94V-0, COLOR OF IVORY
- APPLICABLE TERMINAL · SERIES 5558 T2A, 5558 T
- MATE WITH : SERIES 49624, 49625, 49626
- PRODUCT SPECIFICATION · PS-49623-001
- PACKAGE SPECIFICATION : PK-49623-001
- PANEL HOLE TO BE PUNCHED OUT IN THE SAME DIRECTION AS INSERTION INTO THE PANEL

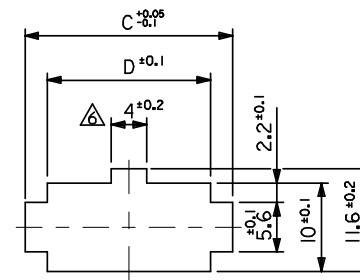

RECOMMENDED PANEL HOLE DIMENSION
(THICKNESS : 0.8-2.0mm)

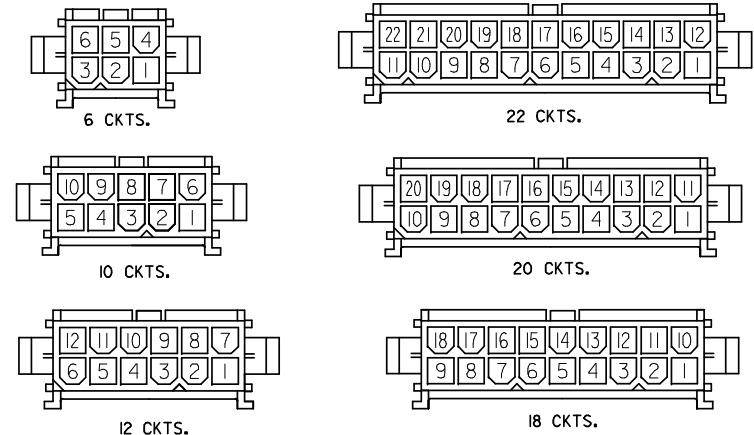
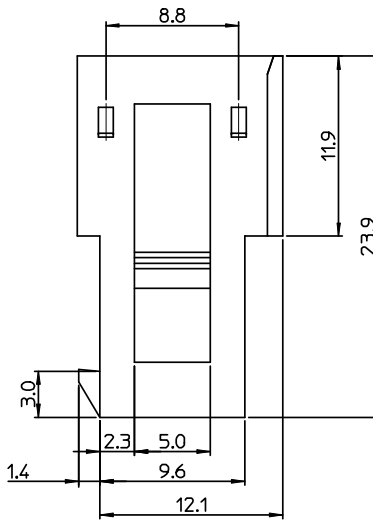
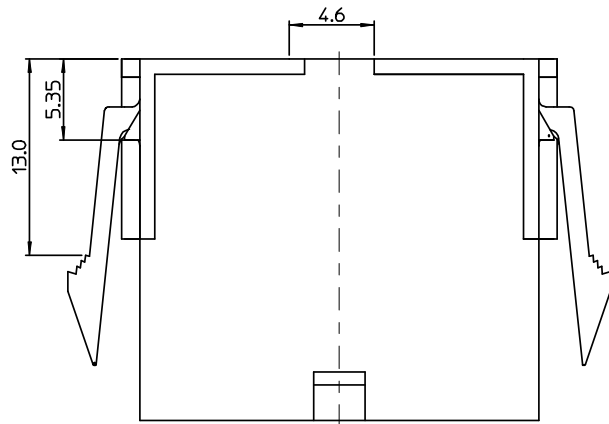
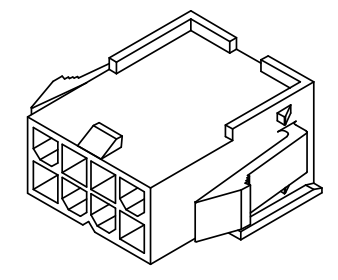

CIRCUIT SIZE LAYOUT

TABLE-1

49623-2295	496232295	49623-2290	496232290	22
49623-2095	496232095	49623-2090	496232090	20
49623-1895	496231895	49623-1890	496231890	18
49623-1295	496231295	49623-1290	496231290	12
49623-1095	496231095	49623-1090	496231090	10
49623-0695	496230695	49623-0690	496230690	06
ENG NO.	MATERIAL NO.	ENG NO.	MATERIAL NO.	CIRCUIT SIZE
POLYAMID(PA66), UL94V-0		POLYAMID(PA66), UL94V-2		

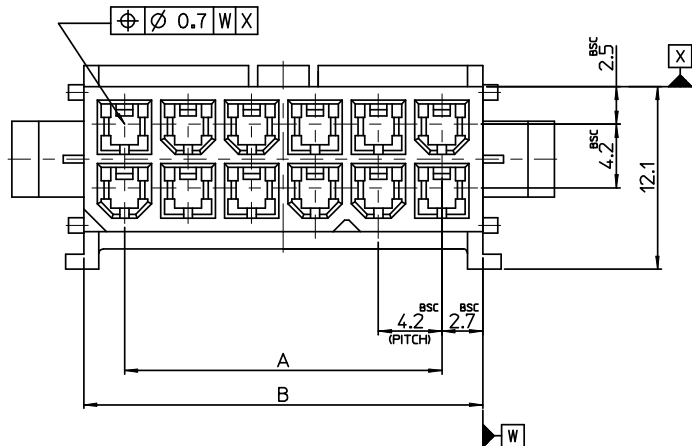

47.8	52.6	47.4	42	22
43.6	48.6	43.2	37.8	20
39.4	44.4	39	33.6	18
26.8	31.8	26.4	21	12
22.6	27.6	22.2	16.8	10
14.2	19.2	13.8	8.4	6
D	C	B	A	CIRCUIT

RELEASED	EC NO: KOR2008-0134	2008/02/27
DRAWN: SKHAN01	2008/02/27	
CHKD: WY YANG	2008/02/29	
APPR: YUNSIKKIM	2008/02/29	
REV	DESCRIPTION	

QUALITY SYMBOLS	GENERAL TOLERANCES (UNLESS SPECIFIED)
▽=0	mm INCH
▽=0	4 PLACES ± --- ± ---
	3 PLACES ± --- ± ---
	2 PLACES ± 0.3 ± ---
	1 PLACE ± 0.3 ± ---
	ANGULAR ± 3 °
	DRAFT WHERE APPLICABLE MUST REMAIN WITHIN DIMENSIONS

DIMENSION STYLE	
MM ONLY	
DRAWN BY	DATE
SK. HAN	2008/01/28
CHECKED BY	DATE
WY. YANG	2008/01/28
APPROVED BY	DATE
EH. JUNG	2008/01/28
MATERIAL NO.	
SEE TABLE	
SIZE	A2

SCALE	DESIGN UNITS	THIRD ANGLE PROJECTION
4:1	METRIC	☉ □
TITLE		
4.2MM W/W TPA CONN. FOR MALE HOUSING		
MATERIAL NO.		SHEET NO.
POLYAMID(PA66), UL94V-0		1 OF 1
DOCUMENT NO.		
MOLEX INCORPORATED		
SD-49623-001		
THIS DRAWING CONTAINS INFORMATION THAT IS PROPRIETARY TO MOLEX INCORPORATED AND SHOULD NOT BE USED WITHOUT WRITTEN PERMISSION		