

PLEASE CHECK WWW.MOLEX.COM FOR LATEST PART INFORMATION

Part Number: [0740266320](#)
Status: **Active**
Overview: [vhdm](#)
Description: 2.00mm (.079") Pitch VHDM® Board-to-Board Daughtercard Receptacle, Right Angle, 6-Row, 2 Blade Power Module, 1 Circuit

Documents:

[3D Model](#)
[Drawing \(PDF\)](#)

[RoHS Certificate of Compliance \(PDF\)](#)

General

Product Family	Backplane Connectors
Series	74026
Application	Daughtercard
Application Tooling Documents	Tooling Manual
Comments	Daughtercard Receptacle Module, Power, 2-Blade
Component Type	Power Receptacle
Overview	vhdm
Product Name	VHDM®
Style	N/A

Physical

Circuits (Loaded)	1
Circuits (maximum)	2
Color - Resin	Black
Durability (mating cycles max)	200
First Mate / Last Break	No
Guide to Mating Part	No
Keying to Mating Part	None
Material - Metal	High Performance Alloy (HPA)
Material - Plating Mating	Gold
Material - Plating Termination	Tin-Lead
Material - Resin	High Temperature Thermoplastic
Number of Columns	N/A
Number of Pairs	Open Pin Field
Number of Rows	6
Orientation	Right Angle
PCB Retention	None
PCB Thickness Recommended (in)	0.070 In
PCB Thickness Recommended (mm)	1.80 mm
Packaging Type	Tube
Pitch - Mating Interface (in)	0.079 In
Pitch - Mating Interface (mm)	2.00 mm
Plating min: Mating (µin)	30
Plating min: Mating (µm)	0.75
Plating min: Termination (µin)	35.2
Plating min: Termination (µm)	0.88
Polarized to PCB	Yes
Surface Mount Compatible (SMC)	Yes
Temperature Range - Operating	-55°C to +105°C
Termination Interface: Style	Through Hole - Compliant Pin

Electrical

Current - Maximum per Contact	10A
Data Rate	2.5 Gbps

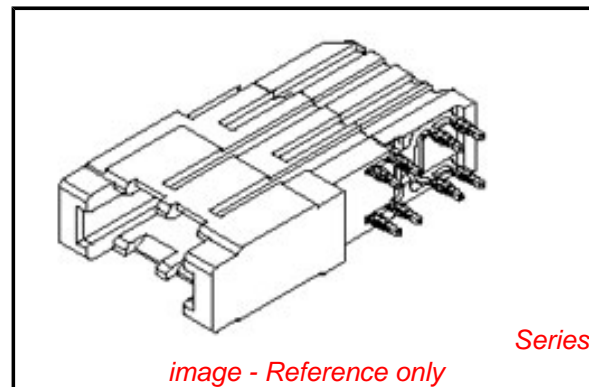

image - Reference only

EU RoHS

RoHS Compliant by Exemption

REACH SVHC

Contains SVHC: No

Halogen-Free

Status

Halogen-Free

China RoHS



Pb

Need more information on product environmental compliance?

Email productcompliance@molex.com
 For a multiple part number RoHS Certificate of Compliance, [click here](#)

Please visit the [Contact Us](#) section for any non-product compliance questions.

Search Parts in this Series

[74026Series](#)

Mates With

[74029 VHDM® Board-to-Board Backplane Receptacle Power Module](#)

Real Signals (per 25mm)	72
Voltage - Maximum	250V

Material Info

Reference - Drawing Numbers

Packaging Specification	PK-70873-200
Sales Drawing	SD-74026-001

VHDM and Very High Density Metric are trademarks of Amphenol Corporation

This document was generated on 05/19/2010

PLEASE CHECK WWW.MOLEX.COM FOR LATEST PART INFORMATION

MATERIAL NUMBER ASSIGNMENT

74026 - 6 * * 0 SEE NOTE 2. & 3.

BLADE 1 MATING LENGTH	BLADE 2 MATING LENGTH
1 = 7.5 mm	1 = 7.5 mm
2 = 9.0 mm	2 = 9.0 mm
3 = 10.5 mm	3 = 10.5 mm
4 = 12.0 mm	4 = 12.0 mm
6 = 7.5 mm	6 = 7.5 mm
7 = 9.0 mm	7 = 9.0 mm
8 = 10.5 mm	8 = 10.5 mm
9 = 12.0 mm	9 = 12.0 mm

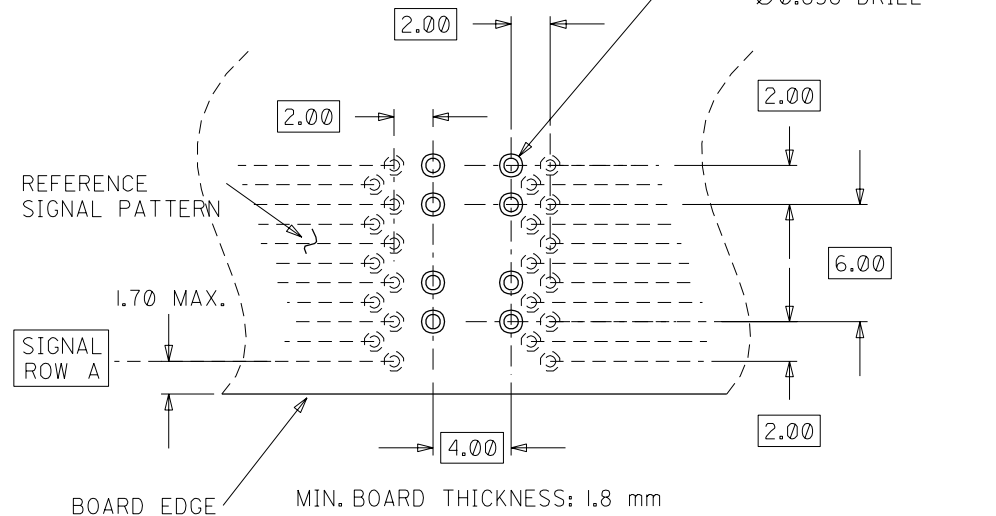
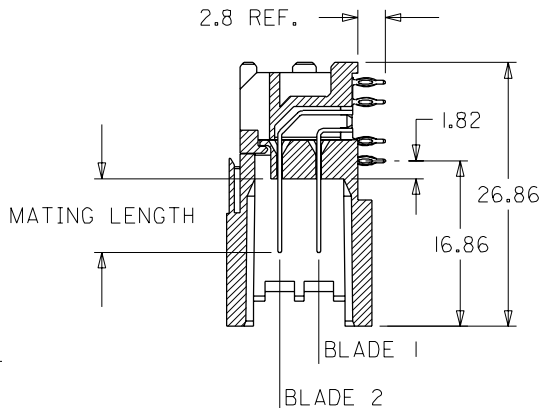
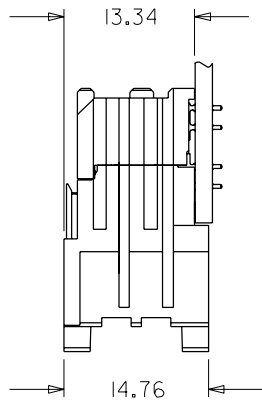
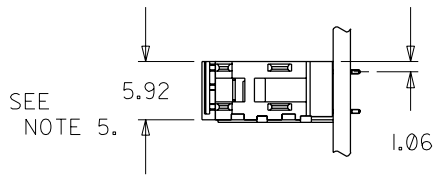
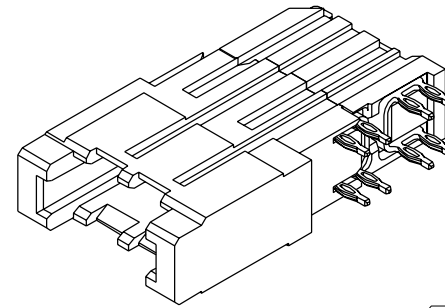

NOTES:

- MATERIALS:
HOUSING - LIQUID CRYSTAL POLYMER (LCP)
UL94 V-0 RATED, COLOR: BLACK
TERMINAL - COPPER ALLOY
- FINISH: SELECT GOLD ON MATING SURFACE, 30 microINCH THICK; TIN/LEAD ON TAILS; NICKEL OVERALL.
(WHEN * = 1, 2, 3, OR 4)
- FINISH: SELECT GOLD ON MATING SURFACE, 50 microINCH THICK; TIN/LEAD ON TAILS; NICKEL OVERALL.
(WHEN * = 6, 7, 8, OR 9)
- THIS PART CONFORMS TO PRODUCT SPECIFICATION PS-74031-999.
- PART SHOWN IS 74026-6110.
- USE 6.00 mm NOMINAL FOR DAUGHTERCARD LAYOUT.

ADD 50 GOLD P/N EC NO. UDT200-1-1333 DRWN: ELO 01/05/25 CHK: ELO 01/05/25 APPR: BIXLER 01/05/20	QUALITY SYMBOLS MAJOR $\nabla = 0$ CRITICAL $\nabla C = 0$	GENERAL TOLERANCES: (UNLESS SPECIFIED)		SCALE NONE	DESIGN UNITS <input checked="" type="checkbox"/> mm <input type="checkbox"/> INCH	DIMENSIONS:		SHT	REV
		mm	INCH	DRAWN BY & DATE ELO 98/10/15	THIRD ANGLE PROJECTION		REVISION ON CAD ONLY		
		4 PLACES ±0.	±.	CHECKED BY & DATE BREARLEY 98/10/21	TITLE: VHDM POWER 6 ROW DAUGHTERCARD SALES ASSEMBLY				
		3 PLACES ±0.	±.	APPROVED BY & DATE BIXLER 98/10/29	MOLEX INCORPORATED				
		2 PLACES ±0.	±.	CAD FILENAME	MATERIAL NO.	DRAWING NO.	SHEET NO.		SIZE
		1 PLACE ±0.	±.	SD-74026-001.S01	SEE CHART	SD-74026-001	1 OF 1		B
DRAFT WHERE APPLICABLE MUST REMAIN WITHIN DIMENSIONS		ANGULAR: ± 5 °		THIS DRAWING CONTAINS INFORMATION THAT IS PROPRIETARY TO MOLEX INCORPORATED AND SHOULD NOT BE USED WITHOUT WRITTEN PERMISSION.					