

ISOTOP[®] Buck chopper MOSFET Power Module

$V_{DSS} = 500V$
 $R_{DSon} = 65m\Omega \text{ Max @ } T_j = 25^\circ C$
 $I_D = 58A \text{ @ } T_c = 25^\circ C$

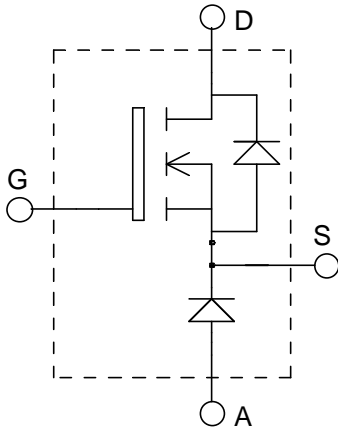

Application

- AC and DC motor control
- Switched Mode Power Supplies

Features

- Power MOS 8TM MOSFETs
 - Low R_{DSon}
 - Low input and Miller capacitance
 - Low gate charge
 - Avalanche energy rated
 - Very rugged
- ISOTOP[®] Package (SOT-227)
- Very low stray inductance
- High level of integration

Benefits

- Outstanding performance at high frequency operation
- Stable temperature behavior
- Very rugged
- Direct mounting to heatsink (isolated package)
- Low junction to case thermal resistance
- Easy paralleling due to positive TC of V_{CEsat}
- RoHS Compliant

Absolute maximum ratings

Symbol	Parameter	Max ratings	Unit
V_{DSS}	Drain - Source Breakdown Voltage	500	V
I_D	Continuous Drain Current	$T_c = 25^\circ C$	58
		$T_c = 80^\circ C$	43
I_{DM}	Pulsed Drain current	270	
V_{GS}	Gate - Source Voltage	± 30	V
R_{DSon}	Drain - Source ON Resistance	65	m Ω
P_D	Maximum Power Dissipation	$T_c = 25^\circ C$	543
I_{AR}	Avalanche current (repetitive and non repetitive)	42	A

CAUTION: These Devices are sensitive to Electrostatic Discharge. Proper Handling Procedures Should Be Followed. See application note APT0502 on www.microsemi.com

All ratings @ $T_j = 25^\circ\text{C}$ unless otherwise specified

Electrical Characteristics

Symbol	Characteristic	Test Conditions	Min	Typ	Max	Unit	
I_{DSS}	Zero Gate Voltage Drain Current	$V_{DS} = 500\text{V}$ $V_{GS} = 0\text{V}$	$T_j = 25^\circ\text{C}$			250	μA
			$T_j = 125^\circ\text{C}$			1000	
$R_{DS(on)}$	Drain – Source on Resistance	$V_{GS} = 10\text{V}, I_D = 42\text{A}$			65	$\text{m}\Omega$	
$V_{GS(th)}$	Gate Threshold Voltage	$V_{GS} = V_{DS}, I_D = 2.5\text{mA}$	3	4	5	V	
I_{GSS}	Gate – Source Leakage Current	$V_{GS} = \pm 30\text{V}$			± 100	nA	

Dynamic Characteristics

Symbol	Characteristic	Test Conditions	Min	Typ	Max	Unit
C_{iss}	Input Capacitance	$V_{GS} = 0\text{V}$ $V_{DS} = 25\text{V}$ $f = 1\text{MHz}$		10800		pF
C_{oss}	Output Capacitance			1164		
C_{rss}	Reverse Transfer Capacitance			148		
Q_g	Total gate Charge	$V_{GS} = 10\text{V}$ $V_{Bus} = 250\text{V}$ $I_D = 42\text{A}$		340		nC
Q_{gs}	Gate – Source Charge			75		
Q_{gd}	Gate – Drain Charge			155		
$T_{d(on)}$	Turn-on Delay Time	Resistive switching @ 25°C $V_{GS} = 15\text{V}$ $V_{Bus} = 333\text{V}$ $I_D = 42\text{A}$ $R_G = 2.2\Omega$		60		ns
T_r	Rise Time			70		
$T_{d(off)}$	Turn-off Delay Time			155		
T_f	Fall Time			50		

Chopper diode ratings and characteristics

Symbol	Characteristic	Test Conditions	Min	Typ	Max	Unit
V_{RRM}	Maximum Peak Repetitive Reverse Voltage		600			V
I_{RM}	Maximum Reverse Leakage Current	$V_R = 600\text{V}$	$T_j = 25^\circ\text{C}$		25	μA
			$T_j = 125^\circ\text{C}$		500	
I_F	DC Forward Current	$T_c = 90^\circ\text{C}$		30		A
V_F	Diode Forward Voltage	$I_F = 30\text{A}$		1.8	2.2	V
		$I_F = 60\text{A}$		2.2		
		$I_F = 30\text{A}$	$T_j = 125^\circ\text{C}$	1.5		
t_{rr}	Reverse Recovery Time	$I_F = 30\text{A}$ $V_R = 400\text{V}$ $di/dt = 200\text{A}/\mu\text{s}$	$T_j = 25^\circ\text{C}$	25		ns
			$T_j = 125^\circ\text{C}$	160		
Q_{rr}	Reverse Recovery Charge	$I_F = 30\text{A}$ $V_R = 400\text{V}$ $di/dt = 200\text{A}/\mu\text{s}$	$T_j = 25^\circ\text{C}$	35		nC
			$T_j = 125^\circ\text{C}$	480		

Thermal and package characteristics

Symbol	Characteristic	Min	Typ	Max	Unit
R_{thJC}	Junction to Case Thermal Resistance	Mosfet		0.23	$^\circ\text{C}/\text{W}$
		Diode		1.05	
R_{thJA}	Junction to Ambient (IGBT & Diode)			20	$^\circ\text{C}/\text{W}$
V_{ISOL}	RMS Isolation Voltage, any terminal to case $t = 1\text{ min}, I_{isol} < 1\text{mA}, 50/60\text{Hz}$	2500			V
T_j, T_{STG}	Storage Temperature Range	-40		150	$^\circ\text{C}$
T_L	Max Lead Temp for Soldering: 0.063" from case for 10 sec			300	
Torque	Mounting torque (Mounting = 8-32 or 4mm Machine and terminals = 4mm Machine)			1.5	N.m
Wt	Package Weight		29.2		g

SOT-227 (ISOTOP[®]) Package Outline

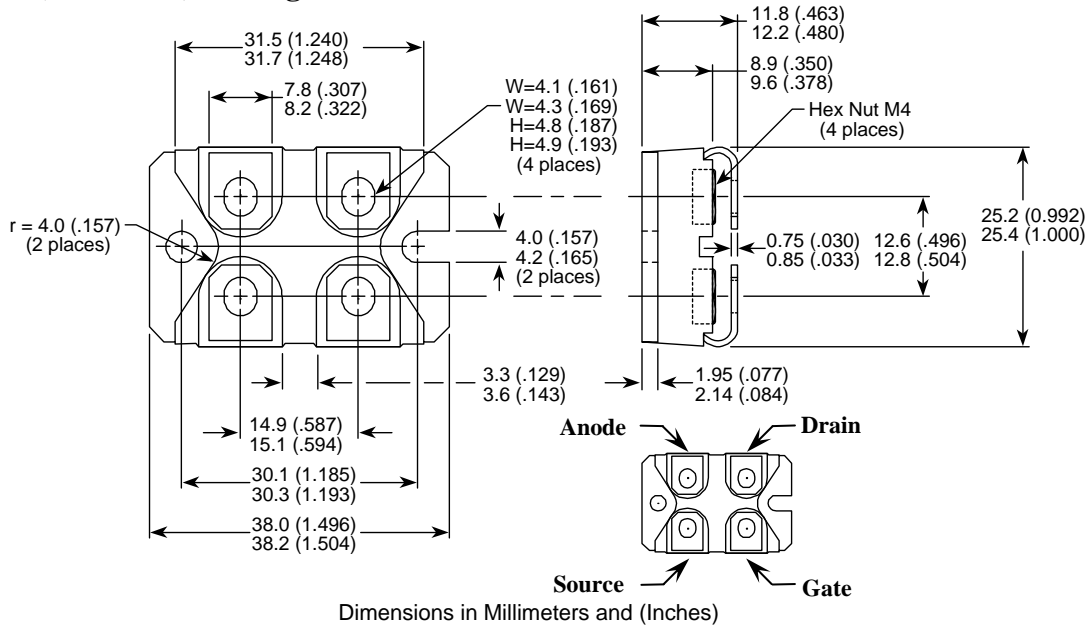

Typical Mosfet Performance Curve

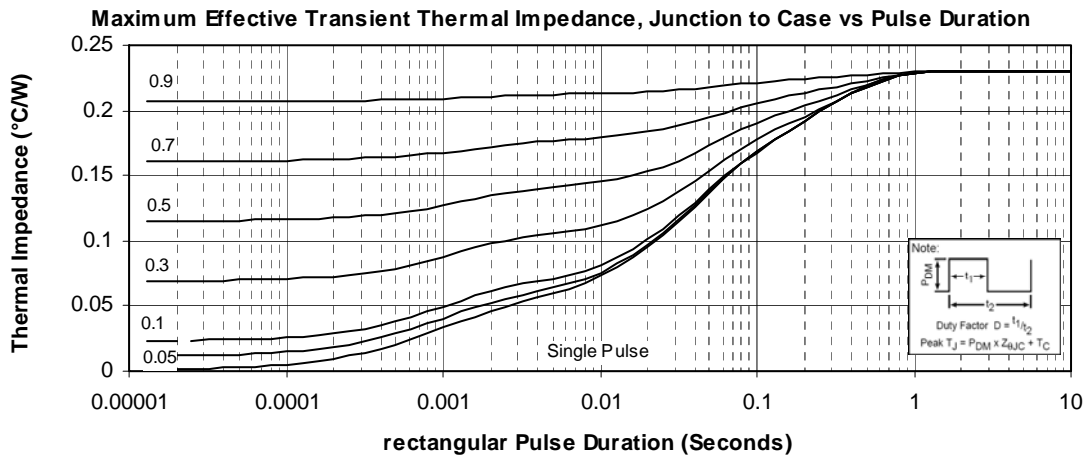

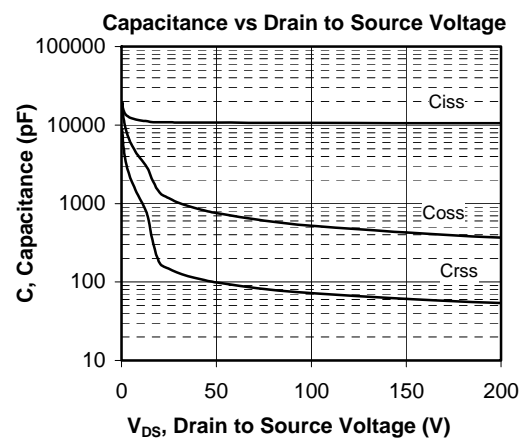
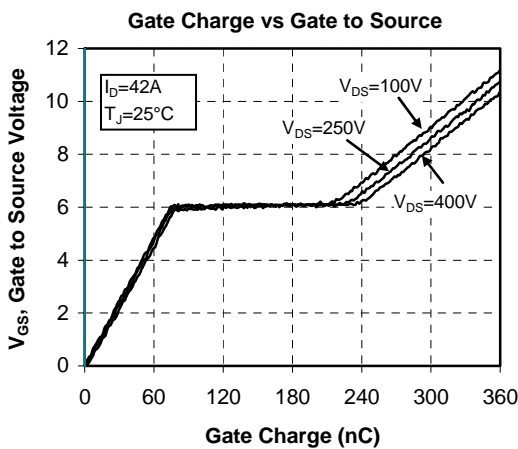
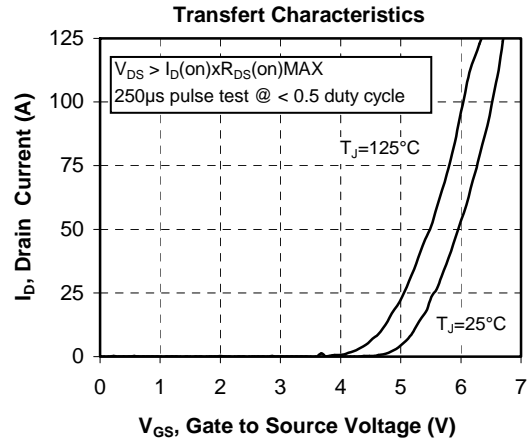
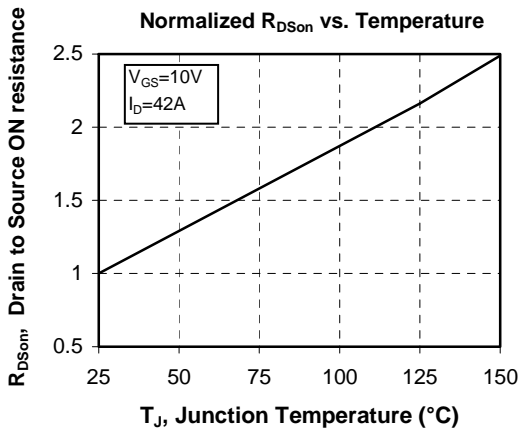
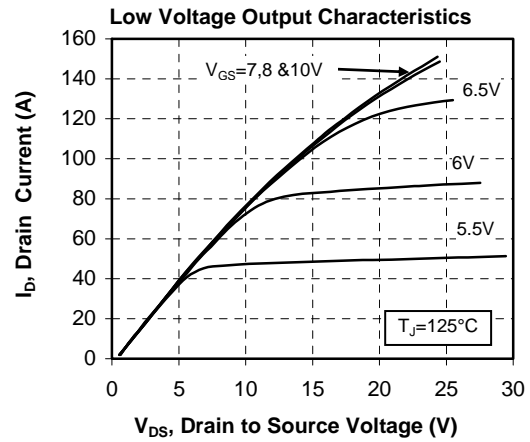
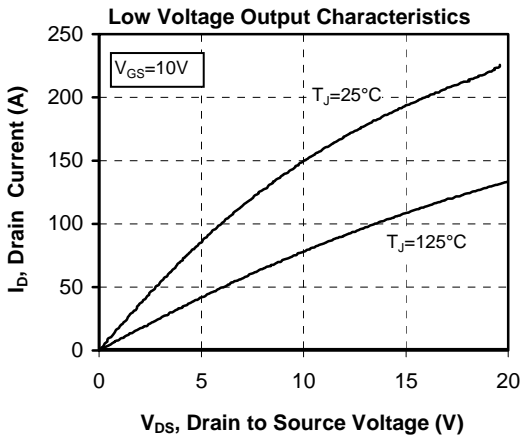

Typical Diode Performance Curve

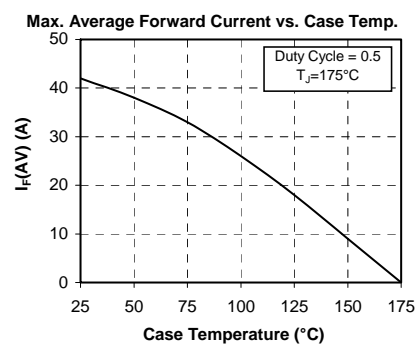
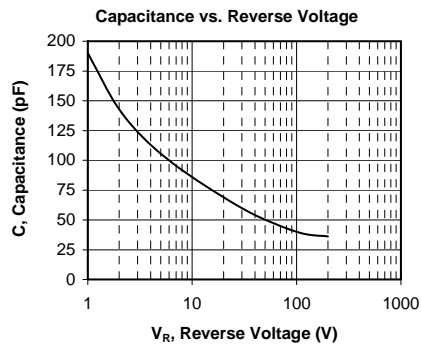
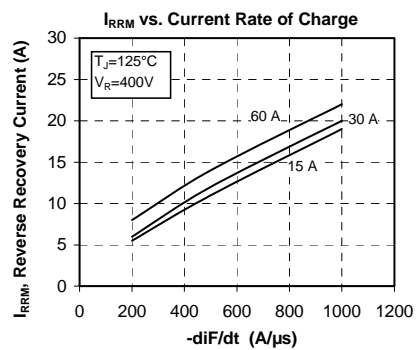
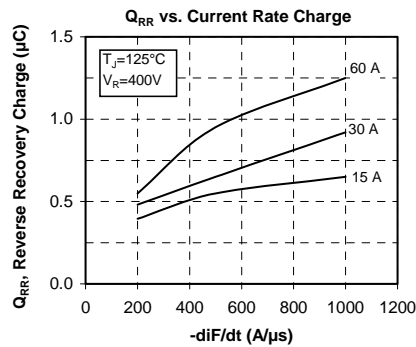
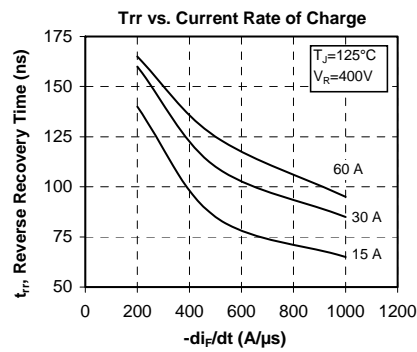
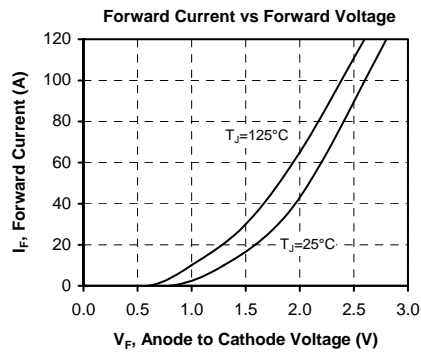
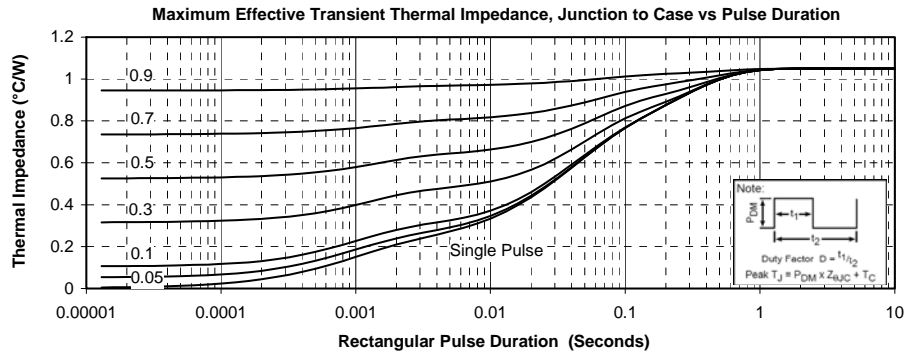

ISOTOP® is a registered trademark of ST Microelectronics NV

Microsemi reserves the right to change, without notice, the specifications and information contained herein

Microsemi's products are covered by one or more of U.S. patents 4,895,810 5,045,903 5,089,434 5,182,234 5,019,522 5,262,336 6,503,786 5,256,583 4,748,103 5,283,202 5,231,474 5,434,095 5,528,058 and foreign patents. U.S and Foreign patents pending. All Rights Reserved.