

**PLEASE CHECK WWW.MOLEX.COM FOR LATEST PART INFORMATION**

**Part Number:** [0340813003](#)  
**Status:** **Active**  
**Overview:** [mx150 sealed connector system](#)  
**Description:** MX150™ Female Cable Seal Terminal, Gold (Au) Plating, 14-16 AWG, Left Reel Payoff, Contact Material Thickness 0.30mm (.012")

**Documents:**

[Drawing \(PDF\)](#) [RoHS Certificate of Compliance \(PDF\)](#)

**General**

Product Family	Crimp Terminals
Series	<a href="#">34081</a>
Comments	Left Reel Payoff, Cable Seal
Crimp Quality Equipment	Yes
Overview	<a href="#">mx150 sealed connector system</a>
Product Name	MX150™

**Physical**

Gender	Female
Material - Metal	High Performance Alloy (HPA)
Material - Plating Mating	Gold
Material - Plating Termination	Tin
Packaging Type	Reel
Plating min: Mating (µin)	30.4
Plating min: Mating (µm)	0.76
Plating min: Termination (µin)	100
Plating min: Termination (µm)	2.5
Termination Interface: Style	Crimp or Compression
Wire Insulation Diameter	2.60mm (.102") max.
Wire Size AWG	14, 16
Wire Size mm²	1.5

**Electrical**

Current - Maximum per Contact	22A
Voltage - Maximum	250V

**Material Info**

**Reference - Drawing Numbers**

Sales Drawing	SD-34083-002
---------------	--------------

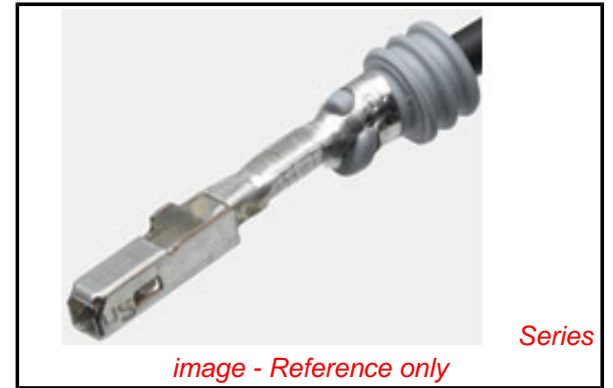

**EU RoHS**

**ELV and RoHS Compliant**  
**REACH SVHC Contains SVHC: No**  
**Halogen-Free Status**

**China RoHS**



**Need more information on product environmental compliance?**

Email [productcompliance@molex.com](mailto:productcompliance@molex.com)  
 For a multiple part number RoHS Certificate of Compliance, [click here](#)

Please visit the [Contact Us](#) section for any non-product compliance questions.

**Search Parts in this Series**

[34081Series](#)

**Use With**

[33471](#) Single Row Sealed Connector, [33472](#) Dual Row Sealed Connector, [33476](#) Dual Row Hybrid Sealed Connector, [34062](#) Single Row 2-Way Cable Sealed Connector, [34250](#) Single Row 3-Way Cable Sealed Connector

**Application Tooling | FAQ**

*Tooling specifications and manuals are found by selecting the products below. Crimp Height Specifications are then contained in the Application Tooling Specification document.*

**Global**

Description	Product #
Manual Extraction Tool	<a href="#">0638131500</a>
Hand Crimp Tool For MX150 Cable Seal Crimp Terminals	<a href="#">0638199000</a>

Hand Crimp Tool For 0638199100  
MX150 Cable Seal  
Crimp Terminals  
Fine Adjust 0639018000  
Applicator for  
MX150™ Cable Seal  
Crimp Terminals

This document was generated on 05/19/2010

**PLEASE CHECK [WWW.MOLEX.COM](http://WWW.MOLEX.COM) FOR LATEST PART INFORMATION**

STAMP PLATING TYPE (Au-GOLD),  
(Sn-TIN) OR (Ag-SILVER) IN THIS AREA

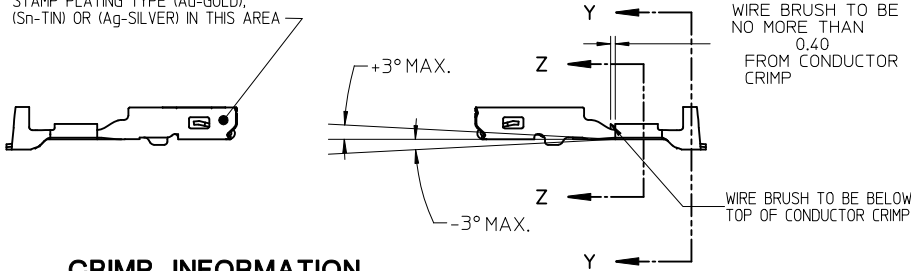

**CRIMP INFORMATION**  
SEE TABLE 1 ON SHEET 2

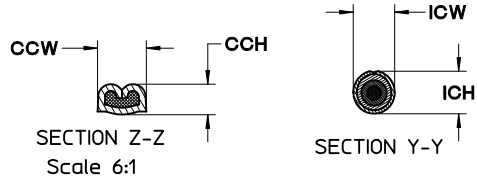

SILVER PLATING:  
BASE LAYER:  
ELECTRODEPOSITED DUCTILE SULFATE NICKEL  
THICKNESS: 1.25 - 2.25 MICROMETERS

SILVER LAYER:  
ZONE A1 AND ZONE A2  
ELECTRODEPOSITED PURE SILVER (IMPURITIES 0.5% MAX)  
FINISH: SEMI-BRIGHT  
THICKNESS: 1.9 - 3.3 MICROMETERS

ANTI-TARNISH TREATMENT FOR SILVER PLATED TERMINALS:  
EVABRITE WS

ZONE B:  
TIN PLATING: PER MOLEX ES-88 REVISION: REL

THICKNESS 1 (1.25 - 2.25 MICROMETERS)  
ELECTRODEPOSITED SULFAMATE DUCTILE NICKEL (BASE LAYER)

THICKNESS 2 (2.50 - 4.00 MICROMETERS) ELECTRODEPOSITED  
TIN (100% TIN) MATTE FINISH

PLATING NOTES:

1. TIN PLATING: (ENTIRE TERMINAL)

THICKNESS 1 (0.25-1.00 MICROMETERS)  
ELECTRODEPOSITED ADVANCED TIN BARRIER (BASE LAYER)

THICKNESS 2 (0.50-1.00 MICROMETERS)  
ELECTRODEPOSITED REFLOW TIN (100% TIN, NO BRIGHTENERS)

**PLATING INFORMATION**

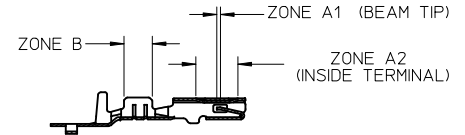

SECTION A-A

GOLD PLATING NOTES:

ZONE A1 AND ZONE A2:  
PER MOLEX ES-88 REVISION:REL

THICKNESS 1 (1.25 - 2.25 MICROMETERS)  
ELECTRODEPOSITED SULFAMATE DUCTILE NICKEL (BASE LAYER)

THICKNESS 2 (0.76 MICROMETERS MINIMUM)  
ELECTRODEPOSITED GOLD CAP

ZONE B:  
TIN PLATING: PER MOLEX ES-88 REVISION:REL

THICKNESS 1 (1.25-2.25 MICROMETERS)  
ELECTRODEPOSITED SULFAMATE DUCTILE NICKEL (BASE LAYER)

THICKNESS 2 (2.50 - 4.00 MICROMETERS) ELECTRODEPOSITED  
TIN (100% TIN) MATTE FINISH

NOTES: (UNLESS OTHERWISE SPECIFIED)

- MATING TERMINAL SHOWN ON MOLEX DRAWING SD-34080-001
- MATERIAL: ASTM B422, UNS C19025, HR04  
THICKNESS: 0.30 mm +0.01  
TEMPER: FULL HARD (REF)  
TENSILE: 496 MIN MPA  
PLATING: SEE PLATING NOTES
- MEETS PERFORMANCE SPECIFICATION FOR CABLE TO TERMINAL  
ELECTRICAL CRIMPS PER SAE/USCAR-21 (8/2001)
- MEETS PERFORMANCE STANDARD FOR AUTOMOTIVE ELECTRICAL  
CONNECTOR SYSTEMS FOR SAE/USCAR-2, REV. 4 (TEMP CLASS 3)  
(4/2001)
- MEETS ELECTRICAL CONNECTION SYSTEM DESIGN SPECIFICATION  
(SDS) REV.11 (5/2002)
- MEETS FIELD CORRELATED LIFE TEST (FCLT) PER  
SAE/USCAR-20 (11/2001)

- INSERTION FORCE WITH INLINE BLADE  
AVG FROM PV TESTING = 3.5 N TIN (REFERENCE)  
3.1 N GOLD (REFERENCE)
- REFERENCE PK-31300-516 FOR REEL DIRECTION
- REFERENCE CS-34083-002 FOR ADDITIONAL  
CRIMP INFORMATION

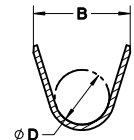

SECTION B-B  
Scale 5:1

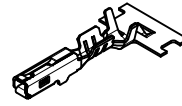
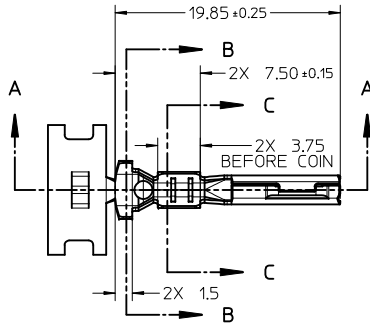

SCALE 2:1

SEE TABLE 2 ON SHEET 3  
FOR CHARTED DIM.

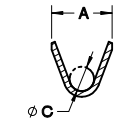

SECTION C-C  
Scale 5:1

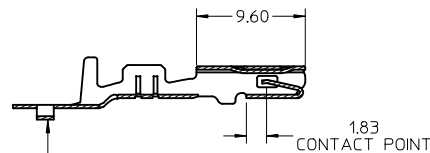

SECTION A-A

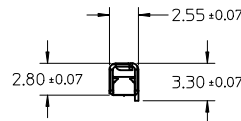

CARRIER BUMP DIRECTION  
POINTS DOWN FOR TIN PLATED TERMINALS  
POINTS UP FOR PRECIOUS PLATED TERMINALS

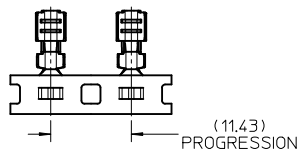

<b>ENTER DESCRIPTION</b> IEC NO: UAU2010-0419 DRW:KFERGUSON CHK: A. DHIR APPR: B. MOSER 2009/12/02 2009/12/02	QUALITY SYMBOLS ▽=0 ▽=0	GENERAL TOLERANCES (UNLESS SPECIFIED)	DIMENSION STYLE MM ONLY	SCALE 3:1	DESIGN UNITS METRIC	THIRD ANGLE PROJECTION
	mm INCH	DRAWN BY DATE K. FERGUSON 4/14/2009	CHECKED BY DATE A. DHIR 4/14/2009	APPROVED BY DATE B. MOSER 4/14/2009	MOLEX INCORPORATED	
	DRAFT WHERE APPLICABLE MUST REMAIN WITHIN DIMENSIONS	MATERIAL NO. SEE TABLE	DOCUMENT NO. SD-34083-002	SHEET NO. 1 OF 3		
	THIS DRAWING CONTAINS INFORMATION THAT IS PROPRIETARY TO MOLEX INCORPORATED AND SHOULD NOT BE USED WITHOUT WRITTEN PERMISSION					

**TABLE 1 – TERMINAL CRIMP DIMENSION REFERENCE TABLE**

SUPPLIER PART NO.	PLATING	WIRE SIZE (awg)	WIRE SPECIFICATION	CONDUCTOR CCH (SEC Z-Z) ±0.05	CONDUCTOR CCW (SEC Z-Z) ±0.10	INSULATOR ICH (SEC Y-Y) ±0.10	INSULATOR ICW (SEC Y-Y) ±0.10	WIRE PULL FORCE (N)	OSR CABLE SEAL PART NO.	YAZAKI CABLE SEAL PART NO.	
RIGHT PAYOFF	LEFT PAYOFF										
34083-2001	34083-3001	TIN	14	MIL-123A	1.65	2.45	3.95	3.65	268	-	7158-3033-40
			14	MIL-135A1	1.65	2.45	3.80	3.65	268	E-1644-02	-
			16	MIL-123A	1.35	2.45	3.80	3.65	222	E-1644-02	-
34083-2002	34083-3002	TIN	18	MIL-123A	1.25	2.15	3.70	3.55	157	E-1644-00	-
			18	SAE J1128 (GXL)	1.25	2.15	3.90	3.55	157	E-1644-02	-
			20	MIL-123A	1.15	2.15	3.60	3.55	128	E-1644-00	-
			20	SAE J1128 (GXL)	1.15	2.15	3.80	3.55	128	E-1644-02	-
34083-2003	34083-3003	TIN	22	MIL-123A	1.00	1.60	3.50	3.45	88	E-1644-01	-
34083-2001	34083-3001	TIN	2.00mm <sup>2</sup>	JASO D 611(AVSS)	1.60	2.45	3.95	3.65	268	-	7158-3033-40
34083-2001	34083-3001	TIN	1.50mm <sup>2</sup>	MIL-126A1	1.40	2.45	3.80	3.65	257	E-1644-02	-
34083-2002	34083-3002	TIN	1.0mm <sup>2</sup>	MIL-126A1	1.30	2.15	3.70	3.55	211	E-1644-00	-
34083-2002	34083-3002	TIN	0.75mm <sup>2</sup>	MIL-126A1	1.25	2.15	3.60	3.55	142	E-1644-00	-
34083-2003	34083-3003	TIN	0.50mm <sup>2</sup>	MIL-126A1	1.10	1.60	3.50	3.45	111	E-1644-01	-
34083-2003	34083-3003	TIN	0.50mm <sup>2</sup>	JASO D 611(AVSS)	1.10	1.60	3.50	3.45	111	E-1644-01	-
34081-2003	34081-3003	GOLD	14	MIL-123A	1.65	2.45	3.95	3.65	268	-	7158-3033-40
			14	MIL-135A1	1.65	2.45	3.80	3.65	268	E-1644-02	-
			16	MIL-123A	1.35	2.45	3.80	3.65	222	E-1644-02	-
34081-2004	34081-3004	GOLD	18	MIL-123A	1.25	2.15	3.70	3.55	157	E-1644-00	-
			18	SAE J1128 (GXL)	1.25	2.15	3.90	3.55	157	E-1644-02	-
			20	MIL-123A	1.15	2.15	3.60	3.55	128	E-1644-00	-
			20	SAE J1128 (GXL)	1.15	2.15	3.80	3.55	128	E-1644-02	-
34081-2005	34081-3005	GOLD	22	MIL-123A	1.00	1.60	3.50	3.45	88	E-1644-01	-
34081-2003	34081-3003	GOLD	2.00mm <sup>2</sup>	JASO D 611(AVSS)	1.60	2.45	3.95	3.65	268	-	7158-3033-40
34081-2003	34081-3003	GOLD	1.50mm <sup>2</sup>	MIL-126A1	1.40	2.45	3.80	3.65	257	E-1644-02	-
34081-2004	34081-3004	GOLD	1.0mm <sup>2</sup>	MIL-126A1	1.30	2.15	3.70	3.55	211	E-1644-00	-
			0.75mm <sup>2</sup>	MIL-126A1	1.25	2.15	3.60	3.55	142	E-1644-00	-
			0.50mm <sup>2</sup>	MIL-126A1	1.10	1.60	3.50	3.45	111	E-1644-01	-
34081-2005	34081-3005	GOLD	0.50mm <sup>2</sup>	JASO D 611(AVSS)	1.10	1.60	3.50	3.45	111	E-1644-01	-
34081-4001	34081-5001	SILVER	14	MIL-123A	1.65	2.45	3.95	3.65	268	-	7158-3033-40
			14	MIL-135A1	1.65	2.45	3.80	3.65	268	E-1644-02	-
			16	MIL-123A	1.35	2.45	3.80	3.65	222	E-1644-02	-
34081-4002	34081-5002	SILVER	18	MIL-123A	1.25	2.15	3.70	3.55	157	E-1644-00	-
			18	SAE J1128 (GXL)	1.25	2.15	3.90	3.55	157	E-1644-02	-
			20	MIL-123A	1.15	2.15	3.60	3.55	128	E-1644-00	-
			20	SAE J1128 (GXL)	1.15	2.15	3.80	3.55	128	E-1644-02	-
34081-4003	34081-5003	SILVER	22	MIL-123A	1.00	1.60	3.50	3.45	88	E-1644-01	-
34081-4001	34081-5001	SILVER	2.00mm <sup>2</sup>	JASO D 611(AVSS)	1.60	2.45	3.95	3.65	268	-	7158-3033-40
34081-4001	34081-5001	SILVER	1.50mm <sup>2</sup>	MIL-126A1	1.40	2.45	3.80	3.65	257	E-1644-02	-
34081-4002	34081-5002	SILVER	1.0mm <sup>2</sup>	MIL-126A1	1.30	2.15	3.70	3.55	211	E-1644-00	-
			0.75mm <sup>2</sup>	MIL-126A1	1.25	2.15	3.60	3.55	142	E-1644-00	-
			0.50mm <sup>2</sup>	MIL-126A1	1.10	1.60	3.50	3.45	111	E-1644-01	-
34081-4003	34081-5003	SILVER	0.50mm <sup>2</sup>	JASO D 611(AVSS)	1.10	1.60	3.50	3.45	111	E-1644-01	-

<b>ENTER DESCRIPTION</b> IEC NO. UAU2010-0419 DRAWN BY K. FERGUSON CHECKED BY CHIKKA, DHIR APPROVED BY B. MOSER DATE 2009/12/02 REV 01	<b>QUALITY SYMBOLS</b> ▽=0 ▽=0	GENERAL TOLERANCES (UNLESS SPECIFIED): DIMENSION STYLE: <b>MM ONLY</b>		SCALE: <b>METRIC</b>	DESIGN UNITS: <b>METRIC</b>	THIRD ANGLE PROJECTION		
		4 PLACES ± 0.10 3 PLACES ± 0.15 2 PLACES ± 0.20 1 PLACE ± 0.30	INCH ± 0.005 ± 0.010 ± 0.020 ± 0.050	DRAWN BY: K. FERGUSON CHECKED BY: A. DHIR APPROVED BY: B. MOSER DATE: 4/14/2009	DATE: 4/14/2009	<b>MX 150 RECEPTACLE CABLE SEAL</b>		
		DRAFT WHERE APPLICABLE MUST REMAIN WITHIN DIMENSIONS		MATERIAL NO. <b>SEE TABLE</b>	DOCUMENT NO. <b>SD-34083-002</b>	<b>MOLEX INCORPORATED</b>		
		SIZE <b>D</b>		THIS DRAWING CONTAINS INFORMATION THAT IS PROPRIETARY TO MOLEX INCORPORATED AND SHOULD NOT BE USED WITHOUT WRITTEN PERMISSION				

**CRIMP TOOL INFORMATION**  
SEE TABLE 2 FOR TABLED DIMENSIONS

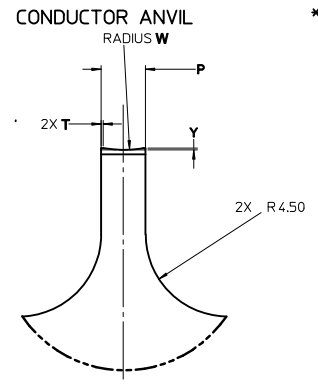
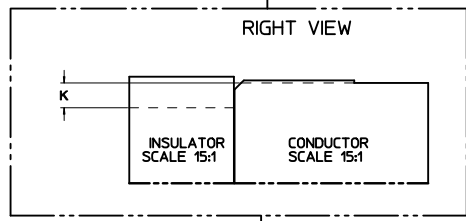
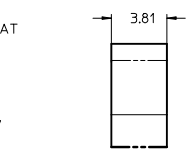
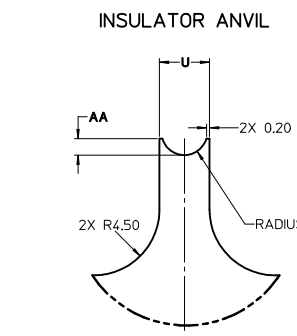
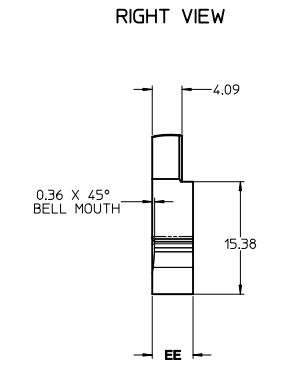
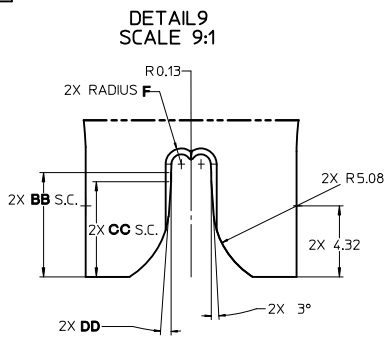
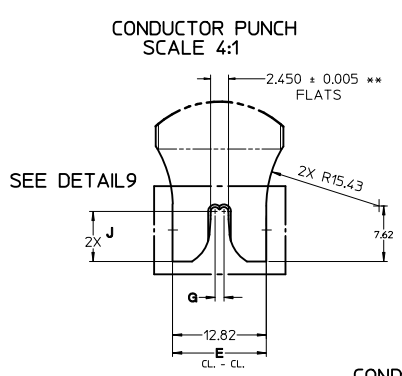
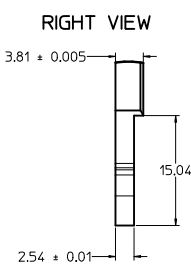
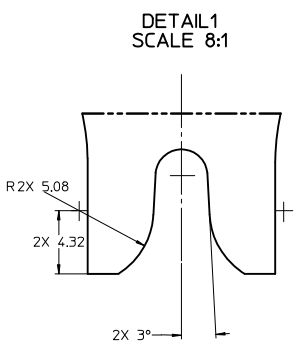
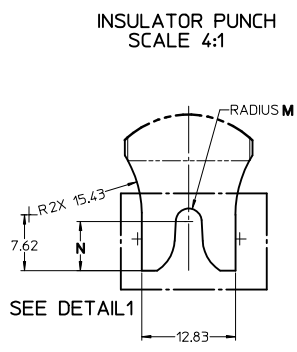

\*\* 14-16 AWG, 150mm<sup>2</sup> & 2.0mm<sup>2</sup> ONLY

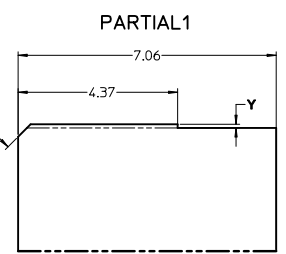

**TABLE 2 - TERMINAL GRIP/CRIMP TOOL DIMENSION REFERENCE TABLE**

SUPPLIER PART NUMBER		PLATING (STAMPING)	WIRE APPLICATION		A	B	C	D	E	F	G	J	K	M	N	P	T	U	V	W	Y	AA	BB	CC	DD	EE
RIGHT PAYOFF	LEFT PAYOFF		SAE (AWG)	METRIC (mm <sup>2</sup> )	+0.3	+0.20	+0.3	+0.15	+0.01	+0.005	+0.005	+0.05	+0.01	+0.005	+0.10	+0.005	+0.03	+0.005	+0.005	+0.10	+0.01	+0.10	+0.01	+0.01	+0.01	±P
34083-2001	34083-3001	TIN	14	2.0	3.6	5.00	1.7	2.90	12.82	0.600	1.194	6.86	0.90	1.778	6.73	2.438	0.12	3.429	1.575	6.11	0.10	1.13	6.34	5.79	4°	5.59
			16	1.5	3.6	5.00	1.7	2.90	12.82	0.600	1.194	6.86	0.90	1.778	6.73	2.438	0.12	3.429	1.575	6.11	0.10	1.13	6.34	5.79	4°	5.59
34083-2002	34083-3002	TIN	18	1.0	3.3	5.00	1.3	2.90	12.57	0.556	0.963	7.34	0.70	1.753	6.73	2.085	0.33	3.378	1.699	1.94	0.14	0.88	-	-	-	3.81
			20	0.75	3.3	5.00	1.3	2.90	12.57	0.556	0.963	7.34	0.70	1.753	6.73	2.085	0.33	3.378	1.699	1.94	0.14	0.88	-	-	-	3.81
34083-2003	34083-3003	TIN	22	0.5	2.5	4.85	0.9	2.90	11.92	0.414	0.714	6.27	0.55	1.737	7.06	1.576	0.26	3.327	1.524	2.00	0.07	1.08	-	-	-	3.81
34081-2003	34081-3003	GOLD	14	2.0	3.6	5.00	1.7	2.90	12.82	0.600	1.194	6.86	0.90	1.778	6.73	2.438	0.12	3.429	1.575	6.11	0.10	1.13	6.34	5.79	4°	5.59
			16	1.5	3.6	5.00	1.7	2.90	12.82	0.600	1.194	6.86	0.90	1.778	6.73	2.438	0.12	3.429	1.575	6.11	0.10	1.13	6.34	5.79	4°	5.59
34081-2004	34081-3004	GOLD	18	1.0	3.3	5.00	1.3	2.90	12.57	0.556	0.963	7.34	0.70	1.753	6.73	2.085	0.33	3.378	1.699	1.94	0.14	0.88	-	-	-	3.81
			20	0.75	3.3	5.00	1.3	2.90	12.57	0.556	0.963	7.34	0.70	1.753	6.73	2.085	0.33	3.378	1.699	1.94	0.14	0.88	-	-	-	3.81
34081-2005	34081-3005	GOLD	22	0.5	2.5	4.85	0.9	2.90	11.92	0.414	0.714	6.27	0.55	1.737	7.06	1.576	0.26	3.327	1.524	2.00	0.07	1.08	-	-	-	3.81
			14	2.0	3.6	5.00	1.7	2.90	12.82	0.600	1.194	6.86	0.90	1.778	6.73	2.438	0.12	3.429	1.575	6.11	0.10	1.13	6.34	5.79	4°	5.59
34081-4001	34081-5001	SILVER	16	1.5	3.6	5.00	1.7	2.90	12.82	0.600	1.194	6.86	0.90	1.778	6.73	2.438	0.12	3.429	1.575	6.11	0.10	1.13	6.34	5.79	4°	5.59
			18	1.0	3.3	5.00	1.3	2.90	12.57	0.556	0.963	7.34	0.70	1.753	6.73	2.085	0.33	3.378	1.699	1.94	0.14	0.88	-	-	-	3.81
34081-4002	34081-5002	SILVER	20	0.75	3.3	5.00	1.3	2.90	12.57	0.556	0.963	7.34	0.70	1.753	6.73	2.085	0.33	3.378	1.699	1.94	0.14	0.88	-	-	-	3.81
			22	0.5	2.5	4.85	0.9	2.90	11.92	0.414	0.714	6.27	0.55	1.737	7.06	1.576	0.26	3.327	1.524	2.00	0.07	1.08	-	-	-	3.81

<b>ENTER DESCRIPTION</b> EC NO. 141/2010-04-9 DR. DWAN FERGUSON 2009/12/02 CHK'D BY A. DHIR 2009/04/15 APPR'D BY B. MOSELER 2009/04/15 A5	QUALITY SYMBOLS 0 1	GENERAL TOLERANCES (UNLESS SPECIFIED) mm INCH 4 PLACES ± --- ± --- 3 PLACES ± --- ± --- 2 PLACES ± 0.10 ± --- 1 PLACE ± 0.3 ± --- ANGULAR ± 3°	DIMENSION STYLE MM ONLY SCALE 1:1 DESIGN UNITS METRIC THIRD ANGLE PROJECTION	DRAWN BY DATE K. FERGUSON 4/14/2009 CHECKED BY DATE A. DHIR 4/14/2009 APPROVED BY DATE B. MOSELER 4/14/2009	TITLE MX 150 RECEPTACLE CABLE SEAL
	MATERIAL NO. SEE TABLE		DOCUMENT NO. SD-34083-002		
	DRAFT WHERE APPLICABLE MUST REMAIN WITHIN DIMENSIONS		SHEET NO. 3 OF 3		
	THIS DRAWING CONTAINS INFORMATION THAT IS PROPRIETARY TO MOLEX INCORPORATED AND SHOULD NOT BE USED WITHOUT WRITTEN PERMISSION				
	MOLEX INCORPORATED				