

MINIATURE RELAY

1 POLE, 0.5A (HIGH FREQUENCY SIGNAL SWITCHING)

UM1 SERIES

RoHS Compliant

■ FEATURES

- Subminiature polarized relay
- Excellent high frequency characteristics
 - Isolation : min. 60 dB
 - Insertion loss : max. 1 dB
 - V.S.W.R. : max. 1.2
 } at 900 MHz (Impedance of the measuring devices is 75Ω)
- High reliability— Bifurcated contacts
 - Movable contact: gold overlay
 - Stationary contact: gold clad
- Wide operating range
- DIL pitch terminals
- Plastic sealed type
- Latching type available
- RoHS compliant since date code: 0437T2
Please see page 7 for more information

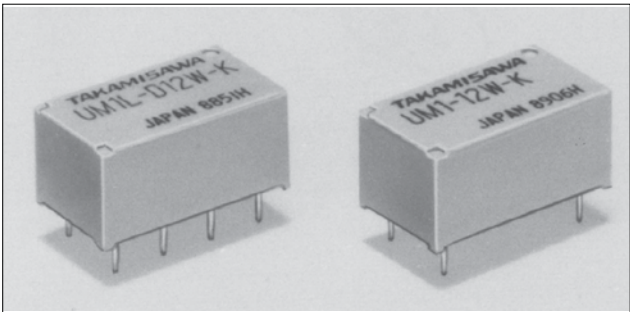

■ ORDERING INFORMATION

[Example] $\frac{UM1}{(a)} \frac{L}{(b)} - \frac{D}{(c)} \frac{12}{(d)} \frac{W}{(e)} - \frac{K}{(f)}$

(a)	Series Name	UM1: UM1 Series
(b)	Operation Function	Nil : Standard type L : Latching type
(c)	Number of Coil	Nil : Single winding type D : Double winding type
(d)	Nominal Voltage	Refer to the COIL DATA CHART
(e)	Contact	W : Bifurcated type (cross bar)
(f)	Enclosure	K : Plastic sealed type

UM1 SERIES

■ SPECIFICATIONS

Item		Standard Type	Single Winding Latching Type	Double Winding Latching Type
		UM1-() W-K	UM1L-() W-K	UM1L-D () W-K
Contact	Arrangement	1 form C (SPDT)		
	Material	Gold clad (stationary contact), gold plate (movable contact)		
	Style	Bifurcated (cross bar)		
	Resistance (initial)	Maximum 100 mΩ		
	Rating (resistive)	10 mA 24 VDC 1 W (at 900 MHz)		
	Maximum Carrying Current	0.5 A		
	Maximum Switching Power	1 W (DC) 10 W (at 900 MHz)		
	Maximum Switching Voltage	30 VDC		
	Maximum Switching Current	100 mA		
	Minimum Switching Load*1	0.01 mA 10 mVDC		
Excellent High Frequency Characteristics	Isolation	Minimum 60 dB (at 900 MHz), impedance of the measuring devices is 75Ω		
	Insertion Loss	Maximum 1 dB (at 900 MHz), impedance of the measuring devices is 75Ω		
	V.S.W.R.	Maximum 1.2 (at 900 MHz), impedance of the measuring devices is 75Ω		
Coil	Nominal Power (at 20°C)	200 to 220 mW	200 mW	400 mW
	Operate Power (at 20°C)	100 to 110 mW	100 mW	200 mW
	Operating Temperature	-30°C to +80°C (no frost)		-30°C to +60°C (no frost)
Time Value	Operate (at nominal voltage)	Maximum 6 ms	Maximum 6 ms (set)	
	Release (at nominal voltage)	Maximum 5 ms	Maximum 6 ms (reset)	
Life	Mechanical	1 × 10 ⁶ operations minimum		
	Electrical	3 × 10 ⁵ operations minimum (at nominal load)		
Other	Vibration	Misoperation	10 to 55 Hz (double amplitude of 3.3 mm)	
		Endurance	10 to 55 Hz (double amplitude of 5.0 mm)	
	Shock	Misoperation	500 m/s ² (11 ±1 ms)	
		Endurance	1,000 m/s ² (6 ±1 ms)	
	Weight	Approximately 4 g		

*1 Minimum switching loads mentioned above are reference values. Please perform the confirmation test with the actual load before production since reference values may vary according to switching frequencies, environmental conditions and expected reliability levels.

■ INSULATION

Item	Standard	Single latch	Double latch
Isolation (initial)	Minimum 1,000 MΩ (at 500VDC)		
Dielectric Strength	500VAC 1 min., (open contact / contact and shield terminals)		
	1,000VAC 1 min., (coil contact/ coil and shield terminals)		

UM1 SERIES

■ COIL DATA CHART

	MODEL	Nominal voltage	Coil resistance ($\pm 10\%$)	Must operate voltage*1	Must release voltage*1	Nominal power
Standard Type	UM1- 1.5 W-K	1.5 VDC	11.2 Ω	+1.05 VDC	+0.08 VDC	200 mW
	UM1- 3 W-K	3 VDC	45 Ω	+2.1 VDC	+0.15 VDC	200 mW
	UM1- 4.5 W-K	4.5 VDC	101 Ω	+3.15 VDC	+0.23 VDC	200 mW
	UM1- 5 W-K	5 VDC	125 Ω	+3.5 VDC	+0.25 VDC	200 mW
	UM1- 6 W-K	6 VDC	180 Ω	+4.2 VDC	+0.3 VDC	200 mW
	UM1- 9 W-K	9 VDC	405 Ω	+6.3 VDC	+0.45 VDC	200 mW
	UM1- 12 W-K	12 VDC	720 Ω	+8.4 VDC	+0.6 VDC	200 mW
	UM1- 18 W-K	18 VDC	1,620 Ω	+12.6 VDC	+0.9 VDC	200 mW
	UM1- 24 W-K	24 VDC	2,880 Ω	+16.8 VDC	+1.2 VDC	200 mW
	UM1- 48 W-K	48 VDC	10,472 Ω	+33.6 VDC	+2.4 VDC	220 mW

Note: *1 Specified values are subject to pulse wave voltage.
All values in the table are measured at 20°C.

TO BE DISCONTINUED
IN MARCH 2009

UM1 SERIES

	MODEL	Nominal voltage	Coil resistance ($\pm 10\%$)	Set voltage*1	Reset voltage*1	Nominal power
Single Winding Latching Type	UM1L- 1.5 W-K	1.5 VDC	11.2 Ω	+1.05 VDC	-1.05 VDC	200 mW
	UM1L- 3 W-K	3 VDC	45 Ω	+2.1 VDC	-2.1 VDC	200 mW
	UM1L- 4.5 W-K	4.5 VDC	101 Ω	+3.15 VDC	-3.15 VDC	200 mW
	UM1L- 5 W-K	5 VDC	125 Ω	+3.5 VDC	-3.5 VDC	200 mW
	UM1L- 6 W-K	6 VDC	180 Ω	+4.2 VDC	-4.2 VDC	200 mW
	UM1L- 9 W-K	9 VDC	405 Ω	+6.3 VDC	-6.3 VDC	200 mW
	UM1L- 12 W-K	12 VDC	720 Ω	+8.4 VDC	-8.4 VDC	200 mW
	UM1L- 18 W-K	18 VDC	1,620 Ω	+12.6 VDC	-12.6 VDC	200 mW
	UM1L- 24 W-K	24 VDC	2,880 Ω	+16.8 VDC	-16.8 VDC	200 mW
	UM1L- 48 W-K	48 VDC	11,520 Ω	+33.6 VDC	-33.6 VDC	200 mW
Double Winding Latching Type	UM1L-D1.5 W-K	1.5 VDC	P 5.6 Ω	+1.05 VDC		400 mW
			S 5.6 Ω			
	UM1L-D 3 W-K	3 VDC	P 22.5 Ω	+2.1 VDC		400 mW
			S 22.5 Ω			
	UM1L-D4.5 W-K	4.5 VDC	P 50.6 Ω	+3.15 VDC		400 mW
			S 50.6 Ω			
	UM1L-D 5 W-K	5 VDC	P 62.5 Ω	+3.5 VDC		400 mW
			S 62.5 Ω			
	UM1L-D 6 W-K	6 VDC	P 90 Ω	+4.2 VDC		400 mW
			S 90 Ω			
	UM1L-D 9 W-K	9 VDC	P 202.5 Ω	+6.3 VDC		400 mW
			S 202.5 Ω			
	UM1L-D 12 W-K	12 VDC	P 360 Ω	+8.4 VDC		400 mW
			S 360 Ω			
	UM1L-D 18 W-K	18 VDC	P 810 Ω	+12.6 VDC		400 mW
			S 810 Ω			
	UM1L-D 24 W-K	24 VDC	P 1,440 Ω	+16.8 VDC		400 mW
			S 1,440 Ω			
UM1L-D 48 W-K	48 VDC	P 5,760 Ω	+33.6 VDC		400 mW	
		S 5,760 Ω				+33.6 VDC

Note: *1 Specified values are subject to pulse wave voltage.
All values in the table are measured at 20°C.

P: Primary coil S: Secondary coil

CHARACTERISTIC DATA

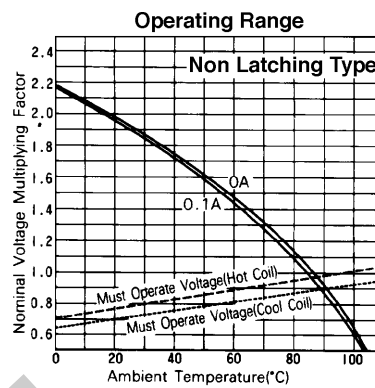
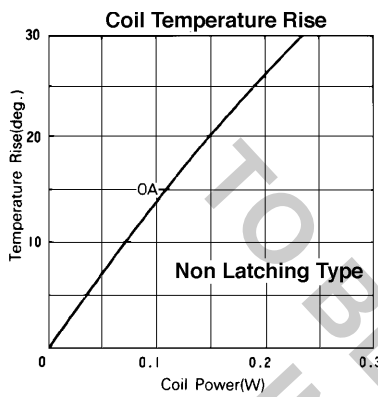
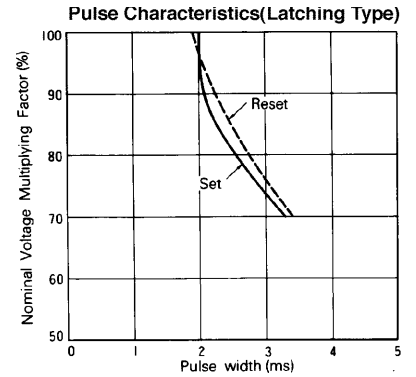
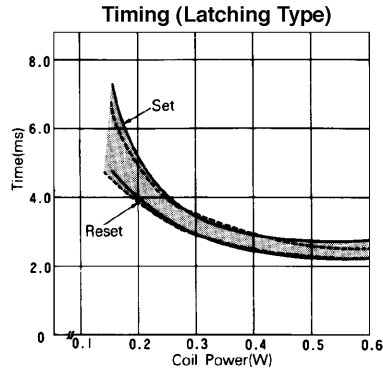
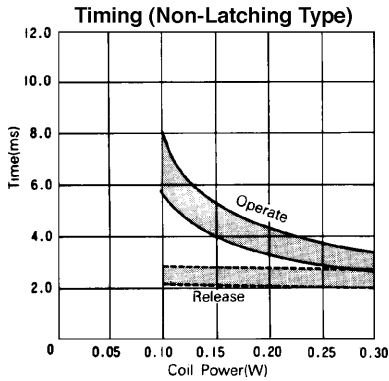

REFERENCE DATA

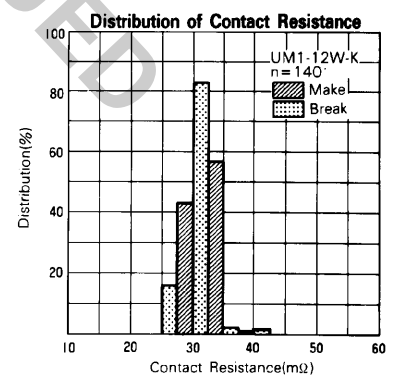
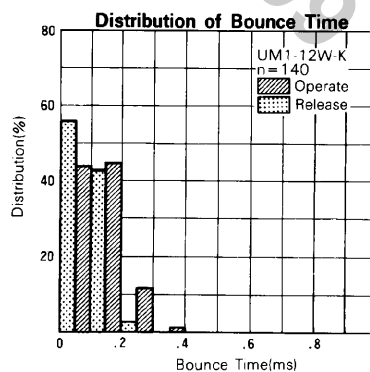
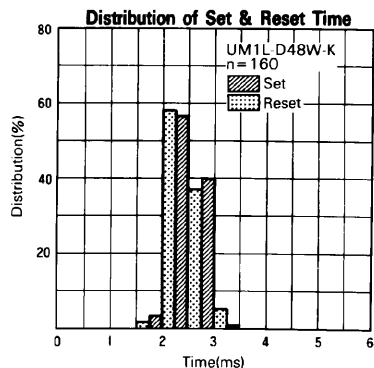
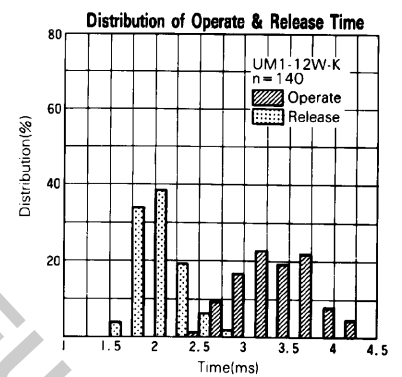
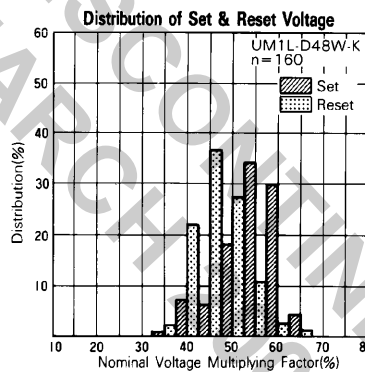
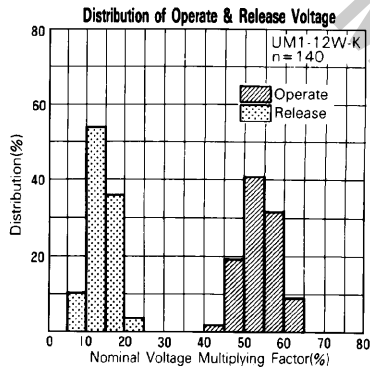

UM1 SERIES

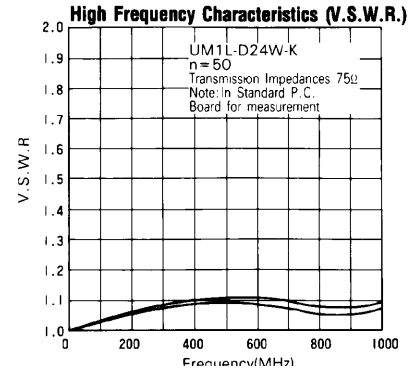
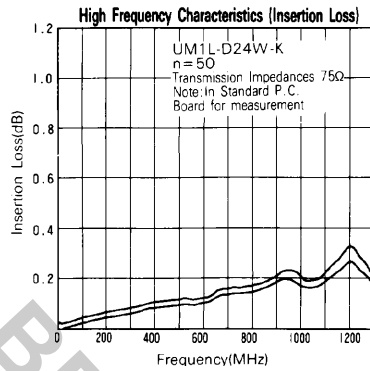
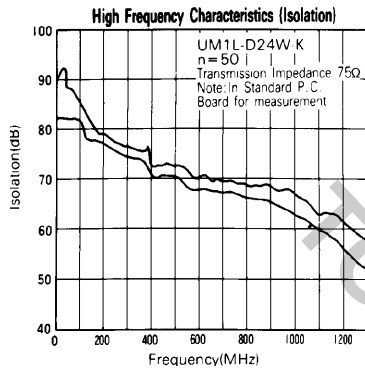
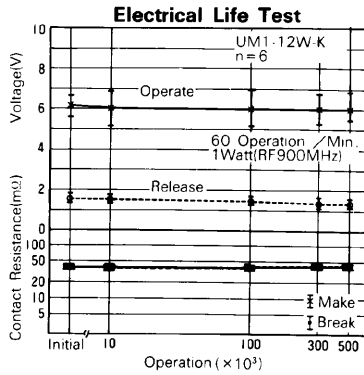
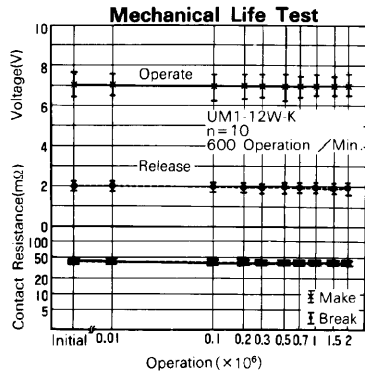

■ DIMENSIONS

● Dimensions

● Schematics

● PC board mounting hole layout

(Bottom view)

(Bottom view)

UM1, UM1L type (Non-latching type, single winding latching type)

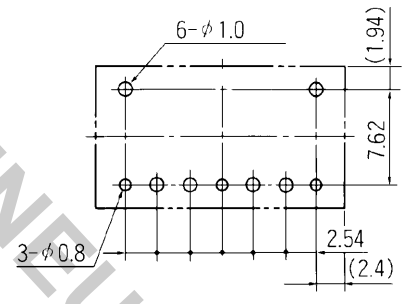
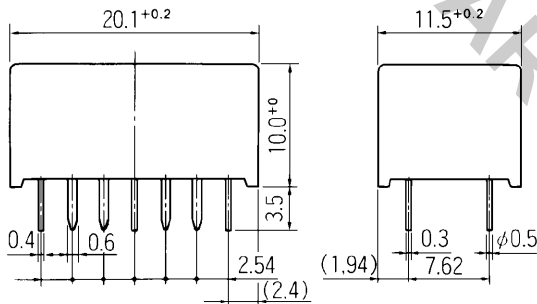

UM1L-D type (Double winding latching type)

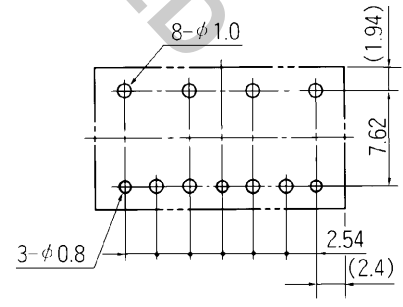
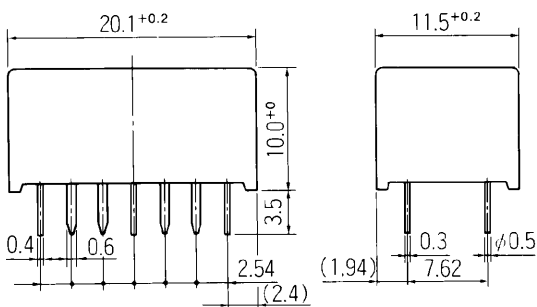

Unit: mm

RoHS Compliance and Lead Free Relay Information

1. General Information

- Relays produced after the specific date code that is indicated on each data sheet are lead-free now. All our signal and power relays are lead-free. Please refer to Lead-Free Status Info. (<http://www.fujitsu.com/us/downloads/MICRO/fcai/relays/lead-free-letter.pdf>)
- Lead free solder plating currently used in relays is Sn-3.0Ag-0.5Cu. From February 2005 forward Sn-3.0Cu-Ni will be used for FTRB3 and FTR-B4 series relays.
- All signal and power relays also comply with RoHS. Please refer to individual data sheets. Relays that are RoHS compliant do not contain the 6 hazardous materials above the threshold level that are restricted by RoHS directive (lead, mercury, cadmium, chromium IV, PBB, PBDE and DecaBDE).
- It has been verified that using lead-free relays in leaded assembly process will not cause any problems (compatible).
- "LF" is marked on each outer and inner carton. (No marking on individual relays).

2. Recommended Lead Free Solder Profile

- Recommended solder paste Sn-3.0Ag-0.5Cu.

Solder condition

Flow Solder condition:

Pre-heating: maximum 120°C
Soldering: dip within 5 sec. at
260°C solder bath

Solder by Soldering Iron:

Soldering Iron
Temperature: maximum 360°C
Duration: maximum 3 sec.

We highly recommend that you confirm your actual solder conditions

3. Moisture Sensitivity

- Moisture Sensitivity Level standard is not applicable to electromechanical relays.

4. Tin Whisker

- Dipped SnAgCu solder is known as low risk tin whisker. No considerable whisker length was found by our in house test.

Fujitsu Components International Headquarter Offices

Japan

Fujitsu Component Limited
Gotanda-Chuo Building
3-5, Higashigotanda 2-chome, Shinagawa-ku
Tokyo 141, Japan
Tel: (81-3) 5449-7010
Fax: (81-3) 5449-2626
Email: promothq@ft.ed.fujitsu.com
Web: www.fcl.fujitsu.com/en/

North and South America

Fujitsu Components America, Inc.
250 E. Caribbean Drive
Sunnyvale, CA 94089 U.S.A.
Tel: (1-408) 745-4900
Fax: (1-408) 745-4970
Email: components@us.fujitsu.com
Web: <http://www.fujitsu.com/us/services/edevices/components/>

Europe

Fujitsu Components Europe B.V.
Diamantlaan 25
2132 WV Hoofddorp
Netherlands
Tel: (31-23) 5560910
Fax: (31-23) 5560950
Email: info@fceu.fujitsu.com
Web: emea.fujitsu.com/components/

Asia Pacific

Fujitsu Components Asia Ltd.
102E Pasir Panjang Road
#01-01 Citilink Warehouse Complex
Singapore 118529
Tel: (65) 6375-8560
Fax: (65) 6273-3021
Email: fcal@fcal.fujitsu.com
Web: <http://www.fujitsu.com/sg/services/micro/components/>

©2008 Fujitsu Components America, Inc. All rights reserved. All trademarks or registered trademarks are the property of their respective owners.

Fujitsu Components America or its affiliates do not warrant that the content of datasheet is error free. In a continuing effort to improve our products Fujitsu Components America, Inc. or its affiliates reserve the right to change specifications/datasheets without prior notice.
Rev. December 23, 2008.

TO BE DISCONTINUED
IN MARCH 2009