

## CPDT5-5V0 (RoHS Device)

### Features

- Common anode ESD protection.
- IEC61000-4-2 8kV(Contact), 15kV(air).
- Low operating voltage: < 5V.
- Fast turn-on and low clamping voltage.

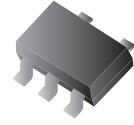

### Mechanical data

- Case: SOT-23-5 Standard package, molded plastic.
- Terminals: Gold plated, solderable per MIL-STD-750D, method 2026.
- Marking code:E05
- Mounting position: Any.
- Weight: 0.0153 gram(approx.).

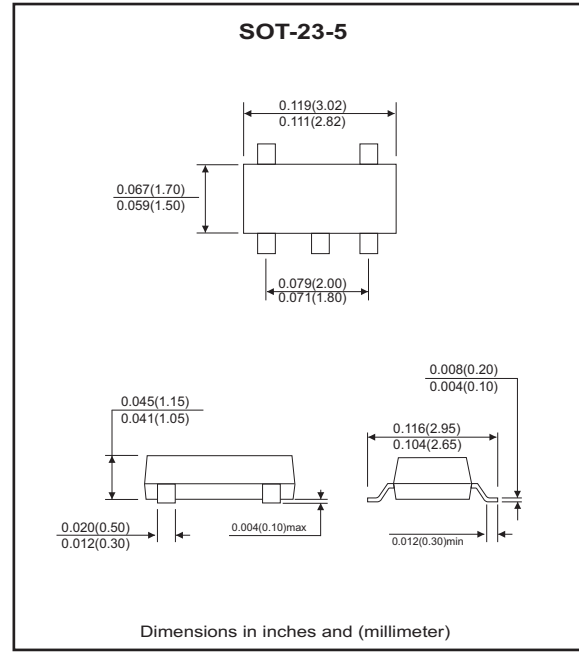
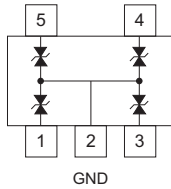

### Electrical Characteristics (at TA=25°C unless otherwise noted)

Parameter	Conditions	Symbol	Min	Typ	Max	Unit
Diode breakdown voltage	I <sub>R</sub> = 1mA	V <sub>BD</sub>	5.1	7.0		V
Leakage current	V <sub>R</sub> = 5V	I <sub>L</sub>		0.1	2.0	uA
Junction capacitance	V <sub>R</sub> = 0V, f = 1MHz	C <sub>T</sub>		15	20	pF
ESD capability	IEC 61000-4-2(air) IEC 61000-4-2(contact)	ESD			16 8	kV
Clamping voltage	I <sub>PP</sub> = 5A, T <sub>P</sub> =8/20us	V <sub>C</sub>			15	V
Peak pulse power	T <sub>P</sub> =8/20us	P <sub>PP</sub>			75	W
Operation temperature		T <sub>j</sub>			125	°C
Storage temperature		T <sub>STG</sub>	-55		150	°C

## RATING AND CHARACTERISTIC CURVES (CPDT5-5V0)

Fig. 1 - 8/20us Peak pulse current wave form acc. IEC 61000-4-5

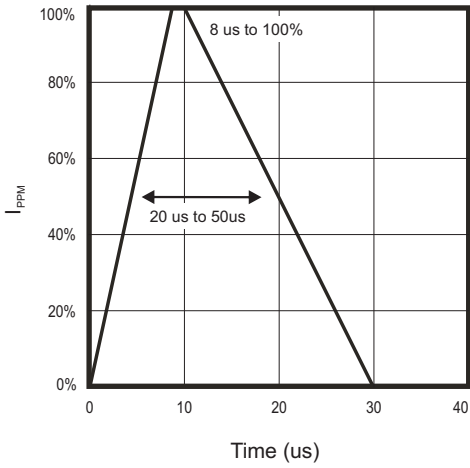

Fig. 2 - Reverse characteristics

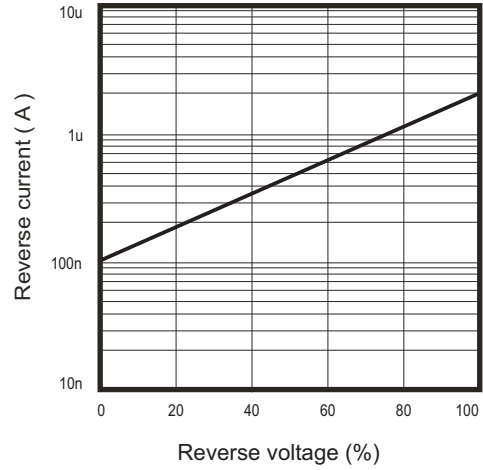

Fig. 3 - Capacitance between terminals characteristics

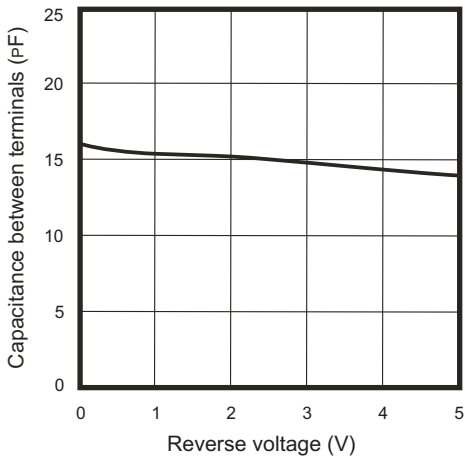
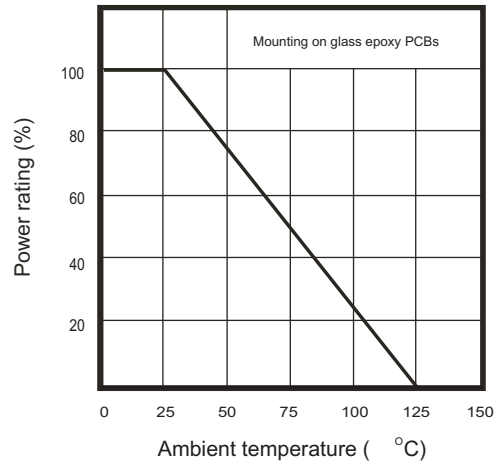
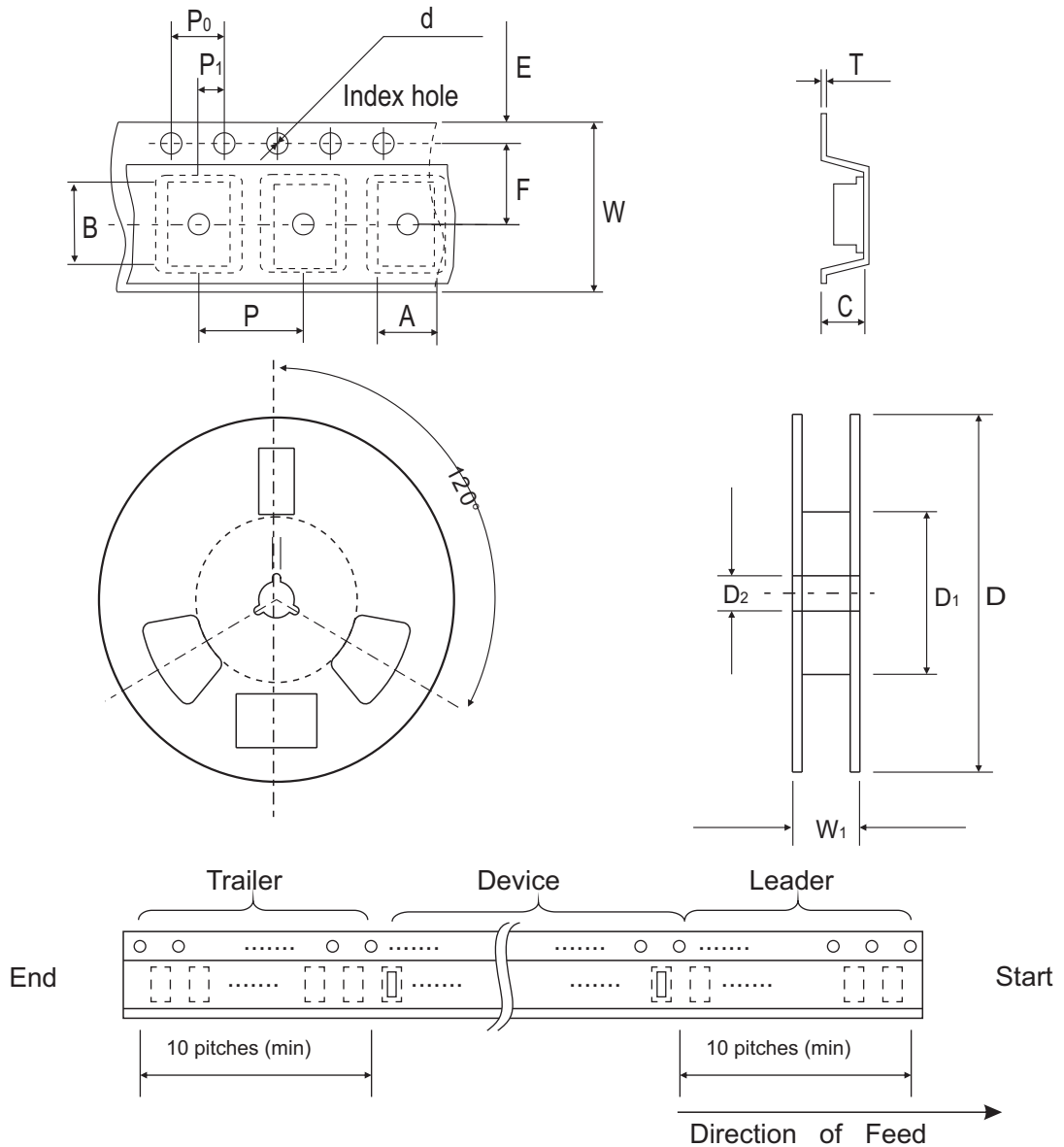

Fig. 4 - Power rating derating curve



## Reel Taping Specification



SOT-23-5	SYMBOL	A	B	C	d	D	D <sub>1</sub>	D <sub>2</sub>
	(mm)	3.17 ± 0.10	3.23 ± 0.10	1.37 ± 0.10	1.55 ± 0.10	178 ± 1	50.0 MIN.	13.0 ± 0.20
	(inch)	0.125 ± 0.004	0.127 ± 0.004	0.054 ± 0.004	0.061 ± 0.004	7.008 ± 0.040	1.969 MIN.	0.512 ± 0.008

SOT-23-5	SYMBOL	E	F	P	P <sub>0</sub>	P <sub>1</sub>	W	W <sub>1</sub>
	(mm)	1.75 ± 0.10	3.50 ± 0.05	4.00 ± 0.10	4.00 ± 0.10	2.00 ± 0.05	8.00 ± 0.30	14.4 MAX.
	(inch)	0.069 ± 0.004	0.138 ± 0.002	0.157 ± 0.004	0.157 ± 0.004	0.079 ± 0.002	0.315 ± 0.012	0.567 MAX

## Marking Code

Part Number	Marking Code
CPDT5-5V0	E05

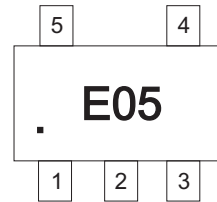

## Suggested PAD Layout

SIZE	SOT-23-5	
	(mm)	(inch)
A	1.10	0.043
B	0.60	0.024
C	0.95	0.037
D	2.50	0.098
E	3.60	0.142

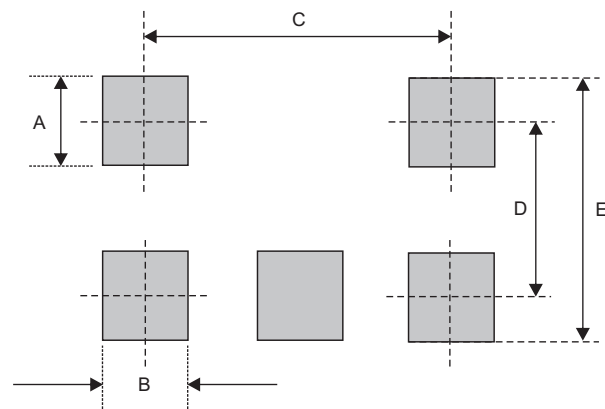

## Standard Package

Case Type	Qty per Reel	Reel Size
	(Pcs)	(inch)
SOT-23-5	3000	7