

**PLEASE CHECK WWW.MOLEX.COM FOR LATEST PART INFORMATION**

**Part Number:** [5017843008](#)  
**Status:** **Active**  
**Description:** 0.50mm (.020") Pitch FFC-to-Board Connector, Plug Jacket Cover, with Ground type, 30 Circuits

**Documents:**

[Drawing \(PDF\)](#) [RoHS Certificate of Compliance \(PDF\)](#)  
[Product Specification PS-501864-004 \(PDF\)](#)

**General**

|                |              |
|----------------|--------------|
| Product Family | Accessories  |
| Series         | 501784       |
| Component Type | Jacket Cover |
| Product Name   | N/A          |

**Physical**

|                               |                |
|-------------------------------|----------------|
| Breakaway                     | No             |
| Circuits (Loaded)             | N/A            |
| Circuits (maximum)            | 30             |
| Color - Resin                 | Black          |
| Gender                        | Plug           |
| Material - Resin              | Polyester      |
| Packaging Type                | Bag            |
| Polarized to Mating Part      | Yes            |
| Temperature Range - Operating | -40°C to +85°C |

**Electrical**

|                               |      |
|-------------------------------|------|
| Current - Maximum per Contact | 0.5A |
|-------------------------------|------|

**Material Info**

**Reference - Drawing Numbers**

|                       |   |
|-----------------------|---|
| Product Specification | PS-501864-004, RPS-501786-001, RPS-501864-001 |
| Sales Drawing         | SD-501784-005                                 |

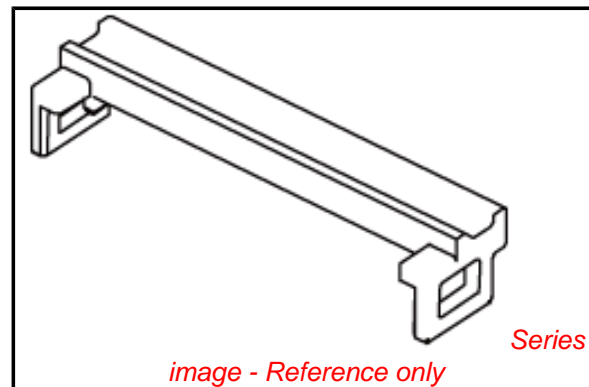

*image - Reference only*

**EU RoHS**

**ELV and RoHS  
Compliant**  
**REACH SVHC  
Contains SVHC: No  
Halogen-Free  
Status**

**China RoHS**



**Need more information on product  
environmental compliance?**

Email [productcompliance@molex.com](mailto:productcompliance@molex.com)  
 For a multiple part number RoHS Certificate of Compliance, [click here](#)

Please visit the [Contact Us](#) section for any non-product compliance questions.

**Search Parts in this Series**

501784Series

**Use With**

501786 FFC-to-Board Connector, 501864 FFC-to-Board Connector, 501783 Plug Jacket

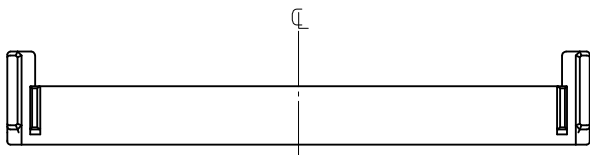
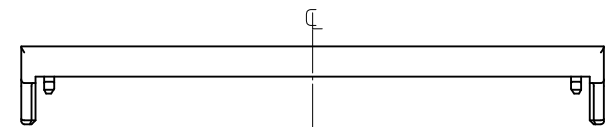
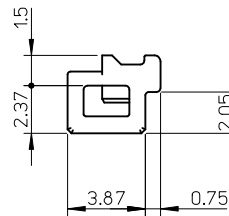
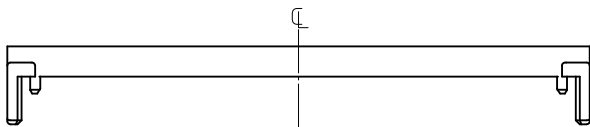
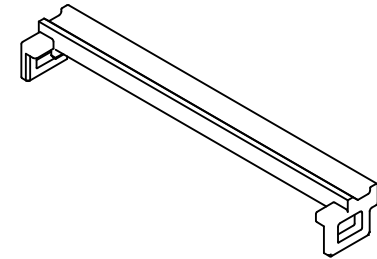
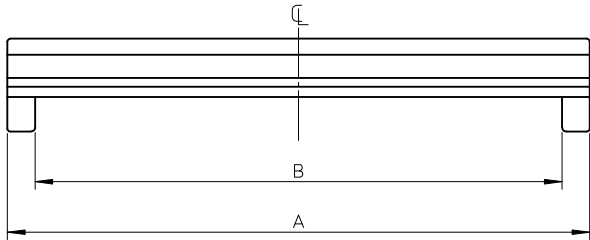

|                                  |       |                     |          |
|----------------------------------|-------|---------------------|----------|
| 41.2                             | 43.96 | 501784-8009         | 80       |
| 26.2                             | 28.96 | 501784-5009         | 50       |
| B                                | A     | PLASTIC BAG PACKAGE | 極数       |
|                                  |       | オーダー番号 ORDER NO.    | CIRCUITS |
| CONNECTOR SERIES NO. 501784-**09 |       |                     |          |

注記  
NOTES

- 適合プラグジャケット: 501783-\*\*09  
APPLICABLE PLUG JACKET : 501783-\*\*09
- 材質  
MATERIAL  
PBT, UL94V-0, 色: 黒色  
PBT, UL94V-0, COLOR: BLACK

|  |             |   |       |  |                  |   |                               |                        |  |
|--|-------------|---|-------|--|------------------|---|-------------------------------|------------------------|--|
| REVISED<br>EC NO.: J2010-1937<br>DRWN: YMORI 2010/03/26<br>CHKD: MATSUURA 2010/03/26<br>APPR: KMORIKAWA 2010/05/10 | DESCRIPTION | GENERAL TOLERANCES (UNLESS SPECIFIED)   |       | DIMENSION STYLE<br>MM ONLY                           |                  | SCALE<br>--//                                       | DESIGN UNITS<br>METRIC        | THIRD ANGLE PROJECTION |  |
|  |             | 10 UNDER  | ±0.2  | DRAWN BY<br>H. IJIMA                                 | DATE<br>06/01/16 | TITLE<br>0.5 FFC TO BOARD CONN<br>PLUG JACKET COVER |                               |                        |  |
|  |             | 10 OVER 30 UNDER  | ±0.25 | CHECKED BY<br>K. TAKAHASHI                           | DATE<br>06/01/16 | MOLEX INCORPORATED                                  |                               |                        |  |
|  |             | 30 OVER   | ±0.3  | APPROVED BY<br>H. HIRATA                             | DATE<br>06/01/16 |   |                               |                        |  |
|  |             | ANGULAR ±1 °  |       | DRAFT WHERE APPLICABLE MUST REMAIN WITHIN DIMENSIONS |                  | MATERIAL NO.<br>501784-**09                         | DOCUMENT NO.<br>SD-501784-001 | SHEET NO.<br>1 OF 1    |  |
| A  | REV         | THIS DRAWING CONTAINS INFORMATION THAT IS PROPRIETARY TO MOLEX INCORPORATED AND SHOULD NOT BE USED WITHOUT WRITTEN PERMISSION |       |  |                  |   |                               |                        |  |

10 9 8 7 6 5 4 3 2 1

F

E

D

C

B

A

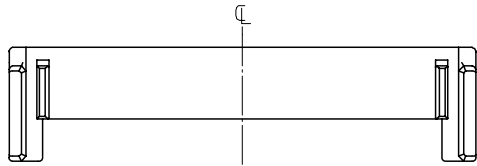
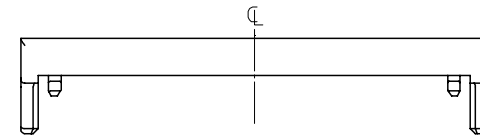
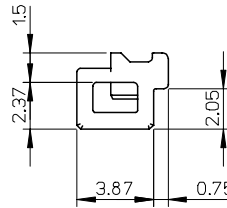
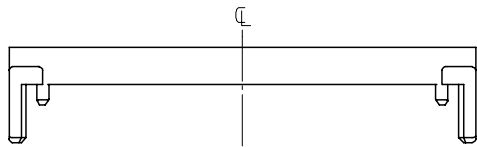
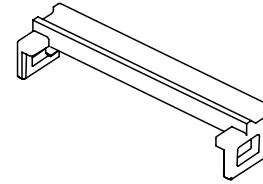
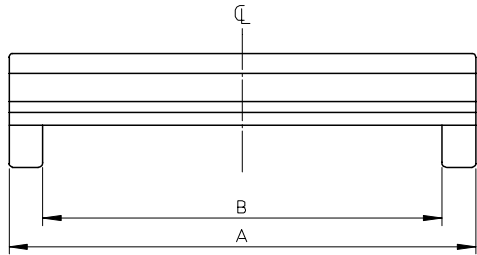

注記  
NOTES

- 1.適合プラグジャケット: 501783-\*\*09  
APPLICABLE PLUG JACKET : 501783-\*\*09
- 2.材質  
MATERIAL  
PBT・UL94V-0、色:黒色  
PBT, UL94V-0, COLOR:BLACK
- 3.ELV及びRoHS適合品  
ELV AND RoHS COMPLIANT

|      |       |              |       |
|------|-------|--------------|-------|
| 16.2 | 18.96 | 501784-3009  | 30    |
| B    | A     | MATERIAL NO. | CKTS. |

SCALE:  $\frac{1}{1}$  DESIGN UNITS: METRIC THIRD ANGLE PROJECTION

|  |                                       |  |                             |                  |   |
|--|---------------------------------------|--|-----------------------------|------------------|---|
| RELEASED<br>EC NO: J2008-2176<br>DRWNG SETO 2007/11/29<br>CHKD: MORIKAWA 2007/11/29<br>APPR: MORIKAWA 2007/11/30 | GENERAL TOLERANCES (UNLESS SPECIFIED) |  | DIMENSION STYLE<br>MM ONLY  |                  | TITLE<br>0.5 FFC TO BOARD CONN<br>PLUG JACKET COVER |
|  | 10 UNDER                              | ±0.2   | DRAWN BY<br>H. IJIMA        | DATE<br>07/11/27 |   |
|  | 10 OVER 30 UNDER                      | ±0.25  | CHECKED BY<br>K. MORIKAWA   | DATE<br>07/11/27 |   |
|  | 30 OVER                               | ±0.3   | APPROVED BY<br>H. HIRATA    | DATE<br>07/11/27 |   |
|  | ANGULAR ±1 °                          |  | MATERIAL NO.<br>501784-**09 |                  | DOCUMENT NO.<br>SD-501784-004                       |
| DRAFT WHERE APPLICABLE<br>MUST REMAIN<br>WITHIN DIMENSIONS   |                                       | MOLEX INCORPORATED<br>THIS DRAWING CONTAINS INFORMATION THAT IS PROPRIETARY TO MOLEX<br>INCORPORATED AND SHOULD NOT BE USED WITHOUT WRITTEN PERMISSION |                             |                  |   |