

PLEASE CHECK WWW.MOLEX.COM FOR LATEST PART INFORMATION

Part Number: [0190740014](#)
Status: **Active**
Description: Krimptite™ Steel Star Ring Tongue Terminal for 18-22 AWG Wire, Stud Size 10, Mylar Tape Carrier

Documents:

[Drawing \(PDF\)](#) [RoHS Certificate of Compliance \(PDF\)](#)

Agency Certification

CSA LR18689
 UL E32244

General

Product Family Ring and Spade Terminals
 Series [19074](#)
 Crimp Quality Equipment Yes
 Mil-Spec N/A
 Product Name Krimptite™
 Type Ring

Physical

Barrel Type Closed
 Insulation None
 Material - Plating Mating Tin
 Packaging Type Adhesive Tape on Reel
 Stud Size 10 (M5)
 Wire Size AWG 18, 20, 22
 Wire Size mm² 0.30 - 1.00

Material Info

Old Part Number SRA-S-129-10T

Reference - Drawing Numbers

Sales Drawing CD1115

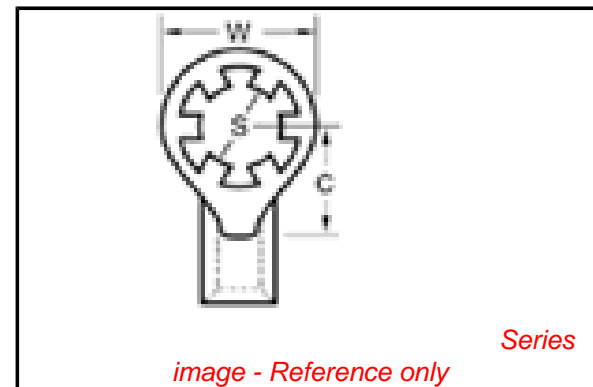

EU RoHS

ELV and RoHS Compliant
REACH SVHC
 Not Reviewed
Halogen-Free Status
Not Reviewed

China RoHS



Need more information on product environmental compliance?

Email productcompliance@molex.com
 For a multiple part number RoHS Certificate of Compliance, [click here](#)

Please visit the [Contact Us](#) section for any non-product compliance questions.

Search Parts in this Series

[19074Series](#)

Application Tooling | [FAQ](#)

Tooling specifications and manuals are found by selecting the products below. Crimp Height Specifications are then contained in the Application Tooling Specification document.

Global

Description	Product #
ATP Perishable Tool Kit used in ATP presses that process product on tape	0190270071

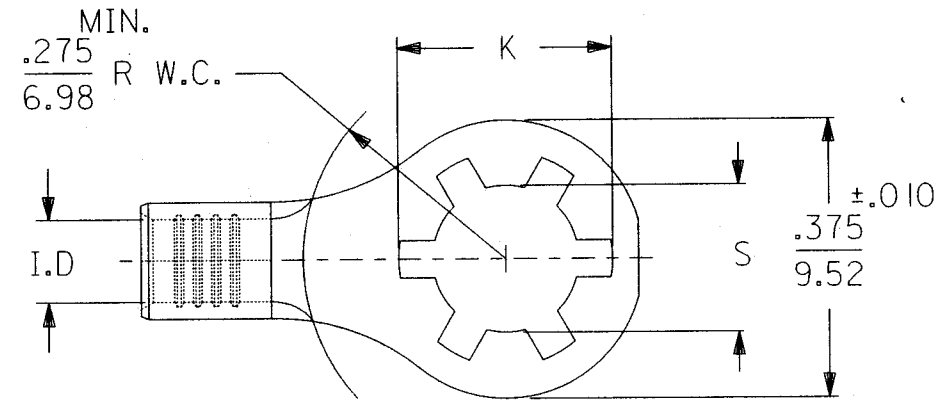

STUD SIZE	±.007 "S" DIA.	REF. "K" DIA.
#6	.146	.236
#8	.173	.263
#10	.198	.288

D

D

C

C

B

B

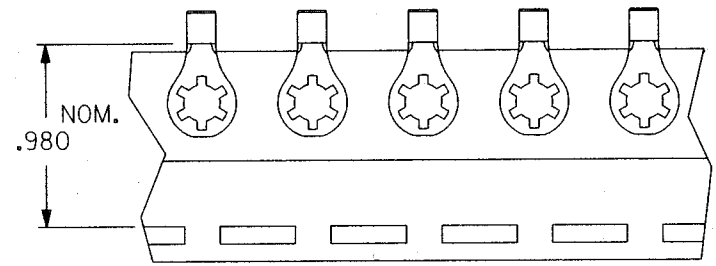
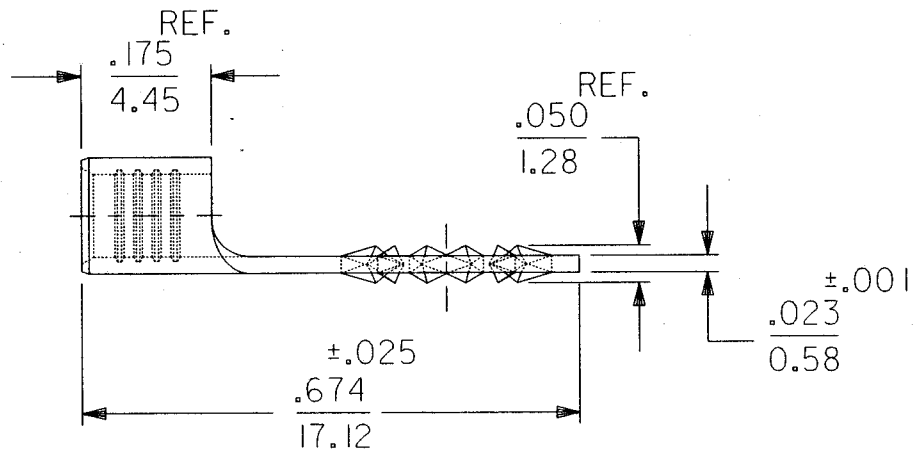

TO ORDER PARTS ON TAPE ADD A "T" TO THE END OF THE PART NUMBER

TERMINAL MATERIAL: SEE CHART
TERMINAL PLATING: ELECTRO-TIN

PART NO. BRASS	PART NO. STEEL	WIRE RANGE AWG / MM ²	I.D. MIN.
SRA-129-	SRA-S-129-	22-18/.25-1.3	.073/1.85 (B)
SRB-129-	SRB-S-129-	16-14/1.0-2.6	.100/2.54 (B)

B	ETC2005-1112 ID TYPO RWD 05/01/05
A	SEE DCN# 764 10/07/91 RCM
LTR.	REVISIONS

A

A

REVISE ONLY ON CAD SYSTEM

TITLE
KRIMPTITE
STAR RING TONGUE
TERMINALS

SALES
DRAWING

DRWG. BY	RCM
CHK'D. BY	JM
APP'D. BY	FP
SCALE	NO:NE

moLEX ETC INC.
PINELLAS PARK, FLA. 34665 U.S.A.

PART NO. SEE TABLE

DRWG. NO. CD-1115

SHEET NO. DATE 09/05/91

FILE NAME CD1115 THIS DRAWING CONTAINS INFORMATION THAT IS PROPRIETARY TO MOLEX-ETC INC. AND SHOULD NOT BE USED WITHOUT WRITTEN PERMISSION. DIV. SIZE A