

Features

- High Luminous LEDs
- 5.2x3.8mm Standard Directivity
- Superior Weather-resistance
- UV Resistant Epoxy
- Water Clear Type

Applications

- Electronic Signs And Signals
- Small Area Illuminations
- Back Lighting
- Other Lighting

Outline Dimension

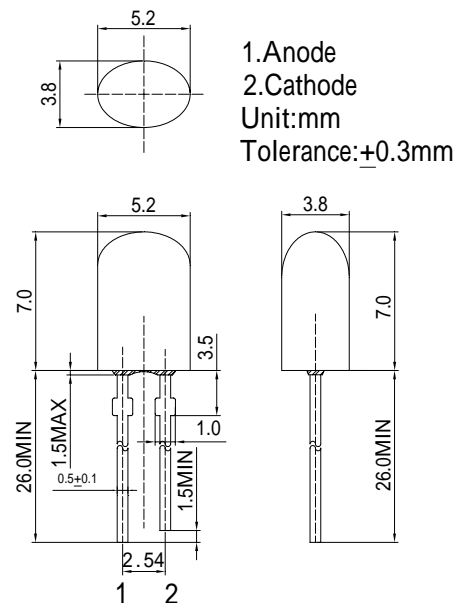

Absolute Maximum Rating

($T_a=25$)

Item	Symbol	Value	Unit
DC Forward Current	I_F	30	mA
Pulse Forward Current*	I_{FP}	100	mA
Reverse Voltage	V_R	5	V
Power Dissipation	P_D	72	mW
Operating Temperature	T_{opr}	-30 ~ +85	
Storage Temperature	T_{stg}	-40 ~ +100	
Lead Soldering Temperature	T_{sol}	260 /5sec	-

*Pulse width Max.10ms Duty ratio max 1/10

Directivity

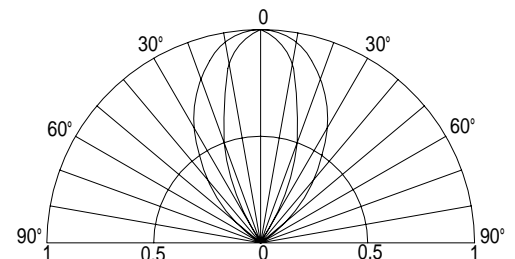

Electrical -Optical Characteristics

($T_a=25$)

Item	Symbol	Condition	Min.	Typ.	Max.	Unit
DC Forward Voltage	V_F	$I_F=20$ mA	1.8	2.1	2.4	V
DC Reverse Current	I_R	$V_R=5$ V	-	-	10	μ A
Domi. Wavelength*	λ_D	$I_F=20$ mA	600	605	610	nm
Luminous Intensity*	I_v	$I_F=20$ mA	-	1500	-	mcd
50% Power Angle	$2\theta_{1/2}$	$I_F=20$ mA	-	70/40	-	deg

*1 Tolerance of dominant wavelength is ± 1 nm

*2 Tolerance of luminous intensity is $\pm 15\%$