

## Features

- \* High Intensity.
- \* Popular T-1 3/4 diameter Package.
- \* Selected minimum intensities.
- \* General purpose leads.
- \* Reliable and rugged.

## Package Dimensions

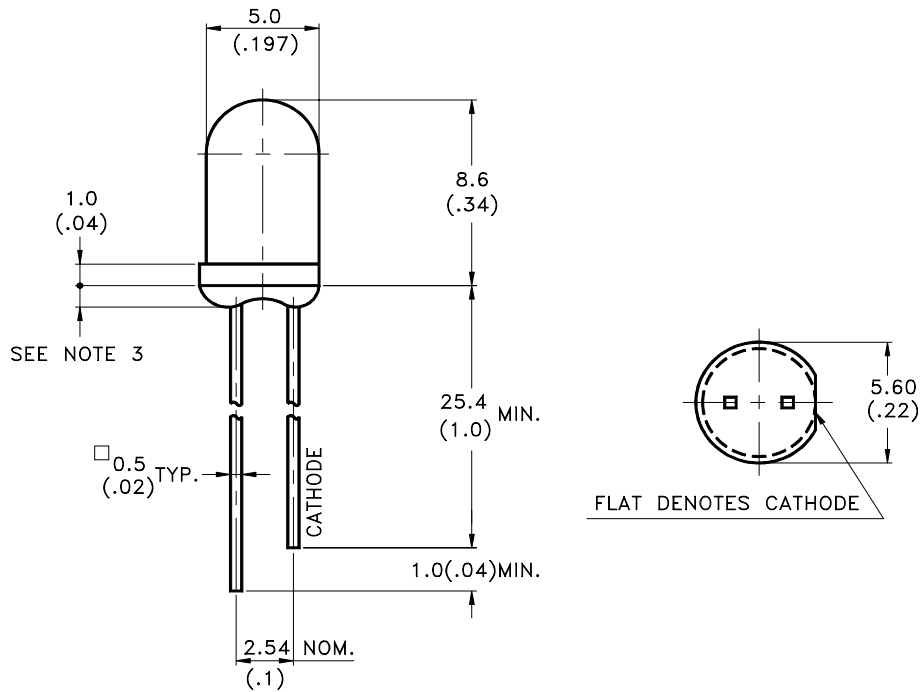

Part No.	Lens	Source Color
LTL-4224	Red Transparent	Hi-Eff.Red

### Notes:

1. All dimensions are in millimeters (inches).
2. Tolerance is  $\pm 0.25\text{mm}(.010\text{'})$  unless otherwise noted.
3. Protruded resin under flange is 1.0mm(.04") max.
4. Lead spacing is measured where the leads emerge from the package.
5. Specifications are subject to change without notice.



**Absolute Maximum Ratings at TA=25°C**

Parameter	Maximum Rating	Unit
Power Dissipation	100	mW
Peak Forward Current (1/10 Duty Cycle, 0.1ms Pulse Width)	120	mA
Continuous Forward Current	30	mA
Derating Linear From 50°C	0.4	mA/°C
Reverse Voltage	5	V
Operating Temperature Range	-55°C to + 100°C	
Storage Temperature Range	-55°C to + 100°C	
Lead Soldering Temperature [1.6mm(.063") From Body]	260°C for 5 Seconds	

## Electrical / Optical Characteristics at TA=25°C

Parameter	Symbol	Min.	Typ.	Max.	Unit	Test Condition
Luminous Intensity	I <sub>v</sub>	29	90		mcd	I <sub>F</sub> = 10mA Note 1,4
Viewing Angle	2θ <sub>1/2</sub>		16		deg	Note 2 (Fig.6)
Peak Emission Wavelength	λ <sub>P</sub>		635		nm	Measurement @Peak (Fig.1)
Dominant Wavelength	λ <sub>d</sub>		623		nm	Note 3
Spectral Line Half-Width	Δλ		40		nm	
Forward Voltage	V <sub>F</sub>		2.0	2.6	V	I <sub>F</sub> = 20mA
Reverse Current	I <sub>R</sub>			100	μA	V <sub>R</sub> = 5V
Capacitance	C		20		pF	V <sub>F</sub> = 0, f = 1MHz

Note: 1. Luminous intensity is measured with a light sensor and filter combination that approximates the CIE (Commission International De L'Eclairage) eye-response curve.

2. θ<sub>1/2</sub> is the off-axis angle at which the luminous intensity is half the axial luminous intensity.

3. The dominant wavelength, λ<sub>d</sub> is derived from the CIE chromaticity diagram and represents the single wavelength which defines the color of the device.

4. The I<sub>v</sub> guarantee should be added ± 15%.

## Typical Electrical / Optical Characteristics Curves

(25°C Ambient Temperature Unless Otherwise Noted)

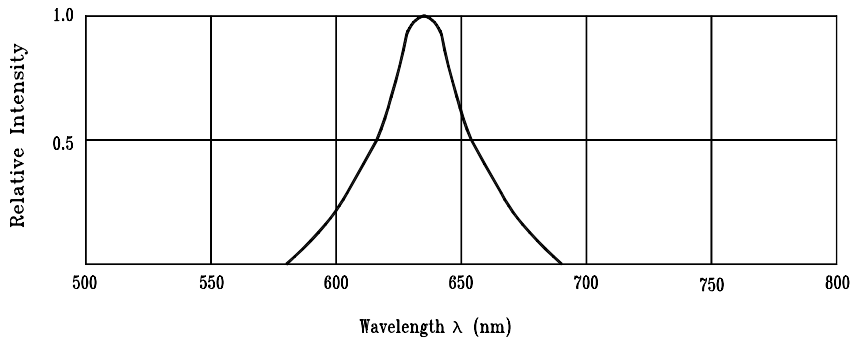

Fig.1 Relative Intensity vs. Wavelength

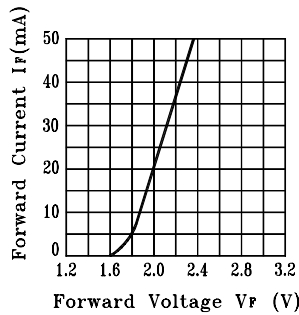

Fig.2 Forward Current vs. Forward Voltage

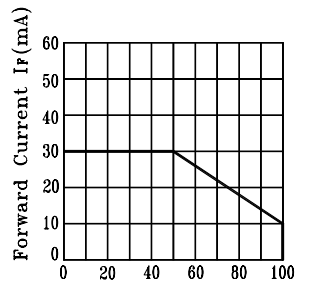

Fig.3 Forward Current Derating Curve

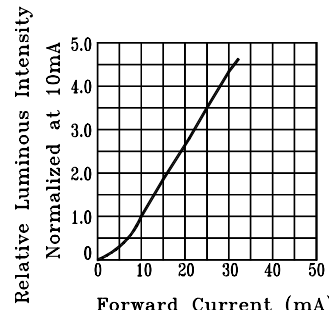

Fig.4 Relative Luminous Intensity vs. Forward Current

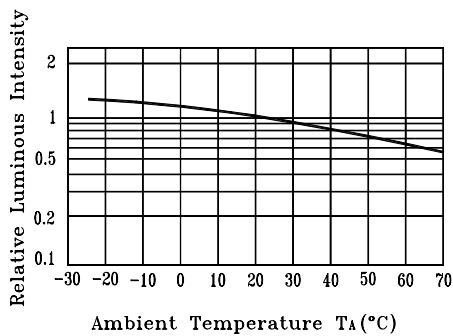

Fig.5 Luminous Intensity vs. Ambient Temperature

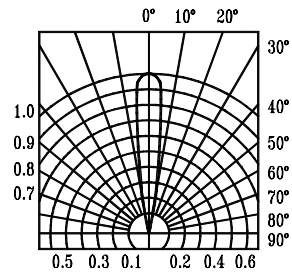

Fig.6 Spatial Distribution