

2-stage filter for 3-phase systems with neutral conductor

new

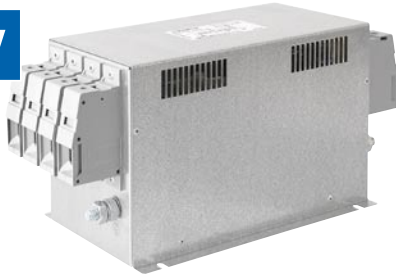

Description

- Terminals for three phases, neutral conductor and ground
- Very high symmetrical and asymmetrical attenuation loss
- In the frequency range from 10kHz up to 300MHz

Standards

- IEC 60939
- UL 1283, Edition 5, CSA 22.2 No. 8-M1986, @ Ta 75 °C

Approvals

- VDE License Number: pending
- UL License Number: E72928

Applications

- Voltage rating 520 VAC for world wide acceptance
- Protection against interference voltage from the mains
- Especially designed for industrial applications such as: Frequency Converters, Stepper Motor Drives, UPS-Systems, Inverters

References

[General Product Information](#)

Weblinks

[Approvals](#), [RoHS](#), [CHINA-RoHS](#), [Distributor-Stock-Check](#)

Technical Data

Rated Current	8 - 200 A
Rated voltage	300/520 VAC, 50/60 Hz
Approval for	8 - 200 A @ 50 (75) °C / 300/520 VAC; 50/60 Hz
Overload Current	1.5 x I _r
Dielectric Strength for 520 VAC	2.25 kVDC between L-L 1.7 kVDC between L-N 2.75 kVDC between L-PE 2.75 kVDC between N-PE Test voltage 2 sec
Number of Filter Stages	2
Weight	1.1 - 8.6 kg
Material: Housing	Metal
Sealing Compound	UL 94V-0

Mounting	Screw-on mounting on chassis
Terminal	Screw Clamp
Operating Temperature [°C]	-25 °C to 100 °C
Climatic Category	25/100/21 acc. to IEC 60068-1
Degree of Protection	IP 20 acc. to IEC 60529
Protection Class	Suitable for appliances with protection class 1 acc. to IEC 61140
MTBF	> 200'000h acc. to MIL-HB-217 F

Dimensions

Case 2A

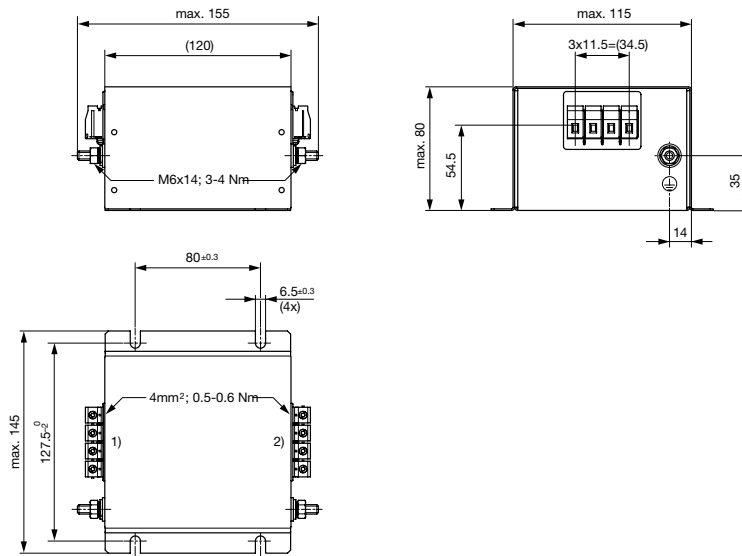

- 1) Line
- 2) Load

Case 2B

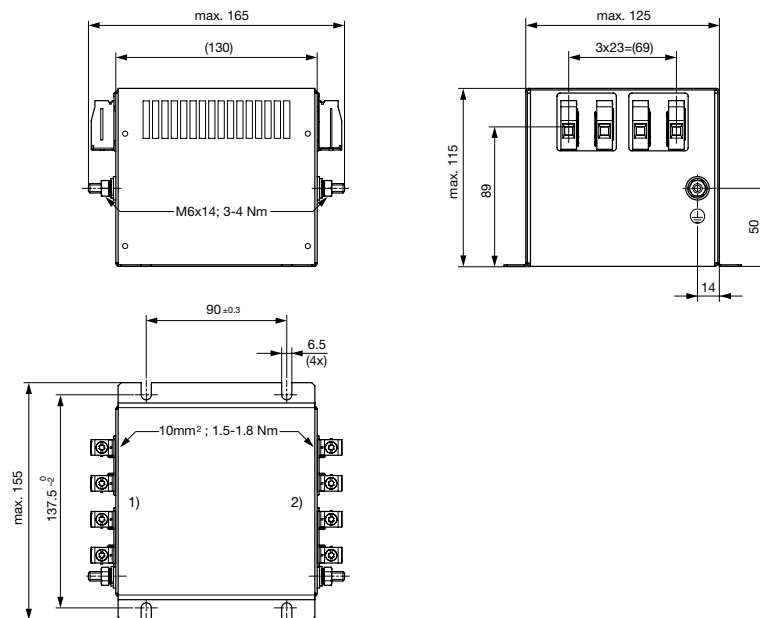

- 1) Line
- 2) Load

Case 2C

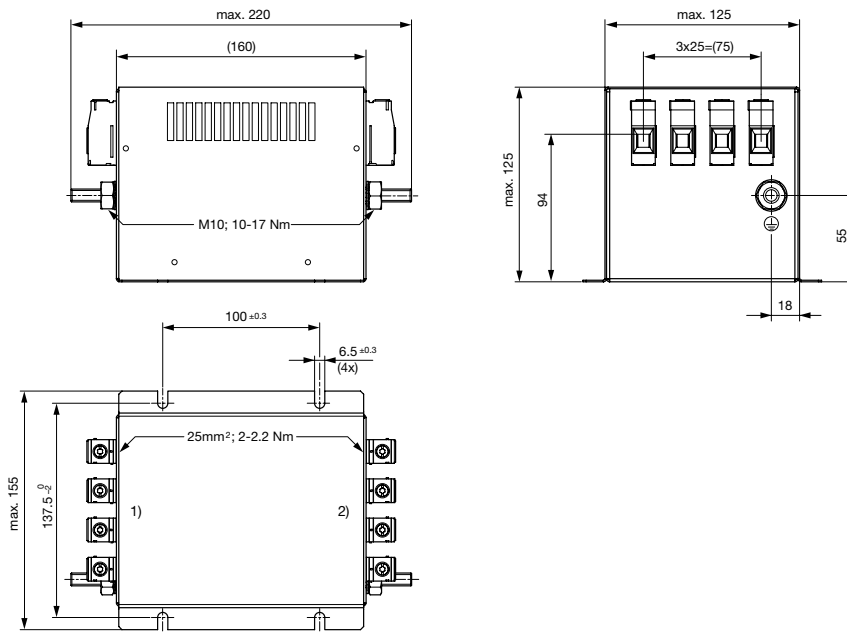

- 1) Line
 - 2) Load
- Case 2D

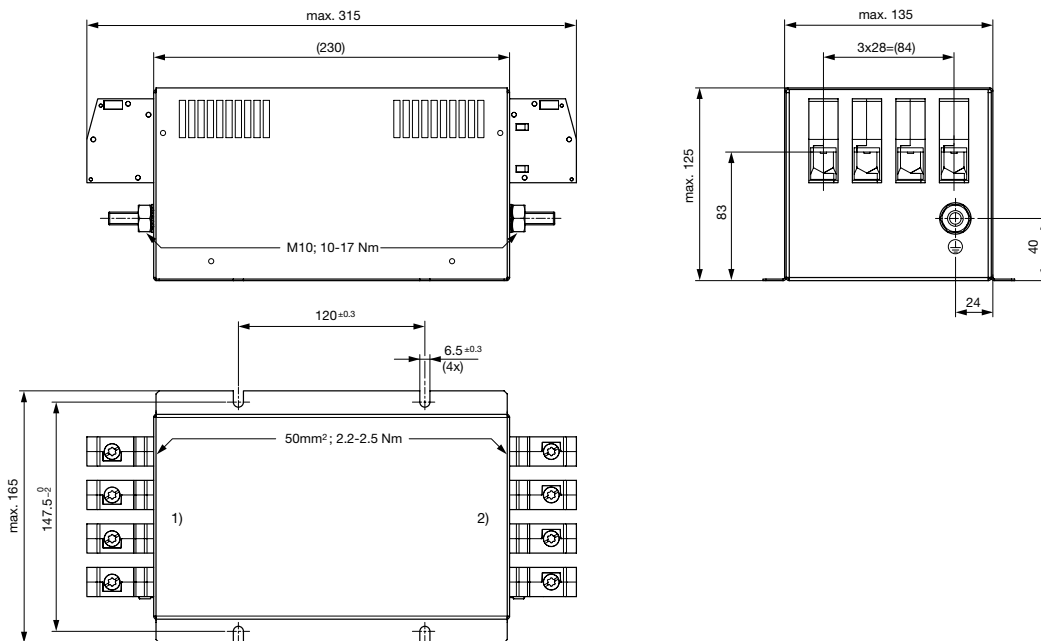

- 1) Line
- 2) Load

Case 2E

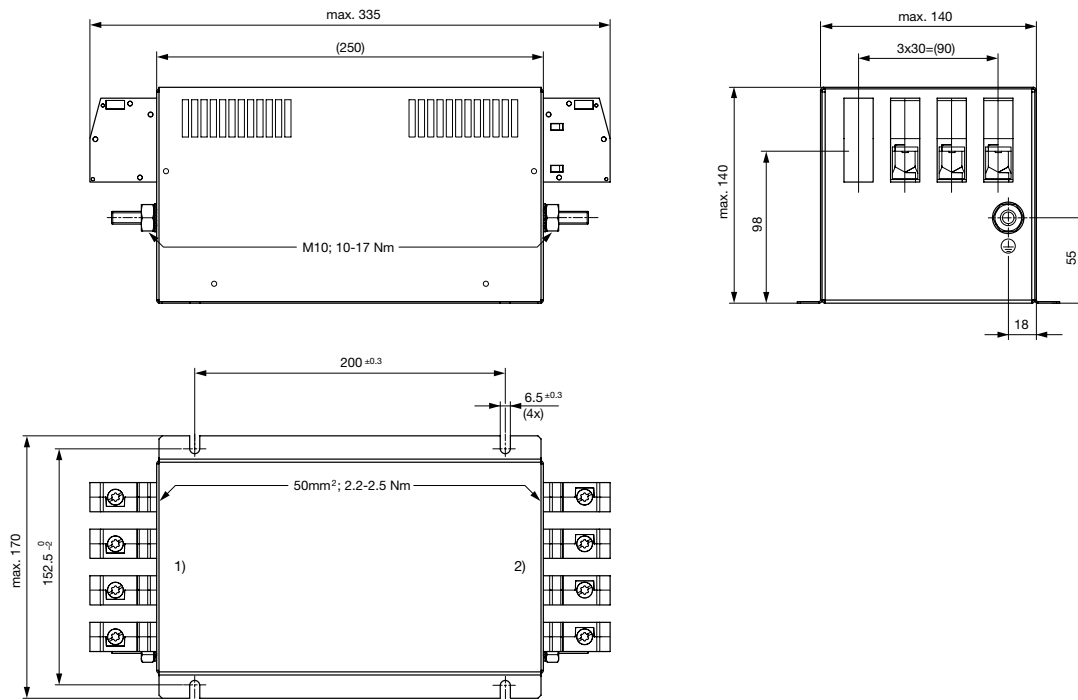

- 1) Line
- 2) Load

Case 2F

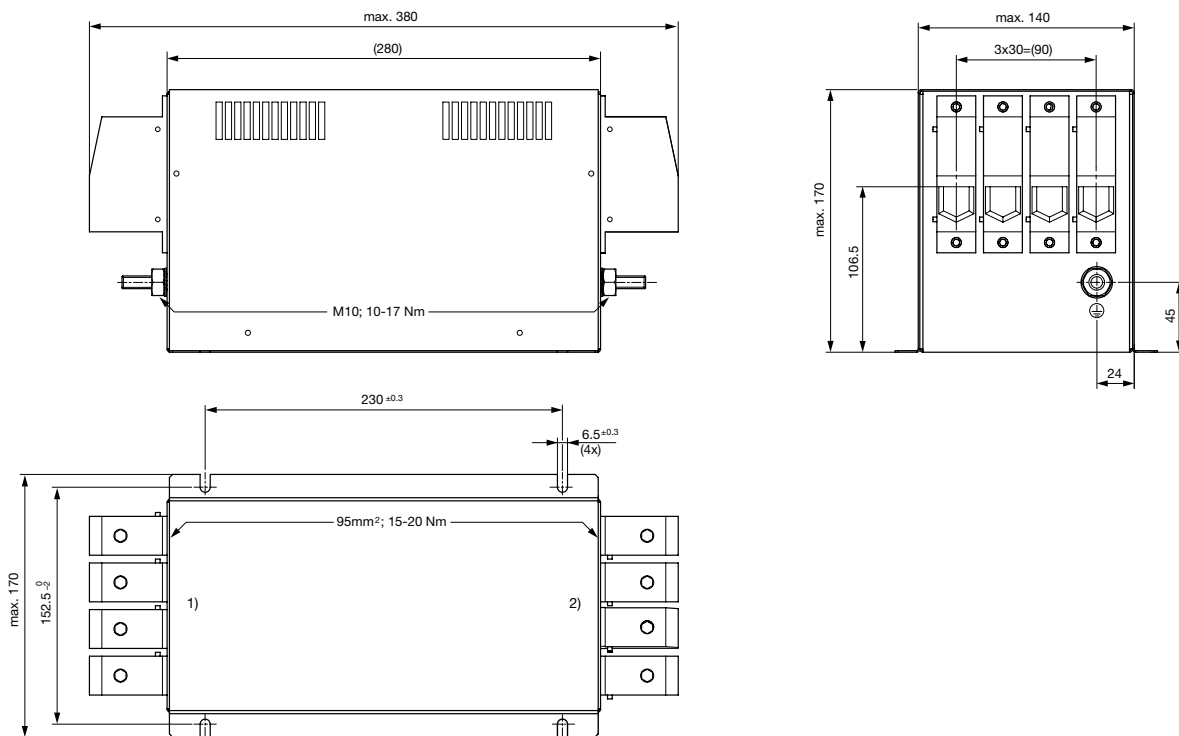

- 1) Line
- 2) Load

Technical data to the filter components

Rated Current @ Ta 50°C (75°C) [A]	L1 [mH]	L2 [μH]	C1 [μF]	C2 [μF]	C3 [μF]	R1 [MΩ]	R2 [MΩ]	R3 [MΩ]
8 (5)	2	4	2.2	2.2	3.4	-	1	2
16 (11)	1.3	12	2.2	2.2	3.4	-	1	2
25 (16)	1.6	12	4.7	4.7	3.4	1	1	2
36 (21)	1	12	4.7	4.7	3.4	1	1	2
64 (40)	0.7	7.5	4.7	4.7	3.4	1	1	2
80 (50)	0.6	9	8.2	8.2	3.4	1	1	2
120 (96)	0.6	9	13.6	13.6	3.4	0.5	0.5	2
160 (100)	0.4	9	13.6	13.6	3.4	0.5	0.5	2
200 (140)	0.3	9	13.6	13.6	3.4	0.5	0.5	2

Diagrams

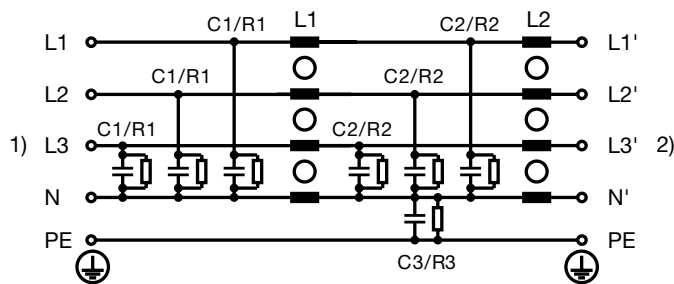

- 1) Line
- 2) Load

Derating Curves

Permissible Working Current as a Function of Ambient Temperature

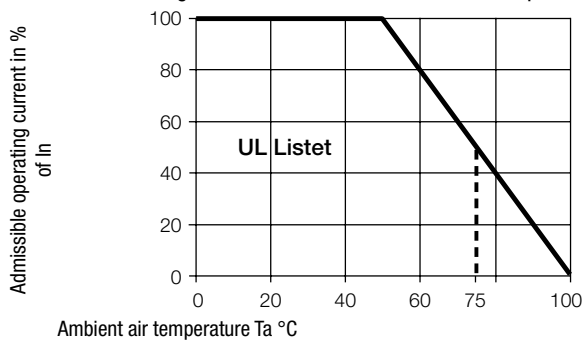

Attenuation Loss

Industrial Version

7A

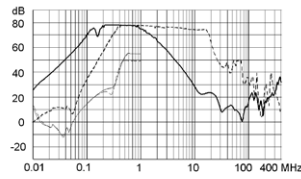

..... 01/100 differential mode 100/0.1 differential mode - - - - differential mode ____ common mode

16A

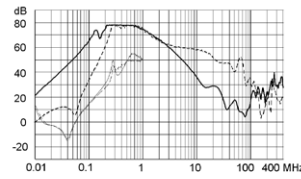

25A

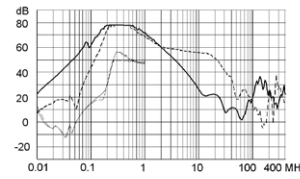

36A

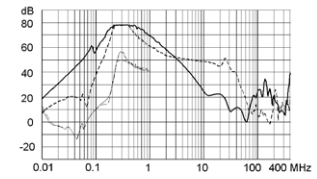

64A

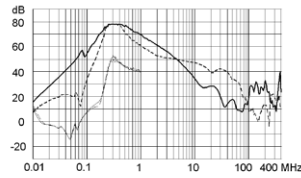

80A

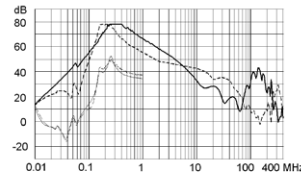

120A

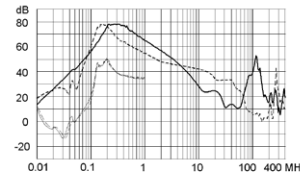

160A

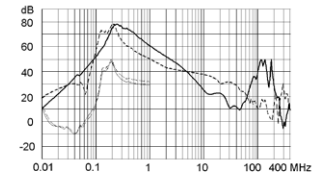

200A

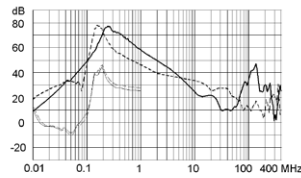

Variants

Rated Current @ Ta 50°C (75°C) [A]	Tripped Power Dissipation [W]	Contact Resistance [mΩ]	Leakage Current [mA] ¹⁾	Weight [kg]	Screw clamps [mm ²] ²⁾	Housing	Packaging unit [PCS]	Order Number
8 (5)	3.2	12.5	< 1	1.1	4	2A	2	FMBD-B92A-0812
16 (11)	7	6.8	< 1	1.2	4	2A	2	FMBD-B92A-1612
25 (16)	9.5	3.8	< 1	1.8	10	2B	2	FMBD-B92A-2512
36 (21)	12.5	2.4	< 1	2	10	2B	2	FMBD-B92B-3612
64 (40)	21.3	1.3	< 1	2.8	25	2C	1	FMBD-B92C-6412
80 (50)	22.6	0.88	< 1	5.7	50	2D	1	FMBD-B92D-8012
120 (96)	43.2	0.75	< 1	6.3	50	2E	1	FMBD-B92E-J212
160 (100)	37.9	0.37	< 1	8	95	2F	1	FMBD-B92F-J612
200 (140)	41.6	0.26	< 1	8.6	95	2F	1	FMBD-B92F-K012

1) Maximum leakage current under normal operating conditions, assuming that all three phases and the neutral conductor are connected to the supply and the consumer. Under this condition, the current will mainly return through the neutral line, not as earth leakage.

2) Maximum conductor cross section (wire gauge) to be used; a comparative table for AWG and mm² values can be found in the general product information www.schurter.com/emc_info