

# POWERTIP TECH. CORP.

## SPECIFICATIONS

CUSTOMER : CUS007



SAMPLE CODE (Ver.) : PS240128WRF-001H01 (VER.0)

MASS PRODUCTION CODE (Ver.) : PE240128WRF-001-HQ (VER.0)

DRAWING NO. (Ver.) : PE-05008-002 (VER.0)

**Customer Approved**

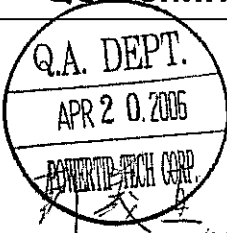
Date:

Approved	QC Confirmed	Designer
		 

Approval For Specifications Only.

\* This specification is subject to change without notice.

Please contact Powertip or it's representative before designing your product based on this specification.

Approval For Specifications and Sample.

## POWERTIP TECH. CORP.

### Headquarters:

No.8, 6<sup>th</sup> Road, Taichung Industrial Park,  
 Taichung, Taiwan  
 台中市 407 工業區六路 8 號

TEL: 886-4-2355-8168

FAX: 886-4-2355-8166

E-mail: [sales@powertip.com.tw](mailto:sales@powertip.com.tw)

Http://www.powertip.com.tw



## **Contents**

### **1. SPECIFICATIONS**

- 1.1 Features**
- 1.2 Mechanical Specifications**
- 1.3 Absolute Maximum Ratings**
- 1.4 DC Electrical Characteristics**
- 1.5 Optical Characteristics**
- 1.6 Backlight Characteristics**

### **2. MODULE STRUCTURE**

- 2.1 Counter Drawing**
- 2.2 Interface Pin Description**
- 2.3 Timing Characteristics**
- 2.4 Display Command**

### **3. QUALITY ASSURANCE SYSTEM**

- 3.1 Quality Assurance Flow Chart**
- 3.2 Inspection Specification**

### **4. RELIABILITY TEST**

- 4.1 Reliability Test Condition**

### **5. PRECAUTION RELATING PRODUCT HANDLING**

- 5.1 Safety**
- 5.2 Handling**
- 5.3 Storage**
- 5.4 Terms of Warranty**

**Appendix A : LCM Drawing**

**Appendix B : Package**

**Note : For detailed information please refer to IC data sheet : Sitronix --- ST7529-G**

## 1. SPECIFICATIONS

### 1.1 Features

Item	Standard Value
Display Type	240 * 128 Dots
LCD Type	FSTN , Positive , Transflective
Driver Condition	LCD Module : 1/160 Duty , 1/10 Bias
Viewing Direction	6 O'clock
Backlight Type	LED B/L
Weight	50 g
Interface	Support 8 Bit Parallel interface with 8080 or 6800 series MPU & IIC serial interface
Driver IC	SITRONIX - ST7529-G

### 1.2 Mechanical Specifications

Item	Standard Value	Unit
Outline Dimension	99.2 (L) * 64.2 (w) * 18.04 (H)(Max)	mm
Viewing Area	93.0 (L) * 49.0 (w)	mm
Active Area	82.775 (L) * 44.135 (w)	mm
Dot Size	0.32 (L) * 0.32 (w)	mm
Dot Pitch	0.345 (L) * 0.345 (w)	mm

Note : For detailed information please refer to LCM drawing

### 1.3 Absolute Maximum Ratings

Item	Symbol	Condition	Min.	Max.	Unit
Power Supply Voltage	$V_{DD}$	-	-0.5	5.0	V
LCD Driver Supply Voltage	$V_{LCD} - V_{SS}$	-	-0.5	+22	V
Input Voltage	$V_{IN}$	-	-0.5	$V_{DD} + 0.5$	V
Operating Temperature	$T_{OP}$	-	-20	70	°C
Storage Temperature	$T_{ST}$	-	-30	80	°C
Storage Humidity	$H_D$	$T_a < 40\text{ °C}$	20	90	%RH

## 1.4 DC Electrical Characteristics

$V_{DD} = 3.3 \text{ V} \pm 0.3$ ,  $V_{SS} = 0 \text{ V}$ ,  $T_a = 25^\circ\text{C}$

Item	Symbol	Condition	Min.	Typ.	Max.	Unit
Logic Supply Voltage	$V_{DD}$	-	3.0	3.3	3.6	V
High-level Input Voltage	$V_{IH}$	-	$0.7V_{DD}$	-	$V_{DD}$	V
Low-level Input Voltage	$V_{IL}$	-	$V_{SS}$	-	$0.3V_{DD}$	V
High-level Output Voltage	$V_{OH}$	-	-	-	-	V
Low-level Output Voltage	$V_{OL}$	-	-	-	-	V
Supply Current	$I_{DD}$	$V_{DD} = 3.3 \text{ V}$	-	1.2	6.2	mA
LCM Driver Voltage	$V_{OP}$	$V_o - V_{SS} (-20^\circ\text{C})$	14.0	14.1	14.2	V
	$V_{OP}$	$V_o - V_{SS} (25^\circ\text{C}) *1$	12.8	12.95	13.1	V
	$V_{OP}$	$V_o - V_{SS} (70^\circ\text{C})$	11.7	11.8	11.9	V

NOTE:\*1 The VOP test point is  $V_o - V_{SS}$ .

NOTE:2 :Recommended Power Supply Combinations.

User setup	Power control (VB VR VF)	V/B circuits	V/R circuits	V/F circuits	VLCD	V0	V1 to V4
Only the internal power supply circuits are used	1 1 1	ON	ON	ON	Open	Open	Open
Only the voltage regulator circuits and voltage follower circuits are used	0 1 1	OFF	ON	ON	External input	Open	Open
Only the voltage follower circuits are used	0 0 1	OFF	OFF	ON	Open	External input	Open
Only the external power supply circuits are used	0 0 0	OFF	OFF	OFF	Open	External input	External input

## 1.5 Optical Characteristics

LCD Panel: 1/160 Duty, 1/13 Bias,  $V_{LCD} = 15.06 \text{ V}$   $T_a = 25^\circ\text{C}$

Item	Symbol	Conditions	Min.	Typ.	Max.	Reference
View Angle	$\theta$	$C \geq 2.0$ , $\varnothing = 270^\circ$	$-40^\circ$	-	$+40^\circ$	Note 1
Contrast Ratio	CR	$\theta = -5^\circ$ , $\varnothing = 270^\circ$	2	2.8	-	Note 3
Response Time(rise)	$T_r$	$\theta = -5^\circ$ , $\varnothing = 270^\circ$	-	135 ms	205 ms	Note 2
Response Time(fall)	$T_f$	$\theta = -5^\circ$ , $\varnothing = 270^\circ$	-	300 ms	450 ms	

Note 1.

Optical characteristics-2

Viewing angle

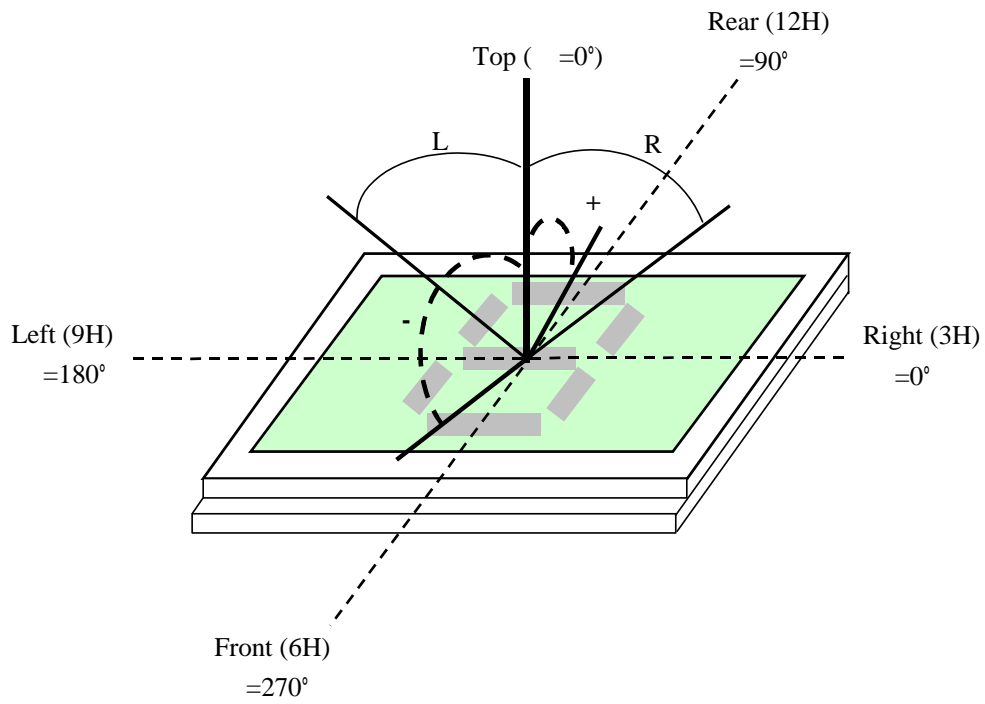

**Viewing angle**

Note 2.

Optical characteristics-3

Fig.2 Definition of response time

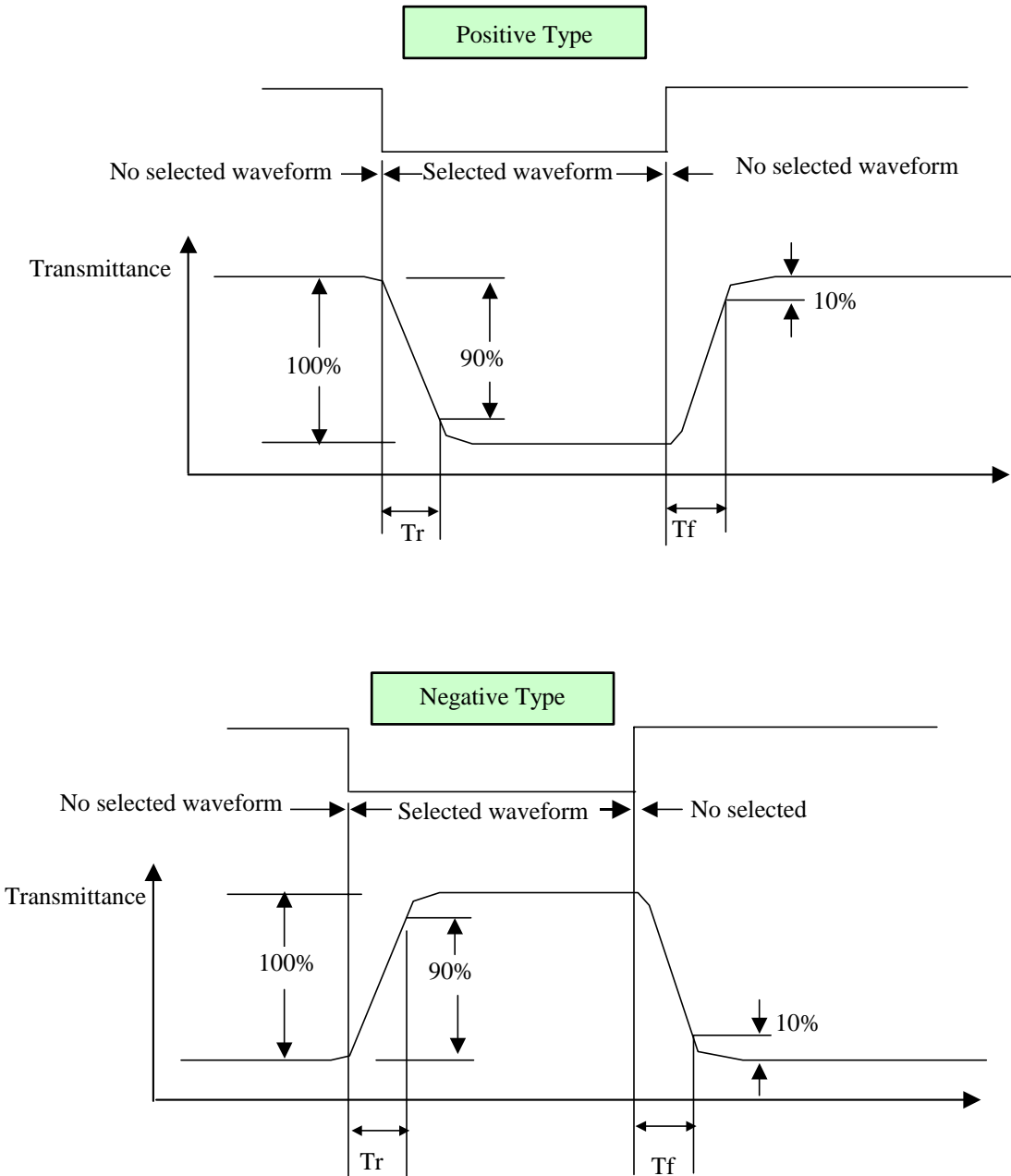

Electrical characteristics-2

2 Drive waveform

$V_{op}$ : Drive voltage       $f_F$ : Frame frequency  
 $1/B$ : Bias                       $f_D$ : Drive frequency  
 $N$ : Duty

(1) Selected waveform

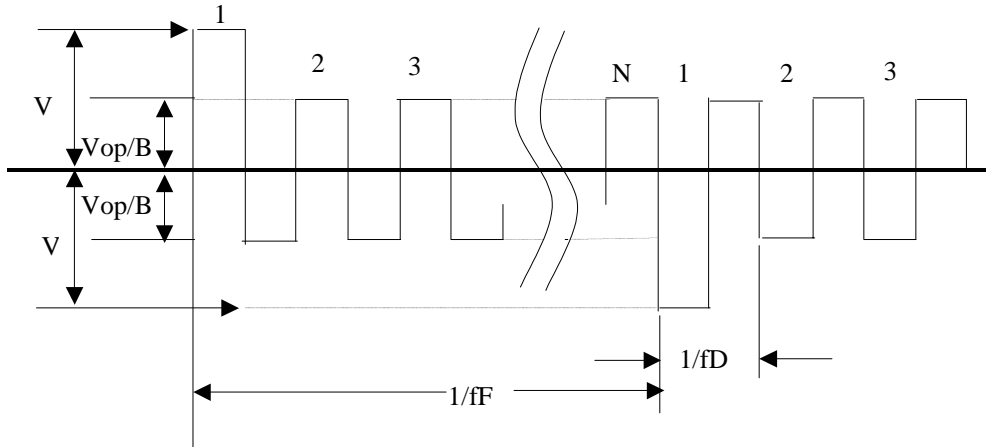

(2) Non- Selected waveform

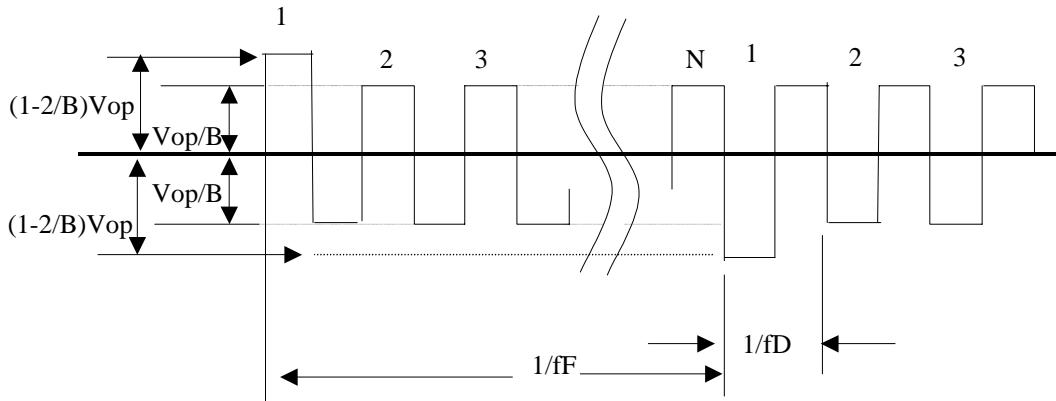

Note:

Frame frequency is defined as follows: Common side supply voltage peak - to - peak / 2 = 1 period



Note 3. : Definition of Vth

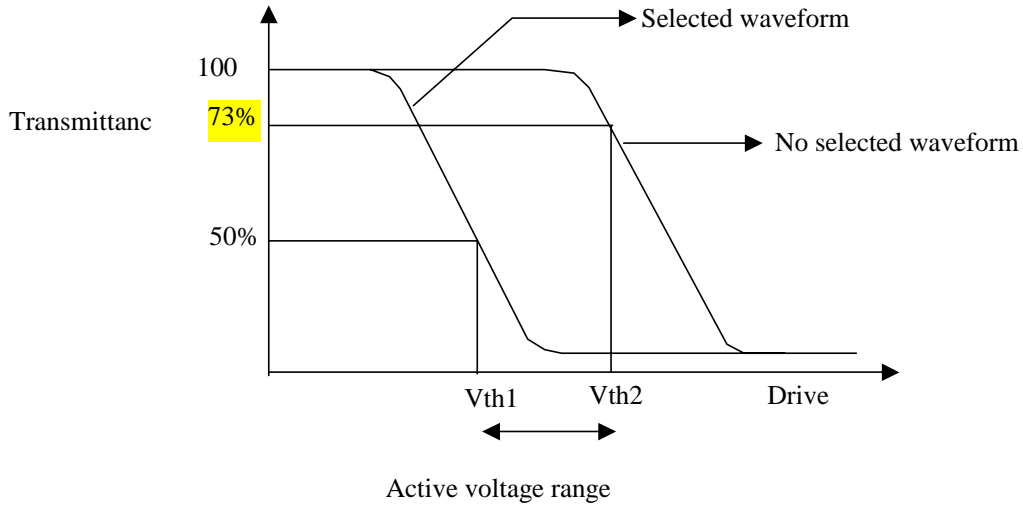

	Vth1	Vth2
View direction	10°	40°
Drive waveform	(Selected waveform)	(No selected waveform)
Transmittance	50%	73%

1 Contrast ratio  
 = (Brightness in OFF state) / (Brightness in ON state)

Outline of Electro-Optical Characteristics Measuring System

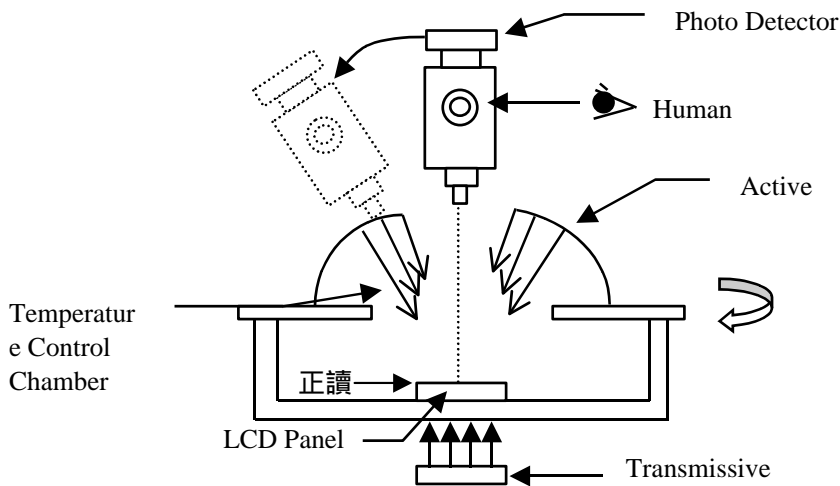

Measuring System: Autronic DMS-803

## 1.6 Backlight Characteristics

LCD Module with LED Backlight

### Maximum Ratings

Item	Symbol	Conditions	Min.	Max.	Unit
Forward Current	IF	Ta =25	-	180	mA
Reverse Voltage	VR	Ta =25	-	5	V
Power Dissipation	PO	Ta =25	-	0.61	W

### Electrical / Optical Characteristics

Ta =25

Item	Symbol	Conditions	Min.	Typ.	Max.	Unit
Forward Voltage	VF	IF= 80 mA	-	3.3	3.4	V
Reverse Current	IR	VR= 5V	-	-	60	uA
CIE Color Coordinate (With LCD)	X	IF= 80 mA	0.29	0.32	0.35	-
	Y		0.35	0.38	0.41	
Average Brightness (with LCD) *1	IV	IF= 80 mA	30	50	-	cd/m <sup>2</sup>
Uniformity (With LCD)*2	B	IF= 80 mA	70	-	-	%
Color	White					

\*1 This value will be changed while mass production.

\*2 :  $B=B(\min) / B(\max)$

## 2. MODULE STRUCTURE

### 2.1 Counter Drawing

#### 2.1.1 LCM Mechanical Diagram

\* See Appendix

#### 2.1.2 Block Diagram

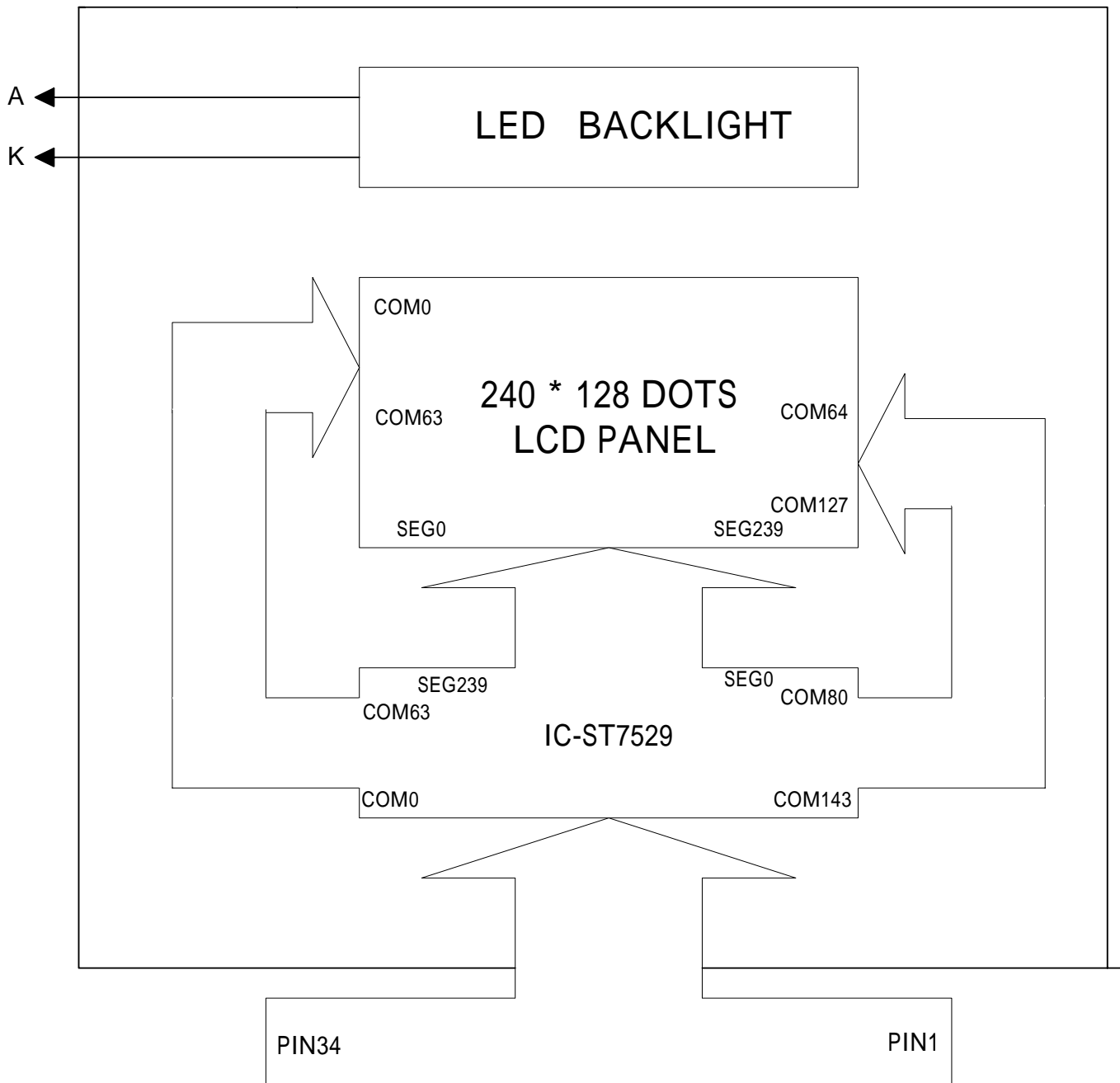

Please refer interface pin description for detail

## 2.2 Interface Pin Description

Pin No.	Symbol	Function								
1	A0	Register select input pin – A0 = "H": DB0 to DB8 or SI are display data – A0 = "L": DB0 to DB8 or SI are control data								
2	RW_WR	Read / Write execution control pin								
		MPU Type	RW_WR	Description	6800	RW	Read / Write control input pin RW = "H" : read RW = "L" : write	8080	/WR	Write enable clock input pin The data on DB0 to DB8 are latched at the rising edge of the /WR signal.
		MPU Type	RW_WR	Description						
6800	RW	Read / Write control input pin RW = "H" : read RW = "L" : write								
8080	/WR	Write enable clock input pin The data on DB0 to DB8 are latched at the rising edge of the /WR signal.								
3	DB0	They connect to the standard 8-bit MPU bus via the 8 bit bi-directional bus. When the following interface is selected and the XCS pin is high, the following pins become high impedance, which should be fixed to VDD or VSS.								
4	DB1									
5	DB2									
6	DB3									
7	DB4	In IIC Interface								
8	DB5	D7: SCL; D6: SI ; D0, D1: SA1, SA0								
9	DB6	D3, D2: Acknowledgement								
10	DB7	D4, D5, D8 should be fixed to VDD or VSS.								
11	E_RD	Read / Write execution control pin								
		MPU Type	RW_WR	Description	6800	E	Read / Write control input pin -RW = "H": When E is "H", DB0 to DB8 are in an output status. -RW = "L": The data on DB0 to DB8 are latched at the falling edge of the E signal.	8080	/RD	Read enable clock input pin When /RD is "L", DB0 to DB8 are in an output status.
		MPU Type	RW_WR	Description						
6800	E	Read / Write control input pin -RW = "H": When E is "H", DB0 to DB8 are in an output status. -RW = "L": The data on DB0 to DB8 are latched at the falling edge of the E signal.								
8080	/RD	Read enable clock input pin When /RD is "L", DB0 to DB8 are in an output status.								
12	RST	Reset input pin. When RST is "L", initialization is executed.								

Pin No.	Symbol	Function		
13	IF1	IF1	IF3	MPU interface type
		H	L	80 series 8-bit parallel
14	IF3	L	H	68 series 8-bit parallel
		L	L	IIC
15	XCS	Chip select input pins Data/instruction I/O is enabled only when XCS is "L". When chip select is non-active, DB0 to DB8 may be high impedance.		
16	VSS	Power supply (VSS=0)		
17	VDD	Power supply (VDD=3.3V)		
18	CAP7P	DC / DC voltage converter. Connect a capacitor between this terminal and the CAP7P terminal.		
19	CAP1N	DC / DC voltage converter. Connect a capacitor between this terminal and the CAP1N terminal.		
20	CAP5P	DC / DC voltage converter. Connect a capacitor between this terminal and the CAP5P terminal.		
21	CAP3P	DC / DC voltage converter. Connect a capacitor between this terminal and the CAP3P terminal.		
22	CAP1N	DC / DC voltage converter. Connect a capacitor between this terminal and the CAP1N terminal.		
23	CAP1P	DC / DC voltage converter. Connect a capacitor between this terminal and the CAP1P terminal.		
24	CAP2P	DC / DC voltage converter. Connect a capacitor between this terminal and the CAP2P terminal.		
25	CAP2N	DC / DC voltage converter. Connect a capacitor between this terminal and the CAP2N terminal.		
26	CAP4P	DC / DC voltage converter. Connect a capacitor between this terminal and the CAP4P terminal.		
27	CAP2N	DC / DC voltage converter. Connect a capacitor between this terminal and the CAP2N terminal.		
28	CAP6P	DC / DC voltage converter. Connect a capacitor between this terminal and the CAP6P terminal.		
29	VLCD	LCD supply voltage		

Pin No.	Symbol	Function										
30	V4	LCD driver supply voltages V0In & V0out should be connected together in FPC area.										
31	V3	Voltages should have the following relationship: V0 V1 V2 V3 V4 VSS										
32	V2	When the internal power circuit is active, these voltages are generated as the following table according to the state of LCD bias.										
33	V1	<table border="1"> <thead> <tr> <th>LCD Bias</th> <th>V1</th> <th>V2</th> <th>V3</th> <th>V4</th> </tr> </thead> <tbody> <tr> <td>1/N Bias</td> <td><math>(N-1) / N \times V0</math></td> <td><math>(N-2) / N \times V0</math></td> <td><math>(2/N) \times V0</math></td> <td><math>(1/N) \times V0</math></td> </tr> </tbody> </table>	LCD Bias	V1	V2	V3	V4	1/N Bias	$(N-1) / N \times V0$	$(N-2) / N \times V0$	$(2/N) \times V0$	$(1/N) \times V0$
		LCD Bias	V1	V2	V3	V4						
1/N Bias	$(N-1) / N \times V0$	$(N-2) / N \times V0$	$(2/N) \times V0$	$(1/N) \times V0$								
NOTE: N = 5 to 14												
34	V0											

## 2.3 Timing Characteristics

### For the 8080 Series MPU

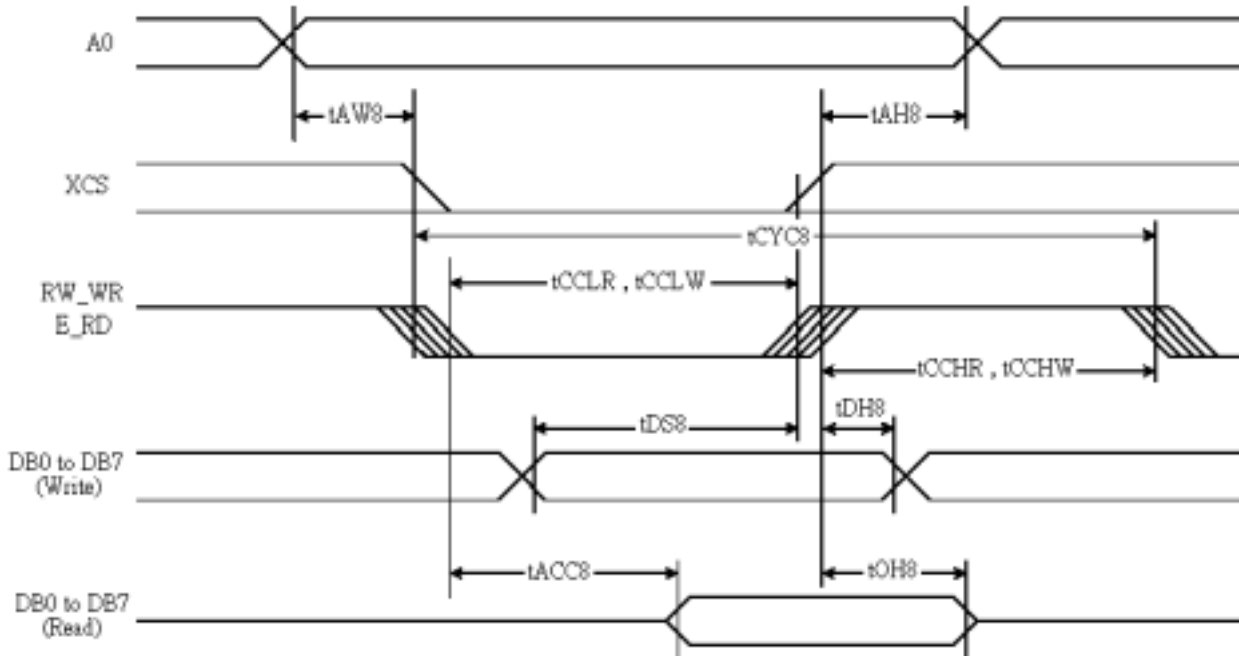

$V_{DD} = 3.3V$ ,  $T_a = 25^\circ C$

Item	Signal	Symbol	Condition	Rating		Units
				Min	Max	
Address hold time	A0	$t_{AH8}$	-	20	-	ns
Address setup time		$t_{AW8}$	-	20	-	
System cycle time		$t_{CYC8}$	-	200	-	
Enable L pulse width (Write)	RW_WR	$t_{CCLW}$	-	100	-	
Enable H pulse width (Write)		$t_{CCHW}$	-	100	-	
Enable L pulse width (Read)	E_RD	$t_{CCLR}$	-	100	-	
Enable H pulse width (Read)		$t_{CCHR}$	-	100	-	
WRITE Data setup time	DB0 to DB7	$t_{DS8}$	-	150	-	
WRITE Address hold time		$t_{DH8}$	-	20	-	
READ access time		$t_{ACC8}$	$C_L = 100pF$	-	40	
READ Output disable time		$t_{OH8}$	$C_L = 100pF$	-	30	

## For the 6800 Series MPU

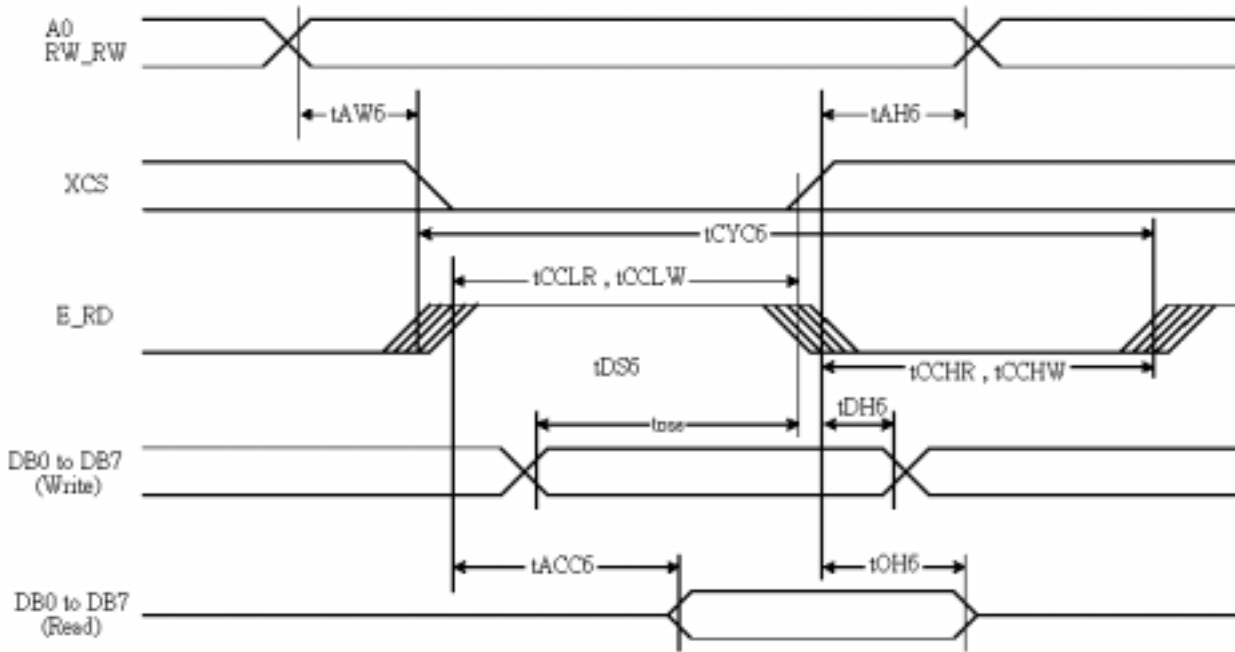

$V_{DD} = 3.3V, T_a = 25^{\circ}C$

Item	Signal	Symbol	Condition	Rating		Units
				Min	Max	
Address hold time	A0	$t_{AH6}$	-	20	-	ns
Address setup time		$t_{AW6}$	-	20	-	
System cycle time		$t_{CYC6}$	-	200	-	
Enable L pulse width (Write)	RW_WR	$t_{EWLW}$	-	100	-	
Enable H pulse width (Write)		$t_{EWHW}$	-	100	-	
Enable L pulse width (Read)	E_RD	$t_{EWLR}$	-	100	-	
Enable H pulse width (Read)		$t_{EWHR}$	-	100	-	
WRITE Data setup time	DB0 to DB7	$t_{DS6}$	-	150	-	
WRITE Address hold time		$t_{DH6}$	-	20	-	
READ access time		$t_{ACC6}$	$C_L = 100pF$	-	40	
READ Output disable time		$t_{OH6}$	$C_L = 100pF$	-	30	



## Reset Timing

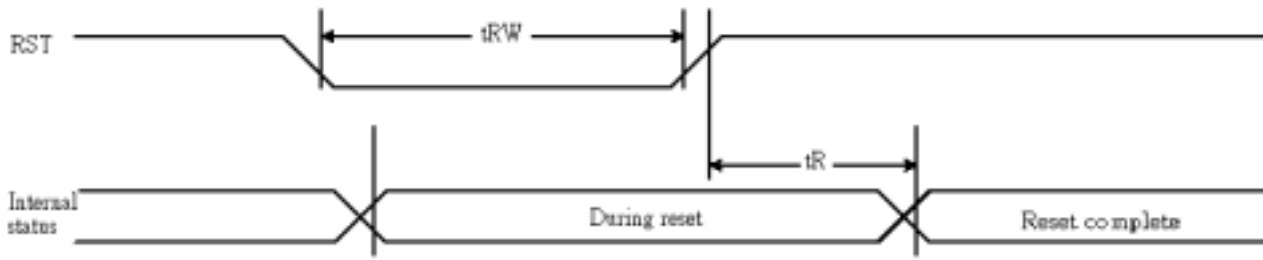

$V_{DD} = 3.3V$ ,  $T_a = 25^{\circ}C$

Item	Signal	Symbol	Condition	Rating			Units
				Min	Typ	Max	
Reset time	-	$t_R$	-	-	-	1	$\mu s$
Reset "L" pulse width	RES	$t_{RW}$	-	1	-	-	$\mu s$

## 2.4 Display Command

### Ext=0 or Ext=1

Index	Command	A0	RD	WR	D7	D6	D5	D4	D3	D2	D1	D0	Function
1	Ext In	0	1	0	0	0	1	1	0	0	0	0	Ext=0 Set
2	Ext Out	0	1	0	0	0	1	1	0	0	0	1	Ext=1 Set

### Ext=0

Index	Command	A0	RD	WR	D7	D6	D5	D4	D3	D2	D1	D0	Function
1	DISON	0	1	0	1	0	1	0	1	1	1	1	Display On
2	DISOFF	0	1	0	1	0	1	0	1	1	1	0	Display Off
3	DISNOR	0	1	0	1	0	1	0	0	1	1	0	Normal Display
4	DISINV	0	1	0	1	0	1	0	0	1	1	1	Inverse Display
5	COMSCN	0	1	0	1	0	1	1	1	0	1	1	COM Scan Direction
6	DISCTRL	0	1	0	1	1	0	0	1	0	1	0	Display Control
7	SLPIN	0	1	0	1	0	0	1	0	1	0	1	Sleep In
8	SLPOUT	0	1	0	1	0	0	1	0	1	0	0	Sleep Out
9	LASET	0	1	0	0	1	1	1	0	1	0	1	Line Address Set
10	CASET	0	1	0	0	0	0	1	0	1	0	1	Column Address Set
11	DATSDR	0	1	0	1	0	1	1	1	1	0	0	Data Scan Direction
12	RAMWR	0	1	0	0	1	0	1	1	1	0	0	Writing to Memory
13	RAMRD	0	1	0	0	1	0	1	1	1	0	1	Reading from Memory
14	PTLIN	0	1	0	1	0	1	0	1	0	0	0	Partial display in
15	PTLOUT	0	1	0	1	0	1	0	1	0	0	1	Partial display out
16	RMWIN	0	1	0	1	1	1	0	0	0	0	0	Read and Modify Write
17	RMWOUT	0	1	0	1	1	1	0	1	1	1	0	RMW end
18	ASCSET	0	1	0	1	0	1	0	1	0	1	0	Area Scroll Set
19	SCSTART	0	1	0	1	0	1	0	1	0	1	1	Scroll Start Set

20	OSCON	0	1	0	1	1	0	1	0	0	0	1	Internal OSC on
21	OSCOFF	0	1	0	1	1	0	1	0	0	1	0	Internal OSC off
22	PWRCTRL	0	1	0	0	0	1	0	0	0	0	0	Power Control
23	VOLCTRL	0	1	0	1	0	0	0	0	0	0	1	EC control
24	VOLUP	0	1	0	1	1	0	1	0	1	1	0	EC increase 1
25	VOLDOWN	0	1	0	1	1	0	1	0	1	1	1	EC decrease 1
26	RESERVED	0	1	0	1	0	0	0	0	0	1	0	Not Use
27	EPSRRD1	0	1	0	0	1	1	1	1	1	0	0	READ Register1

28	EPSRRD2	0	1	0	0	1	1	1	1	1	0	1	READ Register2
29	NOP	0	1	0	0	0	1	0	0	1	0	1	NOP Instruction
30	STREAD	0	0	1	Read Data							Status Read	
31	EPINT	0	1	0	0	0	0	0	0	1	1	1	Initial code(1)

**Ext=1**

Index	Command	A0	RD	WR	D7	D6	D5	D4	D3	D2	D1	D0	Function
1	Gray 1 Set	0	1	0	0	0	1	0	0	0	0	0	FRAME 1 Gray PWM Set
2	Gray 2 Set	0	1	0	0	0	1	0	0	0	0	1	FRAME 2 Gray PWM Set
3	Wt. Set	0	1	0	0	0	1	0	0	0	1	0	Weight Set
4	ANASET	0	1	0	0	0	1	1	0	0	1	0	Analog Circuit Set
5	DITHOFF	0	1	0	0	0	1	1	0	1	0	0	Dithering Circuit Off
6	DITHON	0	1	0	0	0	1	1	0	1	0	1	Dithering Circuit On
7	EPCTIN	0	1	0	1	1	0	0	1	1	0	1	Control EEPROM
8	EPCOUT	0	1	0	1	1	0	0	1	1	0	0	Cancel EEPROM
9	EPMWR	0	1	0	1	1	1	1	1	1	0	0	Write to EEPROM
10	EPMRD	0	1	0	1	1	1	1	1	1	0	1	Read from EEPROM

### 3. QUALITY ASSURANCE SYSTEM

#### 3.1 Quality Assurance Flow Chart

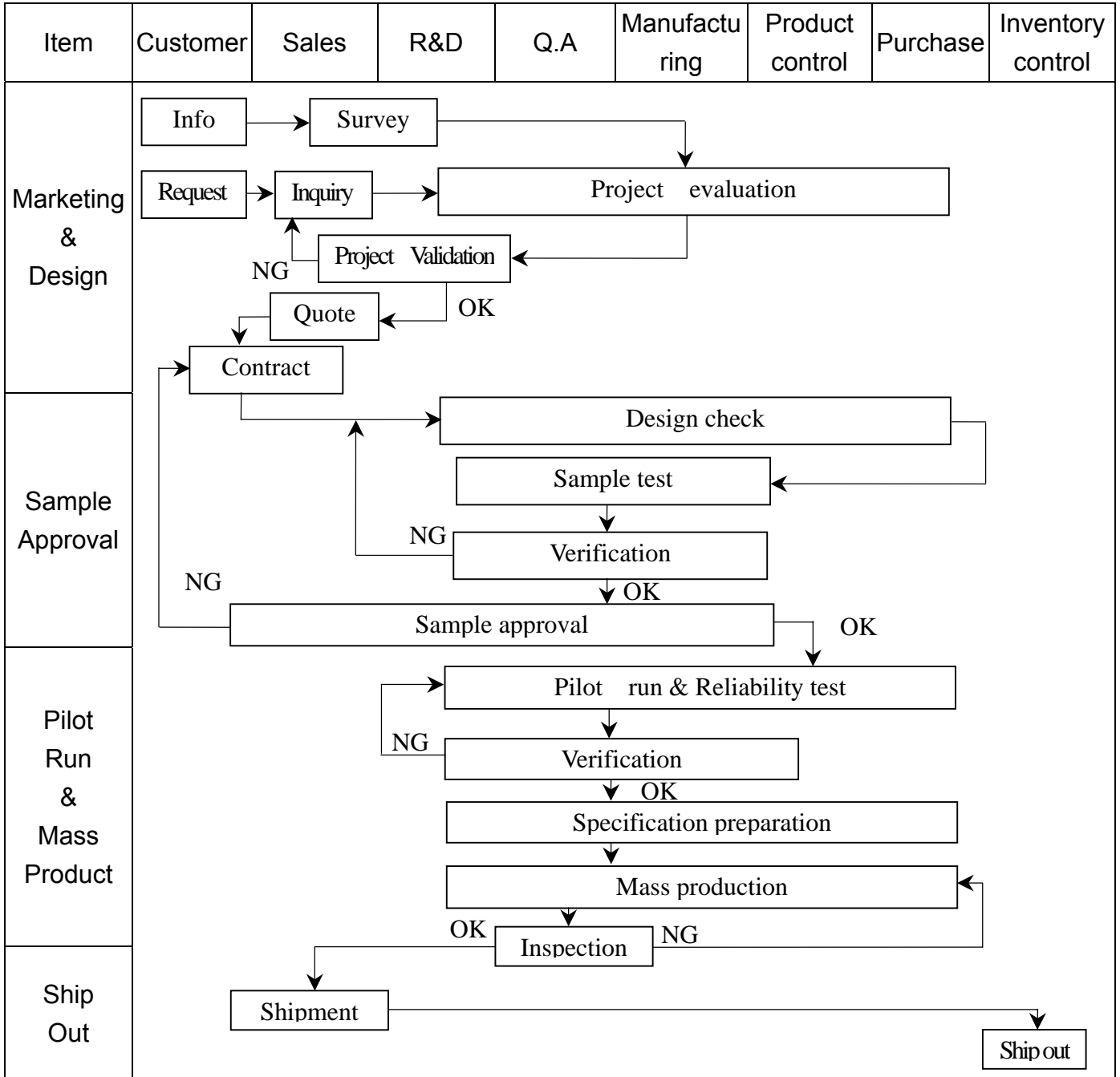

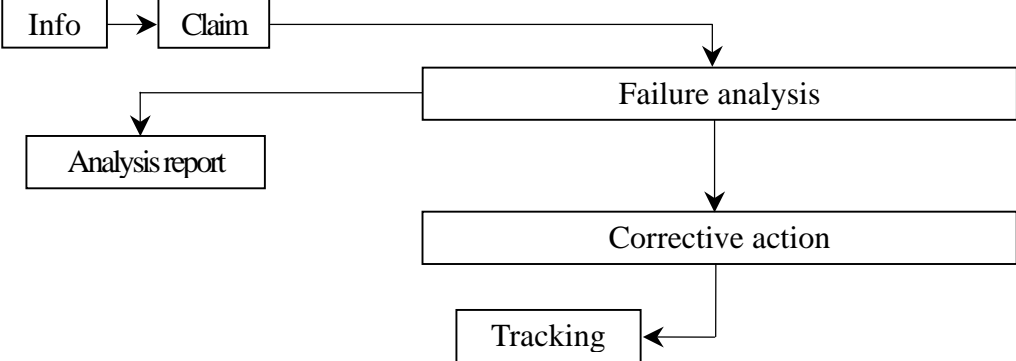
Item	Customer	Sales	R&D	Q.A	Manufacturing	Product control	Purchase	Inventory control
Sales Service	 <pre> graph TD     Info[Info] --&gt; Claim[Claim]     Claim --&gt; Failure[Failure analysis]     Failure --&gt; Report[Analysis report]     Failure --&gt; Action[Corrective action]     Action --&gt; Tracking[Tracking]           </pre>							
Q.A Activity	1. ISO 9001 Maintenance Activities 3. Equipment calibration 5. Standardization Management				2. Process improvement proposal 4. Education And Training Activities			

### 3.2 Inspection Specification

Inspection Standard : MIL-STD-105E Table Normal Inspection Single Sampling Level II

Equipment : Gauge , MIL-STD , Powertip Tester , Sample

IQC Defect Level : Major Defect AQL 0.4; Minor Defect AQL 1.5

FQC Defect Level : 100% Inspection

OUT Going Defect Level : Sampling

Specification :

NO	Item	Specification	Judge	Level
1	Part Number	The part number is inconsistent with work order of production	N.G.	Major
2	Quantity	The quantity is inconsistent with work order of production	N.G.	Major
3	Electronic characteristics of LCM A=( L + W ) 2	The display lacks of some patterns.	N.G.	Major
		Missing line.	N.G.	Major
		The size of missing dot, A is > 1/2 Dot size	N.G.	Major
		There is no function.	N.G.	Major
		Output data is error	N.G.	Major
4	Appearance of LCD A=( L + W ) 2	Material is different with work order of production	N.G.	Major
		LCD is assembled in inverse direction	N.G.	Major
		Bezel is assembled in inverse direction	N.G.	Major
		Shadow is within LCD viewing area + 0.5 mm	N.G.	Major
		The diameter of dirty particle, A is > 0.4 mm	N.G.	Minor
	Dirty particle (Including scratch、bubble )	Dirty particle length is > 3.0mm, and 0.01mm < width ≤ 0.05mm	N.G.	Minor
		Display is without protective film	N.G.	Minor
		Conductive rubber is over bezel 1mm	N.G.	Minor
		Polarizer exceeds over viewing area of LCD	N.G.	Minor
		Area of bubble in polarizer, A > 1.0mm, the number of bubble is > 1 piece.	N.G.	Minor
		0.4mm < Area of bubble in polarizer, A < 1.0mm, the number of bubble is > 4 pieces.	N.G.	Minor
5	Appearance of PCB A=( L + W ) 2	Burned area or wrong part number is on PCB	N.G.	Major
		The symbol, character, and mark of PCB are unidentifiable.	N.G.	Minor
		The stripped solder mask , A is > 1.0mm	N.G.	Minor
		0.3mm < stripped solder mask or visible circuit, A < 1.0mm, and the number is ≥ 4 pieces	N.G.	Minor
		There is particle between the circuits in solder mask	N.G.	Minor
		The circuit is peeled off or cracked	N.G.	Minor
		There is any circuits risen or exposed.	N.G.	Minor
		0.2mm < Area of solder ball, A is ≤ 0.4mm	N.G.	Minor
		The number of solder ball is ≥ 3 pieces	N.G.	Minor
The magnitude of solder ball, A is > 0.4mm.	N.G.	Minor		

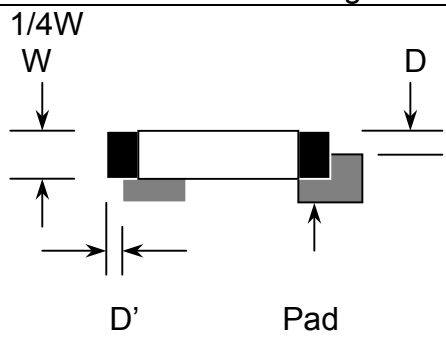
NO	Item	Specification	Judge	Level
6	Appearance of molding $A=(L+W)$ 2	The shape of modeling is deformed by touching.	N.G.	Major
		Insufficient epoxy: Circuit or pad of IC is visible	N.G.	Minor
		Excessive epoxy: Diameter of modeling is $> 20\text{mm}$ or height is $> 2.5\text{mm}$	N.G.	Minor
		The diameter of pinhole in modeling, A is $> 0.2\text{mm}$ .	N.G.	Minor
7	Appearance of frame $A=(L+W)$ 2	The folding angle of frame must be $> 45^\circ + 10^\circ$	N.G.	Minor
		The area of stripped electroplate in top-view of frame, A is $> 1.0\text{mm}$ .	N.G.	Minor
		Rust or crack is (Top view only)	N.G.	Minor
		The scratched width of frame is $> 0.06\text{mm}$ . (Top view only)	N.G.	Minor
8	Electrical characteristic of backlight $A=(L+W)$ 2	The color of backlight is nonconforming	N.G.	Major
		Backlight can't work normally.	N.G.	Major
		The LED lamp can't work normally	N.G.	Major
		The unsoldering area of pin for backlight, A is $> 1/2$ solder joint area.	N.G.	Minor
		The height of solder pin for backlight is $> 2.0\text{mm}$	N.G.	Minor
10	Assembly parts $A=(L+W)$ 2	The mark or polarity of component is unidentifiable.	N.G.	Minor
		The height between bottom of component and surface of the PCB is floating $> 0.7\text{mm}$	N.G.	Minor
		$D > 1/4W$  <p>The diagram illustrates a component on a PCB pad. W is the component width, D is the side overhang, and D' is the end solder joint width. The pad is labeled 'Pad'.</p>	N.G.	Minor
		End solder joint width, D' is $> 50\%$ width of component termination or width of pad	N.G.	Minor
		Side overhang, D is $> 25\%$ width of component termination.	N.G.	Minor
		Component is cracked, deformed, and burned, etc.	N.G.	Minor
		The polarity of component is placed in inverse direction.	N.G.	Minor
		Maximum fillet height of solder extends onto the component body or minimum fillet height is $< 0.5\text{mm}$ .	N.G.	Minor

## 4. RELIABILITY TEST

### 4.1 Reliability Test Condition

NO	Item	Test Condition	
1	High Temperature Storage	Storage at $80 \pm 2^{\circ}\text{C}$ 96~100 hrs Surrounding temperature, then storage at normal condition 4hrs	
2	Low Temperature Storage	Storage at $-30 \pm 2^{\circ}\text{C}$ 96~100 hrs Surrounding temperature, then storage at normal condition 4hrs	
3	High Temperature /Humidity Storage	1.Storage 96~100 hrs $60 \pm 2^{\circ}\text{C}$ , 90~95%RH surrounding temperature, then storage at normal condition 4hrs. (Excluding the polarizer).or 2.Storage 96~100 hrs $40 \pm 2^{\circ}\text{C}$ , 90~95%RH surrounding temperature, then storage at normal condition 4 hrs.	
4	Temperature Cycling	$-20^{\circ}\text{C} \rightarrow 25^{\circ}\text{C} \rightarrow 70^{\circ}\text{C} \rightarrow 25^{\circ}\text{C}$ $\leftarrow (30\text{mins}) (5\text{mins}) (30\text{mins}) (5\text{mins}) \rightarrow$ <p style="text-align: center;">10 Cycle</p>	
5	Vibration	10~55Hz ( 1 minute ) 1.5mm X,Y and Z direction * (each 2hrs)	
6	ESD Test	Air Discharge: Apply 6 KV with 5 times discharge for each polarity +/-	Contact Discharge: Apply 250V with 5 times discharge for each polarity +/-
		Testing location: Around the face of LCD	Testing location: 1.Apply to bezel. 2.Apply to Vdd, Vss.
7	Drop Test	Packing Weight (Kg)	Drop Height (cm)
		0 ~ 45.4	122
		45.4 ~ 90.8	76
		90.8 ~ 454	61
		Over 454	46



## 5. PRECAUTION RELATING PRODUCT HANDLING

### 5.1 SAFETY

- 5.1.1 If the LCD panel breaks , be careful not to get the liquid crystal to touch your skin.
- 5.1.2 If the liquid crystal touches your skin or clothes , please wash it off immediately by using soap and water.

### 5.2 HANDLING

- 5.2.1 Avoid any strong mechanical shock which can break the glass.
- 5.2.2 Avoid static electricity which can damage the CMOS LSI—When working with the module , be sure to ground your body and any electrical equipment you may be using.
- 5.2.3 Do not remove the panel or frame from the module.
- 5.2.4 The polarizing plate of the display is very fragile. So , please handle it very carefully, do not touch , push or rub the exposed polarizing with anything harder than an HB pencil lead (glass , tweezers , etc.)
- 5.2.5 Do not wipe the polarizing plate with a dry cloth , as it may easily scratch the surface of plate.
- 5.2.6 Do not touch the display area with bare hands , this will stain the display area.
- 5.2.7 Do not use ketonics solvent & aromatic solvent. Use with a soft cloth soaked with a cleaning naphtha solvent.
- 5.2.8 To control temperature and time of soldering is  $280 \pm 10^{\circ}\text{C}$  and 3-5 sec.
- 5.2.9 To avoid liquid (include organic solvent) stained on LCM

### 5.3 STORAGE

- 5.3.1 Store the panel or module in a dark place where the temperature is  $25^{\circ}\text{C} \pm 5^{\circ}\text{C}$  and the humidity is below 65% RH.
- 5.3.2 Do not place the module near organics solvents or corrosive gases.
- 5.3.3 Do not crush , shake , or jolt the module.

### 5.4 TERMS OF WARRANTY

#### 5.4.1 Applicable warrant period

The period is within thirteen months since the date of shipping out under normal using and storage conditions.

#### 5.4.2 Unaccepted responsibility

This product has been manufactured to your company's specification as a part for use in your company's general electronic products. It is guaranteed to perform according to delivery specifications. For any other use apart from general electronic equipment, we cannot take responsibility if the product is used in nuclear power control equipment, aerospace equipment , fire and security systems or any other applications in which there is a direct risk to human life and where extremely high levels of reliability are required.



LCM Model PE240128WRF-001-HQ  
 版次Ver.0

# LCM包裝規格書

## LCM Packaging Specifications

(For Tray)

Approve 研發 95.4.27 張慶源	Check 研發 95.4.13. 郭政玲	Contact 研發 95.4.11. 賴銘信
---------------------------------	--------------------------------	----------------------------------

### 1. 包裝材料規格表 (Packaging Material) : (per carton)

No.	Item	Model	Dimensions (mm)	Quantity
1	成品 (LCM)	PE240128WRF-001-HQ	99.2 X 62.8	96
2	多層薄膜(1)POF	OTFILM0BA03ABA	19"X350X0.015	6
3	TRAY 盤 (2)	TYPE24012801BA	352 X 260 X 24.8	18
4	內盒(3)Product Box	BX36627063ABBA	393 X 274 X 68	6
5	保力龍板(4)Pollyon board	OTPLB00PL08ABA	550 X 393 X 20	2
6	外紙箱(5)Carton	BX57041027CCBA	570 X 410 X 265	1
7				
8				
9				

### 2. 單箱數量規格表 (Packaging Specifications and Quantity) :

(1) LCM quantity per box : no per tray	8	x no per tray	2	=	16
(2) Total LCM quantity in carton : quantity per box	16	x no of boxes	6	=	96

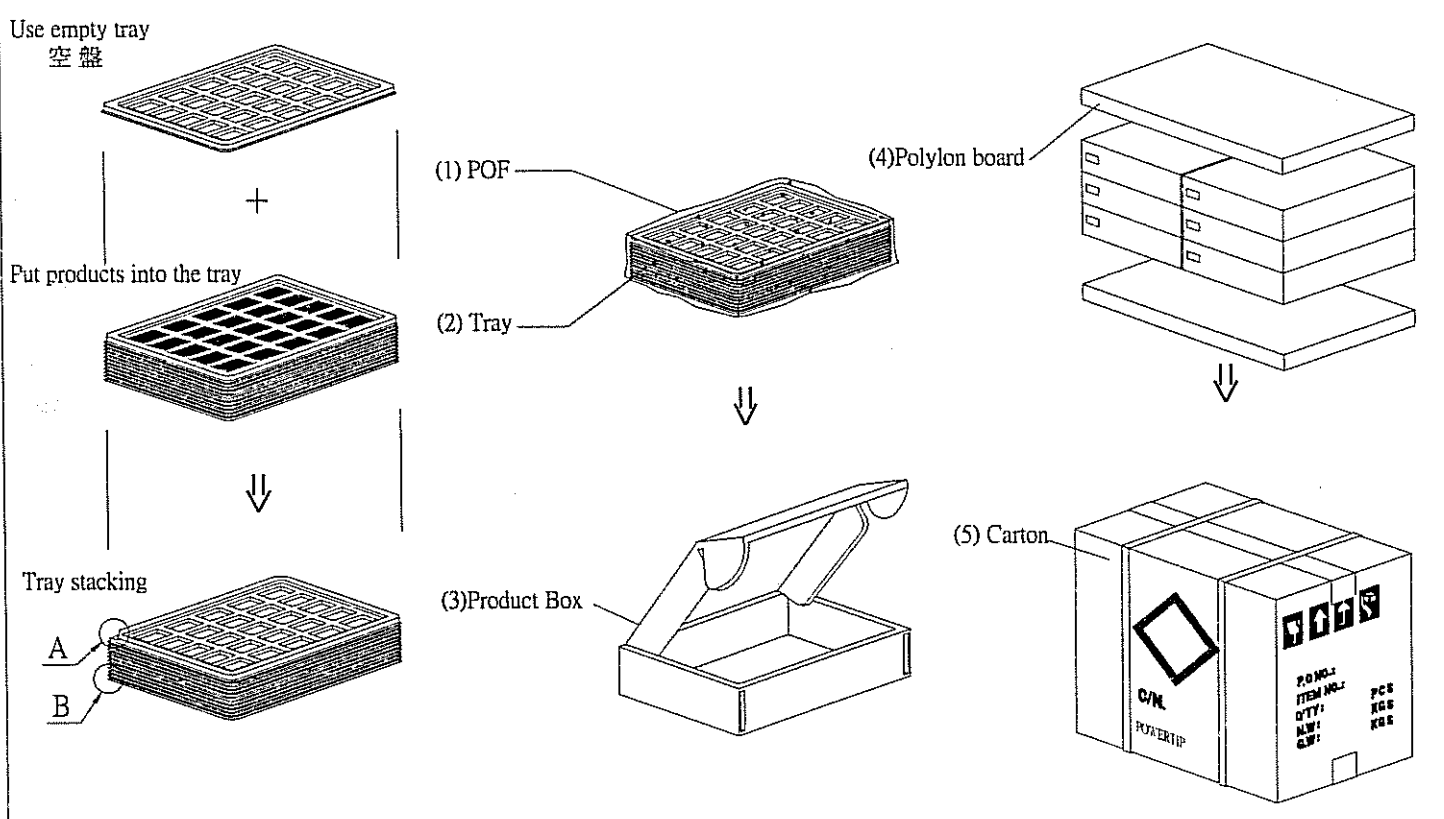

### 特 記 事 項 (REMARK)

#### 1. Label Specifications :

MODEL: \_\_\_\_\_  
 LOT NO: \_\_\_\_\_  
 QUANTITY: \_\_\_\_\_  
 CHECK: \_\_\_\_\_

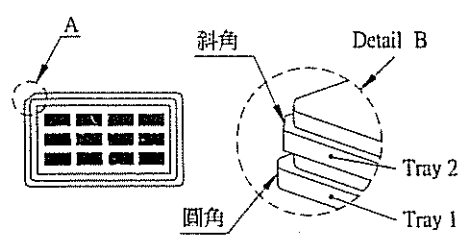

Rotate tray 180 degrees and place on top of stack.  
 Check the tray stack using Fig. B.  
 TRAY盤相疊時,需旋轉180度,請詳見B視圖

3. It's also suitable to Panel (可適用於單品包裝)  
 4. TRAY Number PE240128-001