

1N728WS

SILICON EPITAXIAL PLANAR SCHOTTKY BARRIER DIODE

For super-high speed switching and wave detection circuit applications

PINNING

PIN	DESCRIPTION
1	Cathode
2	Anode

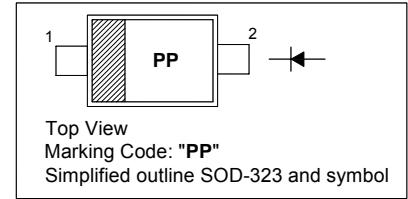

Absolute Maximum Ratings ($T_a = 25\text{ }^\circ\text{C}$)

Parameter	Symbol	Value	Unit
Peak Reverse Voltage	V_{RM}	30	V
Reverse Voltage	V_R	30	V
Forward Current	I_F	30	mA
Peak Forward Current	I_{FM}	150	mA
Junction Temperature	T_j	125	$^\circ\text{C}$
Storage Temperature Range	T_s	- 55 to + 125	$^\circ\text{C}$

Characteristics at $T_a = 25\text{ }^\circ\text{C}$

Parameter	Symbol	Typ.	Max.	Unit
Forward Voltage at $I_F = 1\text{ mA}$ at $I_F = 30\text{ mA}$	V_F	- -	0.4 1	V
Reverse Current at $V_R = 30\text{ V}$	I_R	-	0.3	μA
Terminal Capacitance at $V_R = 1\text{ V}$, $f = 1\text{ MHz}$	C_T	1.5	-	pF
Reverse Recovery Time at $I_F = I_R = 10\text{ mA}$, $I_{rr} = 1\text{ mA}$, $R_L = 100\ \Omega$	t_{rr}	1	-	ns
Detection Efficiency at $V_{in} = 3\text{ V}_{(peak)}$, $f = 30\text{ MHz}$, $R_L = 3.9\text{ K}\Omega$, $C_L = 10\text{ pF}$	η	65	-	%

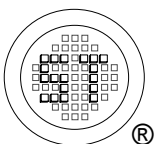

SEMTECH ELECTRONICS LTD.

(Subsidiary of Sino-Tech International Holdings Limited, a company listed on the Hong Kong Stock Exchange, Stock Code: 724)



ISO/TS 16949 : 2002
Certificate No. 05103



ISO 14001:2004
Certificate No. 71116



ISO 9001:2000
Certificate No. 0506098

Dated : 01/09/2006

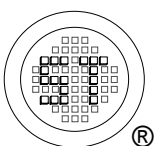
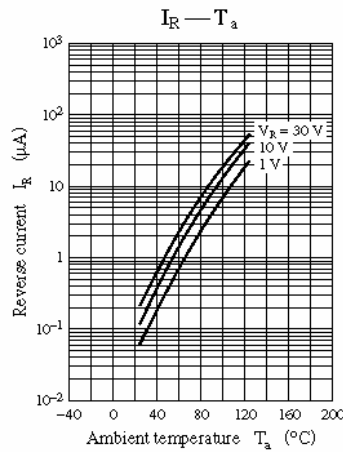
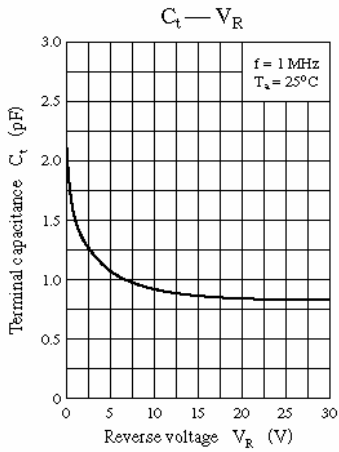
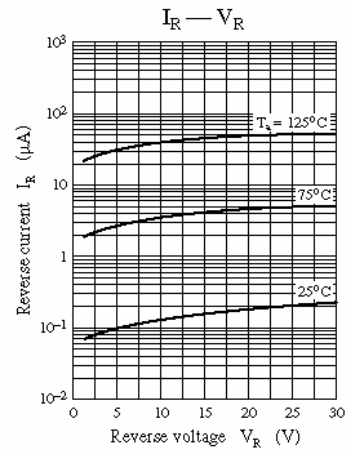
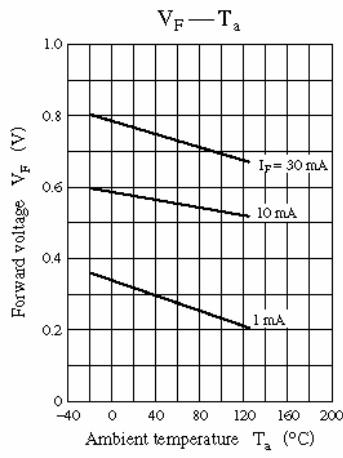
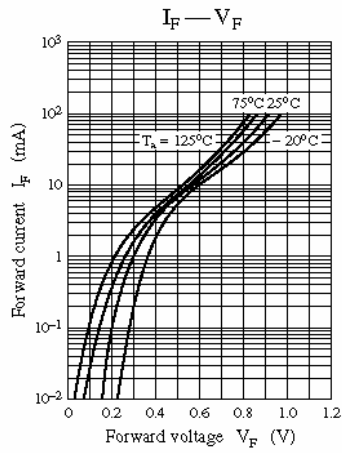

SEMTECH ELECTRONICS LTD.
 (Subsidiary of Sino-Tech International Holdings Limited, a company listed on the Hong Kong Stock Exchange, Stock Code: 724)



1N728WS

PACKAGE OUTLINE

Plastic surface mounted package; 2 leads

SOD-323

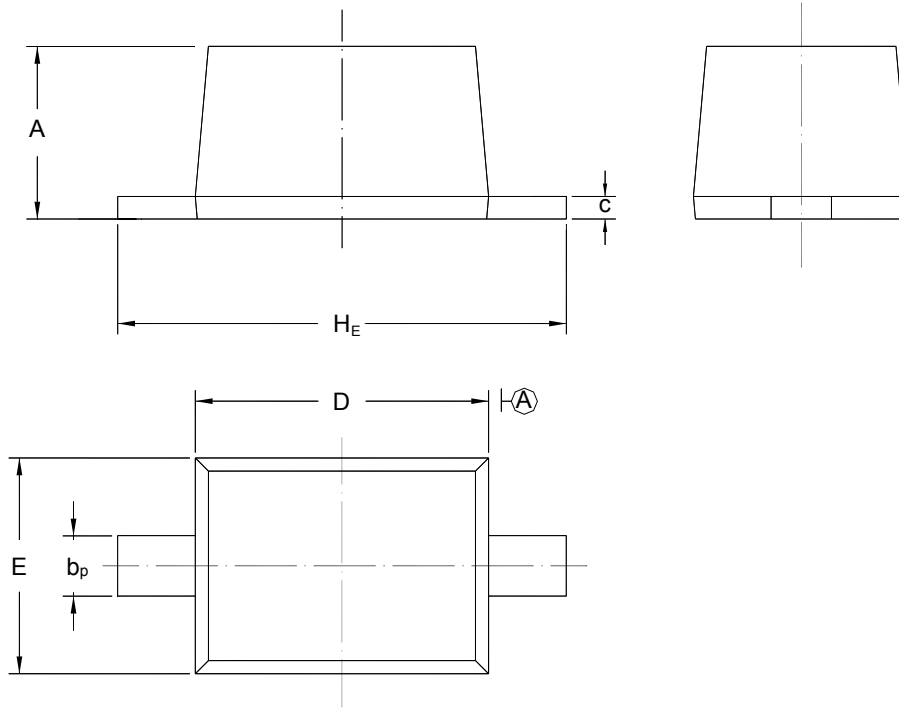

UNIT	A	b _p	C	D	E	H _E
mm	1.10 0.80	0.40 0.25	0.15 0.00	1.80 1.60	1.35 1.15	2.80 2.30

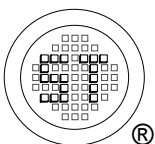

SEMTECH ELECTRONICS LTD.
 (Subsidiary of Sino-Tech International Holdings Limited, a company
 listed on the Hong Kong Stock Exchange, Stock Code: 724)



ISO/TS 16949 : 2002
 Certificate No. 05103



ISO 14001:2004
 Certificate No. 71116



ISO 9001:2000
 Certificate No. 0506098

Dated : 01/09/2006