



# PRODUCT SPECIFICATION

**Model No : CSPR-N30ASB4-A0R**

Descriptions:	
■ LED Type	: Superbright Lamp
■ LED Package	: Piranha LED Lamp
■ Emitting Color	: Blue
■ Viewing Angle	: 60°
■ Stopper	



CUSTOMER APPROVED SIGNATURES	APPROVED BY	CHECKED BY	PREPARED BY

**CHINA SEMICONDUCTOR CORPORATION**  
 Address:2FL. NO.909,Chung-Cheng Road,  
 Chung-Ho City Taipei Hsien,Taiwan.

Tel:886-2-2223-9696  
 Fax:886-2-2223-9377

**OPTO PLUS TECHNOLOGIES CO.,LTD**  
 Address:696 Shun jiang Rd.,Ji Shan St.Shaoxing,  
 ZheJiang,China

Tel:86-0575-88623888  
 Fax:86-0575-88623112



Spec. No.	PS-LU-N30ASB4-A0R
Rev.	A

**Model No : CSPR-N30ASB4-A0R**

**Features -**

1. High Current Operation
2. High Luminous Output
3. High Reliability and Solid Performance
4. Optimal Optical/Mechanical Design
5. Packaged in Tubes for Use with Automatic Pick and Place Equipment
6. Rohs Compliant

**Device Selection Guide -**

Part No.	Chip		LED Lens
	Material	Emitted Color	
CSPR-N30ASB4-A0R	InGaN	Blue	Water Transparent

**Package Outline Dimensions -**

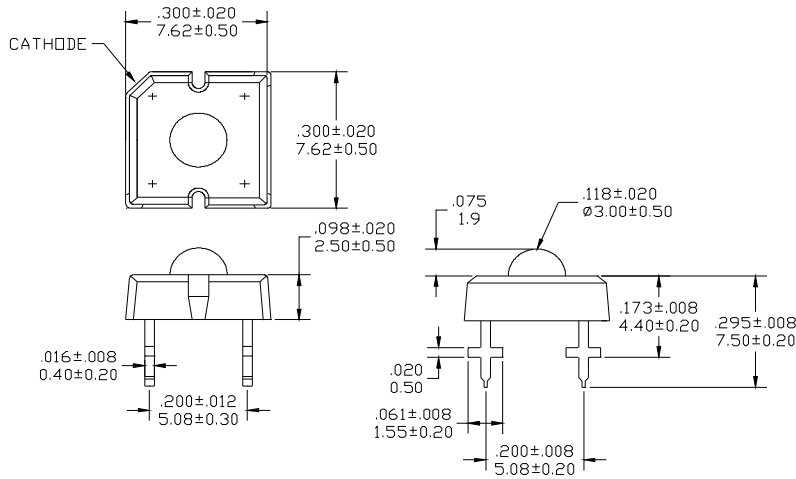

\* Tolerance :  $\pm \frac{0.01}{0.25}$  Unit :  $\pm \frac{\text{inch}}{\text{mm}}$



Model No : CSPR-N30ASB4-A0R

■ Absolute Maximum Rating -

(Ta=25°C)

Parameter	Symbol	Rating	Unit
Power Dissipation	Pd	190	mW
Forward Current (DC)	IF	50	mA
Peak Forward Current *	IFP	100	mA
Reverse Voltage	VR	5	V
Operating Temp.	Topr	-30 ~ +80	°C
Storage Temp.	Tstg	-40 ~ +100	°C
Lead Soldering Temperature	Tsol	Max. 260°C for 5 sec Max. (3mm from the epoxy bulb)	

\* Pulse width  $\leq 0.1$  msec. duty  $\leq 1/10$

■ Electro-optical Characteristics -

(Ta=25°C)

Parameter	Symbol	Min.	Typ.	Max.	Unit	Condition
Forward Voltage	VF	-----	3.3	3.8	V	IF=50mA
Luminous Intensity	Iv	1080	2000	-----	mcd	
Luminous Flux	Φv	600	1500	-----	mlm	
Dominant Wavelength	λd	-----	470	-----	nm	
Peak Wavelength	λp	-----	465	-----	nm	
Viewing Angle	2θ 1/2	-----	60	-----	deg	
Reverse Current	IR	-----	-----	100	μA	VR=5V



■ Luminous Flux Rank Limits (  $I_f = 50\text{mA}$  )

unit : mlm

Part No Code	CSPR-N30ASB4-A0R	
	min.	max.
A	600	1000
B	1000	1500
C	1500	2000
D	2000	2500

■ Dominant Wavelength Rank Limits (  $I_f = 50\text{mA}$  )

unit : nm

Part No Code	CSPR-N30ASB4-A0R	
	min.	max.
B5	460	465
B6	465	470
B7	470	475

■ Forward Voltage Rank Limits (  $I_f = 50\text{mA}$  )

unit : v

Part No Code	CSPR-N30ASB4-A0R	
	min.	max.
H	2.8	3.0
J	3.0	3.2
K	3.2	3.4
L	3.4	3.6
M	3.6	3.8

Notes:

1. Tolerance of measurement of luminous Flux :±15%
2. Tolerance of measurement of dominant wavelength :±2nm
3. Tolerance of measurement of forward voltage :±0.05v
4. All data are measured by CSC's test equipment.
5. One delivery will include several color rank, VF rank and  $I_v$  ranks of the products.
6. The quantity-ratio of the ranks is decided by CSC.
7. Please confirm with CSC salesman, if your request different from standard specification.



Model No : CSPR-N30ASB4-A0R

■ Typical Electrical / Optical Characteristics Curves -

(Ta = 25°C Unless Otherwise Noted)

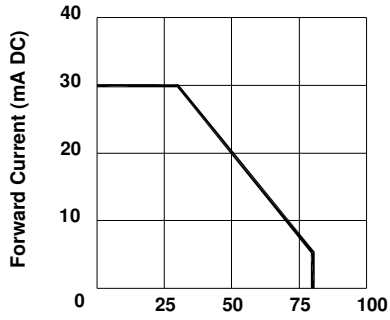

Ambient Temperature Ta (°C)  
Fig 1. Forward Current  
Vs. Ambient Temperature

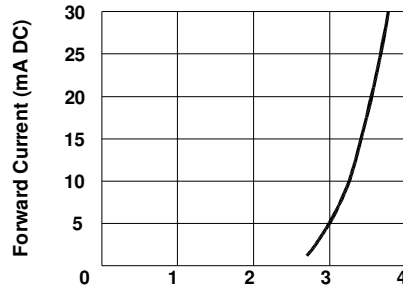

Forward Voltage VF (V)  
Fig 2. Forward Current  
Vs. Forward Voltage



Forward Current IF (mA DC)  
Fig 3. Relative Intensity  
Vs. Forward Current

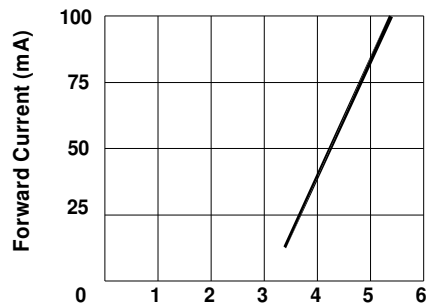

Forward Voltage (V)  
Fig 4. Peak Forward Voltage  
Vs. Forward Current  
(100us test pulse, 1% duty cycle)

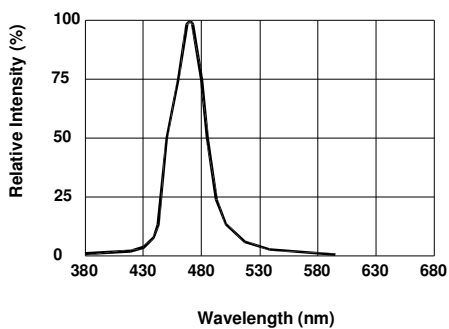

Fig 5. Relative Intensity Vs. Wavelength

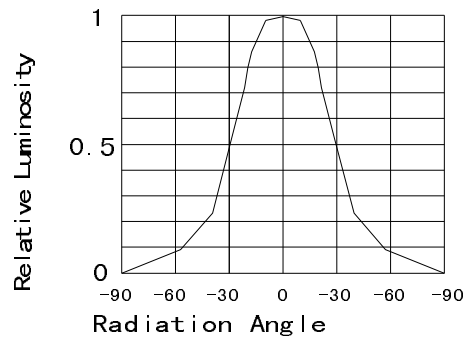

Fig 6. Relative Luminous Intensity vs. Radiation Angle



Model No : CSPR-N30ASB4-A0R

## ■ Precautions For Use -

### 1. Recommended Soldering conditions

#### Wave Soldering

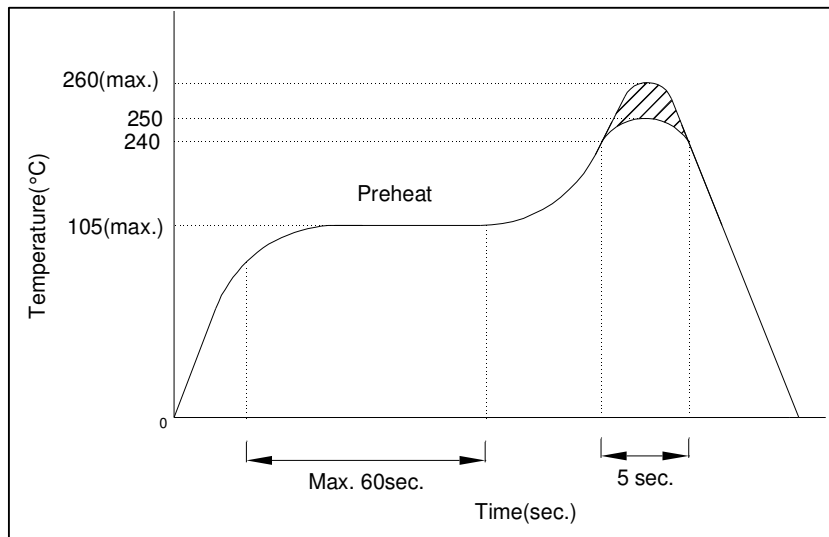

### 2. Soldering Iron

Basic SPEC. is  $\leq 5\text{sec.}$  When  $260^{\circ}\text{C}$ . If temperature is higher, time should be shorter ( $+10^{\circ}\text{C} \rightarrow -1\text{sec.}$ ). Power dissipation of iron should be smaller than 15W, and temperature should be controllable. Surface temperature of the device should be under  $230^{\circ}\text{C}$ .

### 3. Static Electricity

a. Static electricity or surge voltage damages LEDs..

It is recommended that a wrist band or an anti-electrostatic glove be used when handling the LEDs.

b. All devices, equipment and machinery must be properly grounded. It is recommended that measures be taken against surge voltage to the equipment that mounts the LEDs.

Note: The specifications are subject to change without notice. Please contact us for updated information.