

# SKT 1400



**Capsule Thyristor**

## Line Thyristor

### SKT 1400

#### Features

- Hermetic metal case with ceramic insulator
- Capsule package for double sided cooling
- Shallow design with single sided cooling
- Off-state and reverse voltages up to 3600 V
- Amplifying gate

#### Typical Applications

- DC motor control (e. g. for machine tools)
- Controlled rectifiers (e. g. for battery charging)
- AC controllers (e. g. for temperature control)
- Soft starters for AC motors
- Recommended snubber network e. g. for  $V_{VRMS} \leq 400$  V:  
 $R = 33 \Omega / 32$  W,  $C = 1 \mu F$

$V_{RSM}$ V	$V_{RRM}, V_{DRM}$ V	$I_{TRMS} = 3000$ A (maximum value for continuous operation) $I_{TAV} = 1400$ A (sin. 180; DSC; $T_c = 66$ °C)	
2700	2600	SKT 1400/26E	
2900	2800	SKT 1400/28E	
3300	3200	SKT 1400/32E	
3700	3600	SKT 1400/36E	

Symbol	Conditions	Values	Units
$I_{TAV}$	sin. 180; $T_c = 100$ (85) °C;	786 (1090)	A
$I_D$	2 x N4/250; $T_a = 45$ °C; B2 / B6	1700 / 2400	A
	2 x N4/400; $T_a = 45$ °C; B2 / B6	1900 / 2600	A
$I_{RMS}$	2 x N4/250; $T_a = 45$ °C; W1C	1900	A
$I_{TSM}$	$T_{vj} = 25$ °C; 10 ms	29000	A
	$T_{vj} = 125$ °C; 10 ms	25000	A
$i^2t$	$T_{vj} = 25$ °C; 8,3 ... 10 ms	4200000	A <sup>2</sup> s
	$T_{vj} = 125$ °C; 8,3 ... 10 ms	3125000	A <sup>2</sup> s
$V_T$	$T_{vj} = 25$ °C; $I_T = 3000$ A	max. 2,1	V
$V_{T(TO)}$	$T_{vj} = 125$ °C	max. 1,04	V
$r_T$	$T_{vj} = 125$ °C	max. 0,35	mΩ
$I_{DD}, I_{RD}$	$T_{vj} = 125$ °C; $V_{RD} = V_{RRM}, V_{DD} = V_{DRM}$	max. 100	mA
$t_{gd}$	$T_{vj} = 25$ °C; $I_G = 1$ A; $di_G/dt = 1$ A/μs	1	μs
$t_{gr}$	$V_D = 0,67 * V_{DRM}$	2	μs
$(di/dt)_{cr}$	$T_{vj} = 125$ °C	max. 150	A/μs
$(dv/dt)_{cr}$	$T_{vj} = 125$ °C	max. 1000	V/μs
$t_q$	$T_{vj} = 125$ °C	200 ... 300	μs
$I_H$	$T_{vj} = 25$ °C; typ. / max.	500 / 1000	mA
$I_L$	$T_{vj} = 25$ °C; typ. / max.	2000 / 5000	mA
$V_{GT}$	$T_{vj} = 25$ °C; d.c.	min. 3	V
$I_{GT}$	$T_{vj} = 25$ °C; d.c.	min. 300	mA
$V_{GD}$	$T_{vj} = 125$ °C; d.c.	max. 0,25	V
$I_{GD}$	$T_{vj} = 125$ °C; d.c.	max. 10	mA
$R_{th(j-c)}$	cont.; DSC	0,018	K/W
$R_{th(j-c)}$	sin. 180; DSC / SSC	0,0185 / 0,039	K/W
$R_{th(j-c)}$	rec. 120; DSC / SSC	0,02 / 0,041	K/W
$R_{th(c-s)}$	DSC / SSC	0,003 / 0,006	K/W
$T_{vj}$		- 40 ... + 125	°C
$T_{stg}$		- 40 ... + 130	°C
$V_{isol}$		-	V~
F	mounting force	27 ... 34	kN
a			m/s <sup>2</sup>
m	approx.	1000	g
Case		B 19	



**SKT**

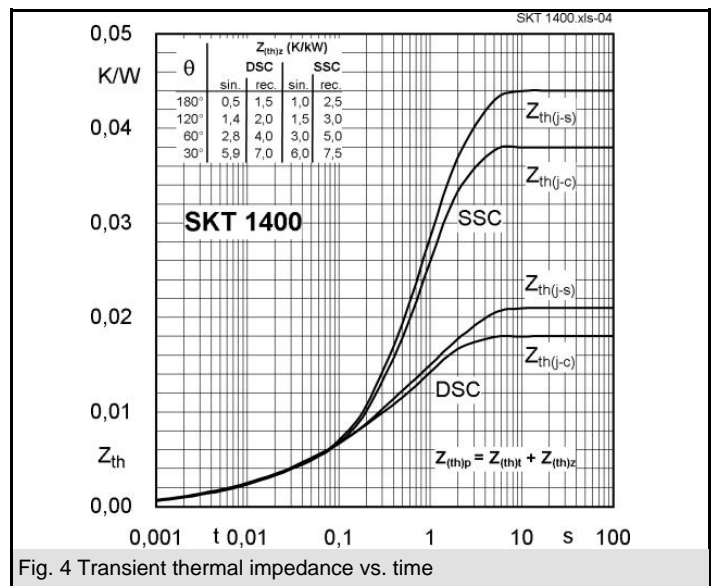
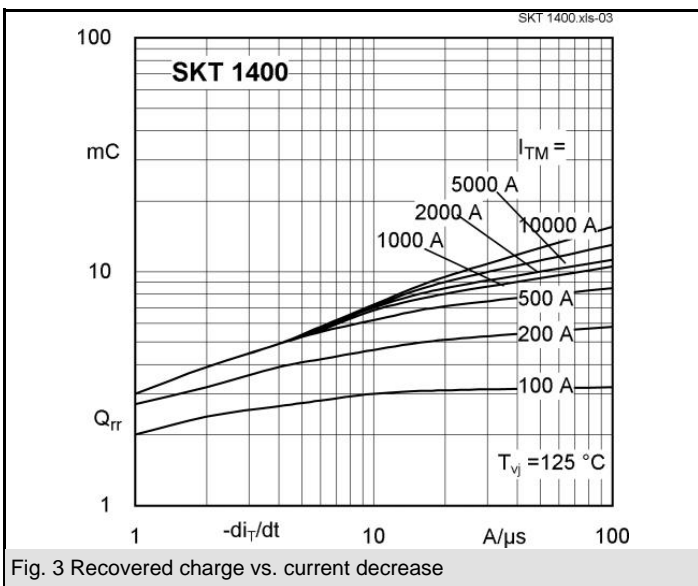
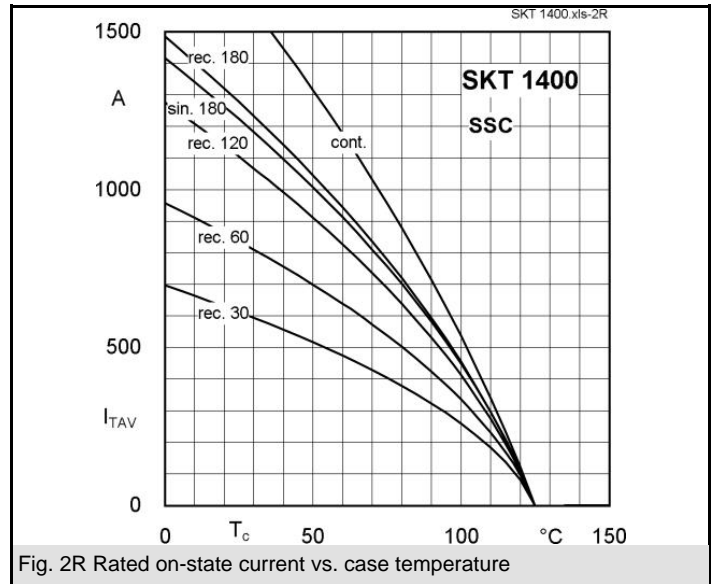
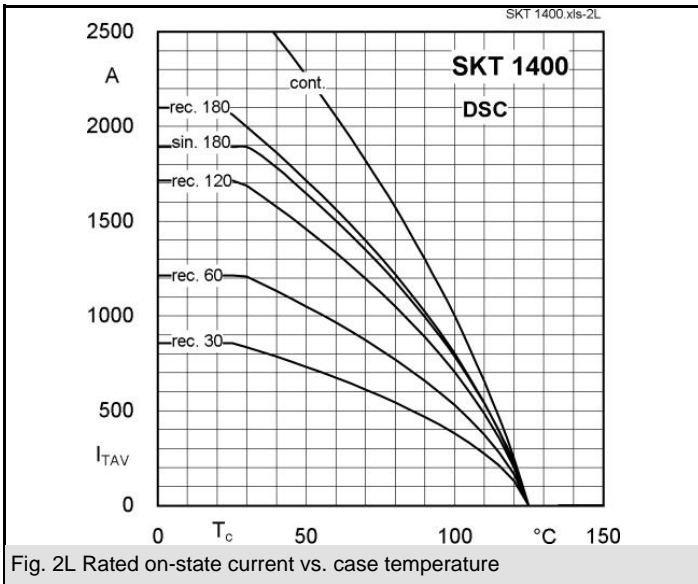
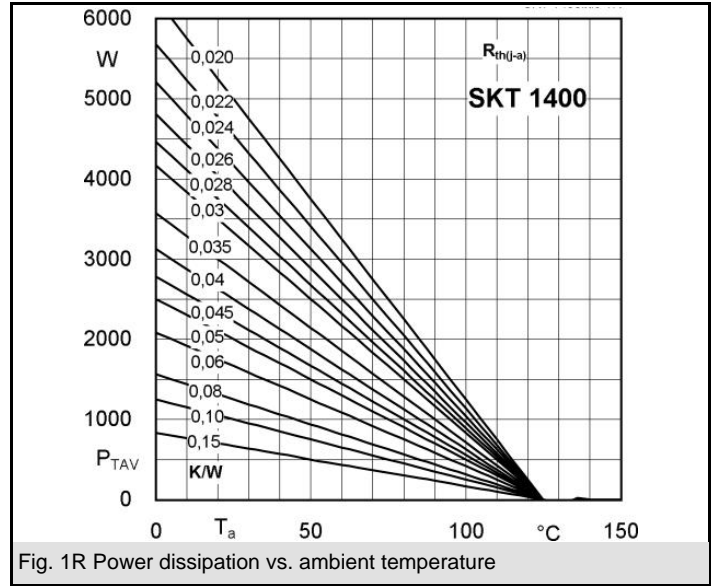
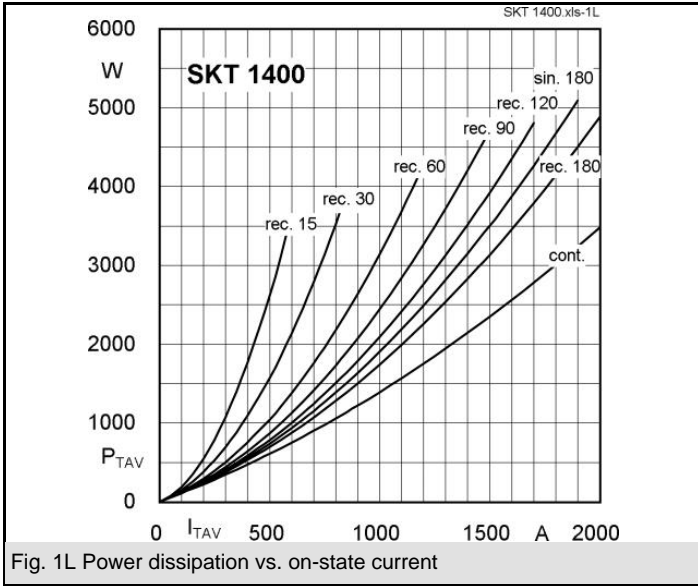

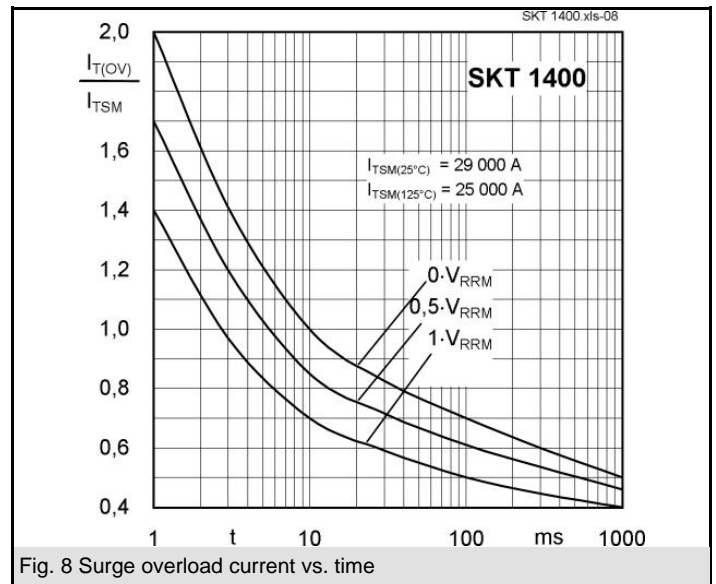
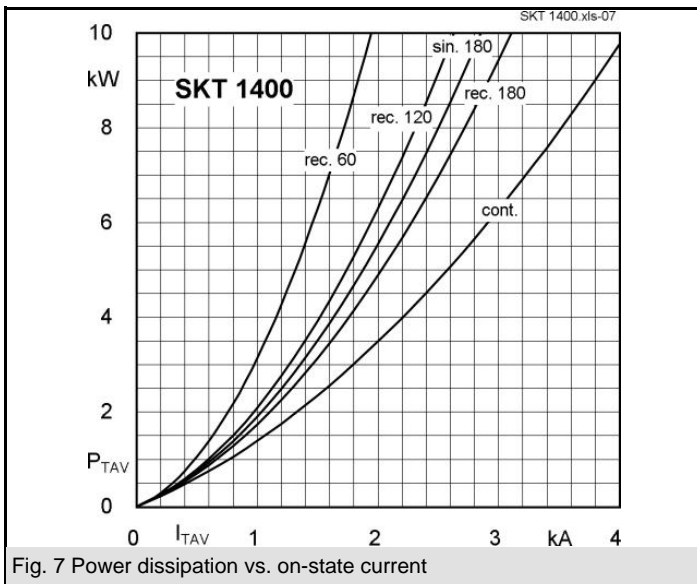
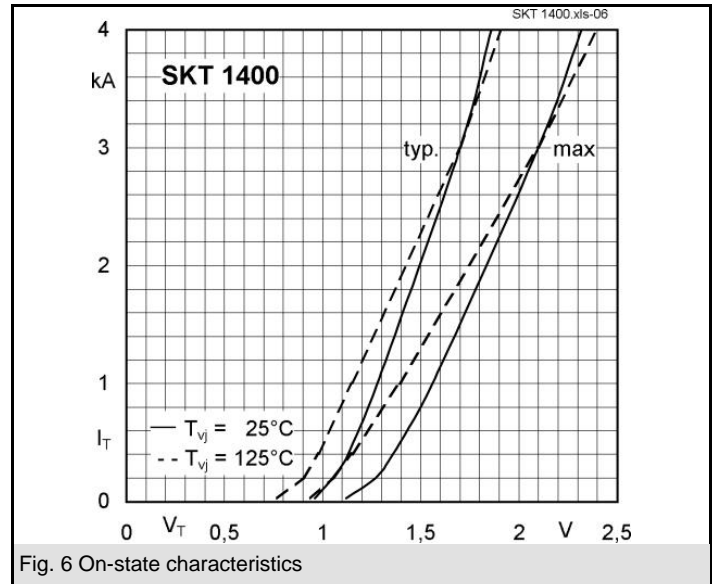
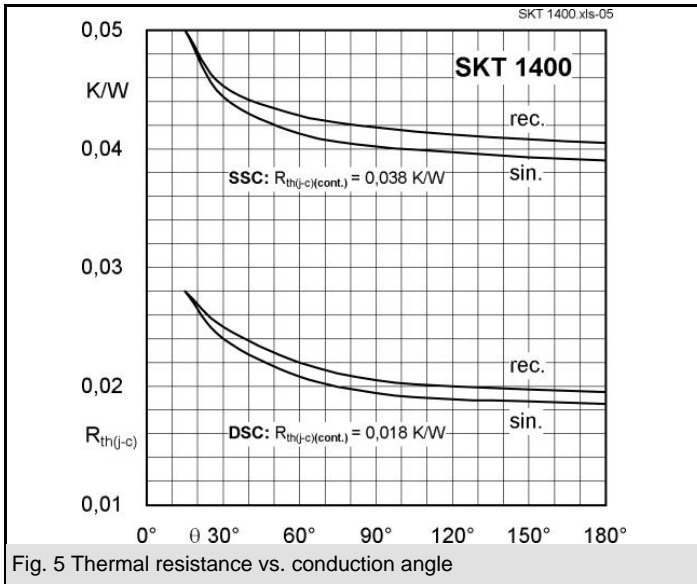

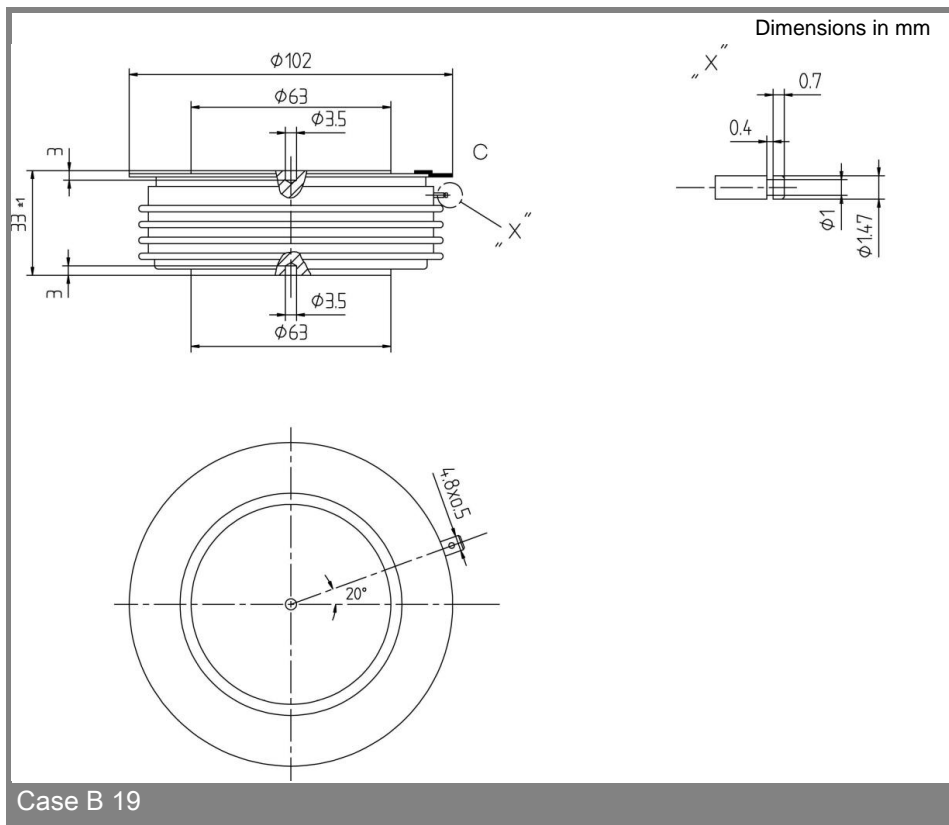
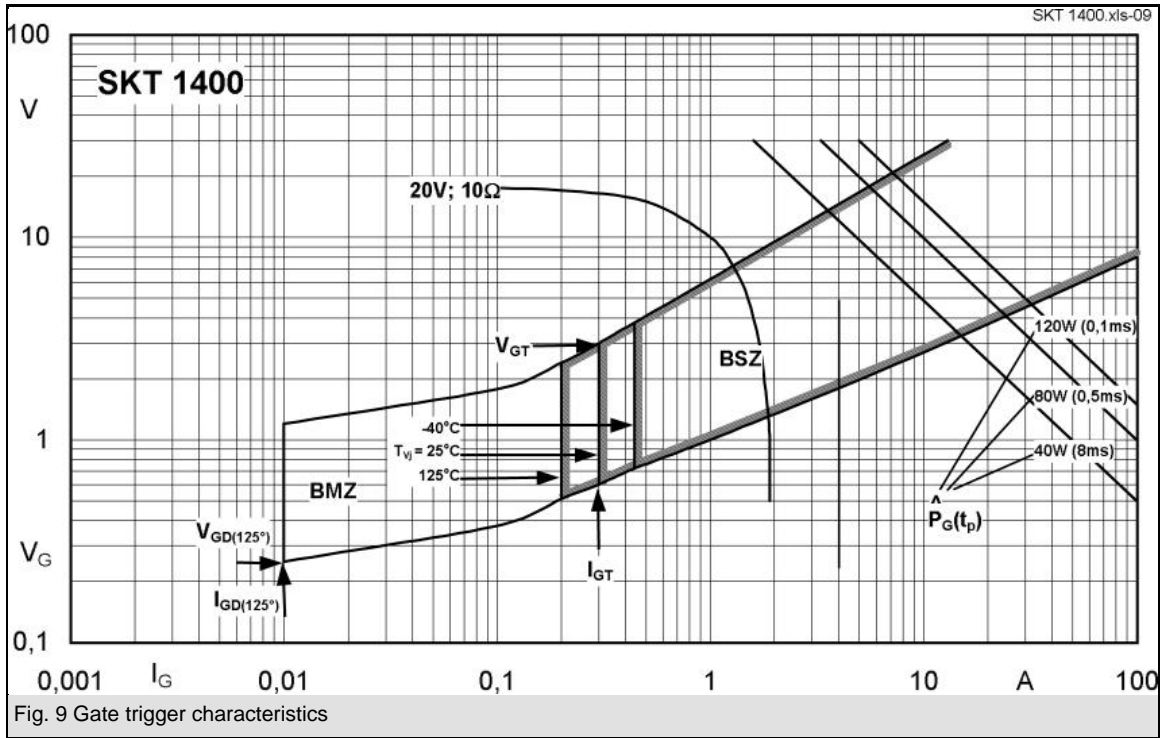

This technical information specifies semiconductor devices but promises no characteristics. No warranty or guarantee expressed or implied is made regarding delivery, performance or suitability.