

HA1631S01/02/03/04 Series

Single CMOS Comparator (Push Pull/Open Drain Output)

REJ03D0056-0200

Rev.2.00

Mar 10, 2006

Description

The HA1631S01/02/03/04 are low power single CMOS Comparator featuring low voltage operation with typical current supply of 5 μ A/50 μ A. They are designed to operate from a single power supply. HA1631S01/02 have push-pull full swing outputs that allow direct connections to logic devices. The Open Drain version HA1631S03/04 enable Output Level shifting through external pull up resistors. Available in an ultra-small CMPAK-5 package, they occupy only 1/8 the area of the SOP-8 package.

Features

- Low supply current
 HA1631S01/03 : $I_{DDtyp} = 5 \mu A$ ($V_{DD} = 3.0 V$)
 HA1631S02/04 : $I_{DDtyp} = 50 \mu A$ ($V_{DD} = 3.0 V$)
- Low voltage operation : $V_{DD} = 1.8$ to $5.5 V$
- Low input offset voltage : $V_{IOmax} = 5 mV$
- Low input bias current : $I_{IBtyp} = 1 pA$
- Maximum output voltage : $V_{OHmin} = 2.9 V$ (at $V_{DD} = 3.0 V$)
- Input common voltage range includes ground
- On-chip ESD protection
- Available in CMPAK-5 and MPAK-5 package using Pb free lead frame

Ordering Information

Type No.	Package Name	Package Code
HA1631S01CM	CMPAK-5	PTSP0005ZC-A
HA1631S02CM		
HA1631S03CM		
HA1631S04CM		
HA1631S01LP	MPAK-5	PLSP0005ZB-A
HA1631S02LP		
HA1631S03LP		
HA1631S04LP		

Pin Arrangement

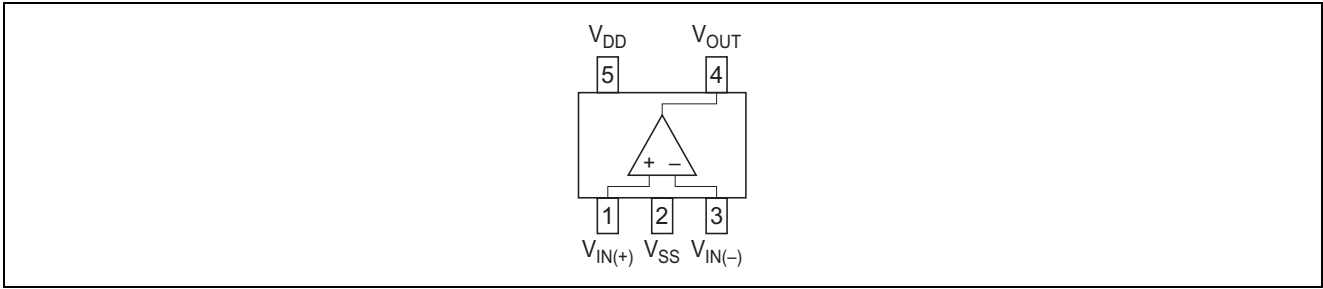

Equivalent Circuit

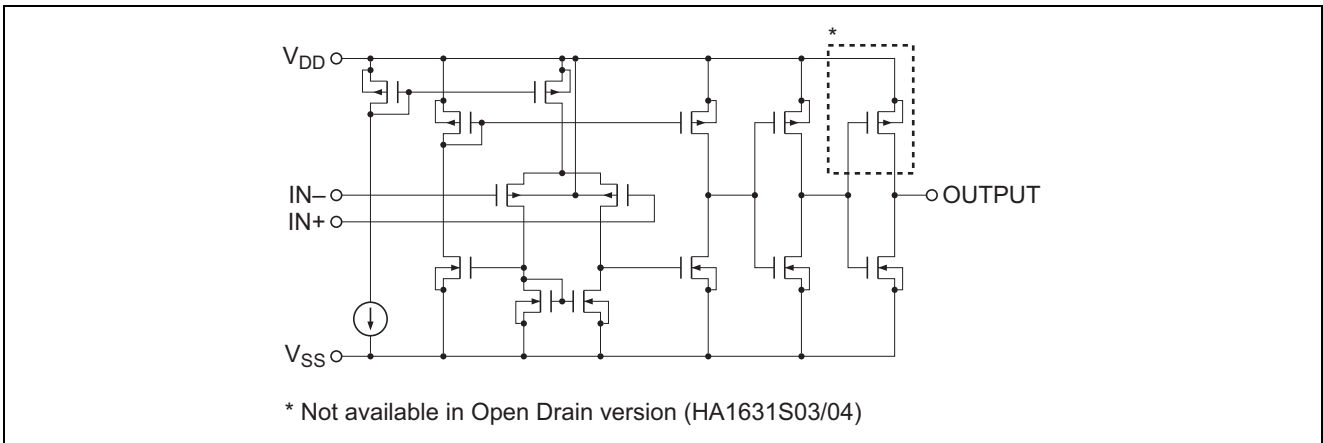

Absolute Maximum Ratings

(Ta = 25°C)

Item	Symbol	Ratings	Unit	Remarks
Supply voltage	V _{DD}	7.0	V	
Differential input voltage	V _{IN(diff)}	-V _{DD} to +V _{DD}	V	Note 1
Input voltage	V _{IN}	0.1 to +V _{DD}	V	
Output current	I _{OUT}	28	mA	Note 2
Power dissipation	P _T	80/120	mW	CMPAK-5/MPAK-5
Operating temperature	T _{opr}	-40 to +85	°C	
Storage temperature	T _{stg}	-55 to +125	°C	

Notes: 1. Do not apply input voltage exceeding V_{DD} or 7 V.

2. The maximum output current is the maximum allowable value for continuous operation.

Electrical Characteristics

(Ta = 25°C, V_{DD} = 3.0 V, V_{SS} = 0 V)

Item	Symbol	Min	Typ	Max	Unit	Test Conditions	
Input offset voltage	V _{IO}	—	—	5	mV	V _{IN} = V _{DD} /2, R _L = 1MΩ	
Input bias current	I _{IB}	—	(1)	100	pA	V _{IN} = V _{DD} /2	
Input offset current	I _{IO}	—	(1)	100	pA	V _{IN} = V _{DD} /2	
Common mode input voltage range	V _{CM}	-0.1	—	2.1	V		
Supply current	HA1631S01/03	I _{DD}	—	5	10	μA	V _{DD} = 3V, V _{IN+} = 1V, V _{IN-} = 0V
	HA1631S02/04		—	50	100	μA	
Response time	HA1631S01	TP _{LH}	—	(1.20)	—	μs	1V DC bias, 100mV overdrive, C _L = 15pF
	HA1631S01/03	TP _{HL}	—	(0.55)	—	μs	
	HA1631S01	t _r	—	(24)	—	ns	
	HA1631S01/03	t _f	—	(7)	—	ns	
	HA1631S02	TP _{LH}	—	(0.33)	—	μs	
	HA1631S02/04	TP _{HL}	—	(0.17)	—	μs	
	HA1631S02	t _r	—	(12)	—	ns	
HA1631S02/04	t _f	—	(7)	—	ns		
Output source current (HA1631S01/02)	I _{OSOURCE}	6	13	—	mA	V _{out} = 2.5V	
Output sink current	I _{OSINK}	7	14	—	mA	V _{out} = 0.5V	
Common mode rejection ratio	HA1631S01/03	CMRR	60	80	—	dB	V _{IN1} = 0V, V _{IN2} = 2V
	HA1631S02/04		50	70	—	dB	
Power supply rejection ratio	PSRR	60	80	—	dB	V _{DD1} = 1.8V, V _{DD2} = 5.5V	
Output voltage high	V _{OH}	V _{DD} -0.1	—	—	V	R _L = 10kΩ to V _{SS}	
Output voltage low	V _{OL}	—	—	0.1	V	R _L = 10kΩ to V _{DD}	
Output leakage current (Only for HA1631S03/04)	I _{LO}	—	(0.1)	—	nA	V _{IN+} = 1V, V _{IN-} = 0V, V _O = 3V	
Operating voltage range	V _{opr}	1.8	—	5.5	V		

Note: () : Design specification

Table of Graphs

Electrical Characteristics			HA1631S01 Figure	HA1631S02 Figure	HA1631S03 Figure	HA1631S04 Figure	Test Circuit No.
Supply current	I_{DD}	vs. Supply voltage(Out H)	1-1	2-1	3-1	4-1	1
		vs. Supply voltage(Out L)	1-2	2-2	3-2	4-2	2
		vs. Temperature(Out H)	1-3	2-3	3-3	4-3	1
Output high voltage	V_{OH}	vs. Rload	1-18	2-18	3-4	4-4	4
Output source current	$I_{OSOURCE}$	vs. Output high voltage	1-4	2-4	—	—	5
Output low voltage	V_{OL}	vs. Rload	1-17	2-17	3-14	4-14	6
Output sink current	I_{OSINK}	vs. Output low voltage	1-5	2-5	3-4	4-4	5
Input offset voltage	V_{IO}	vs. Supply voltage	1-6	2-6	3-5	4-5	8
		vs. Temperature	1-7	2-7	3-6	4-6	7
Common mode input voltage range	V_{CM}	vs. Temperature	1-8	2-8	3-7	4-7	9
Power supply rejection ratio	PSRR	vs. Supply voltage	1-9	2-9	3-8	4-8	11
Common mode rejection ratio	CMRR	vs. Input voltage	1-10	2-10	3-9	4-9	12
Input bias current	I_{IB}	vs. Temperature	1-11	2-11	3-10	4-10	10
		vs. Input voltage	1-12	2-12	3-11	4-11	10
Falling time	t_f	vs. Temperature	1-13	2-13	3-12	4-12	13
		vs. Cload	1-15	2-15	3-13	4-13	13
		Time waveform	1-20	2-20	3-15	4-15	13
Rising time	t_r	vs. Temperature	1-14	2-14	—	—	13
		vs. Cload	1-16	2-16	—	—	13
		Time waveform	1-19	2-19	—	—	13
Propagation delay time	TP_{LH}	Time waveform	1-21	2-21	—	—	13
	TP_{HL}	Time waveform	1-22	2-22	3-16, 3-17	4-16, 4-17	13

Main Characteristics

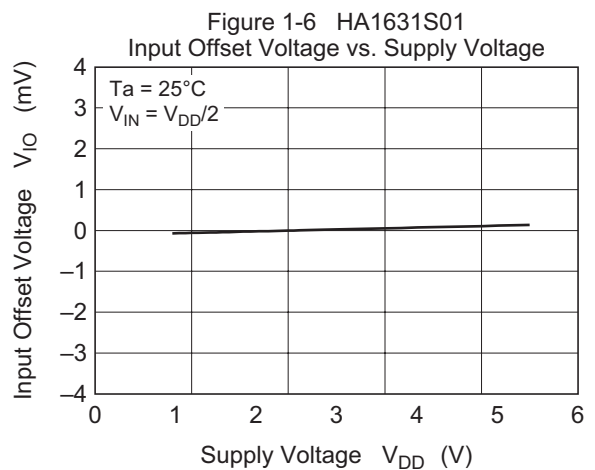
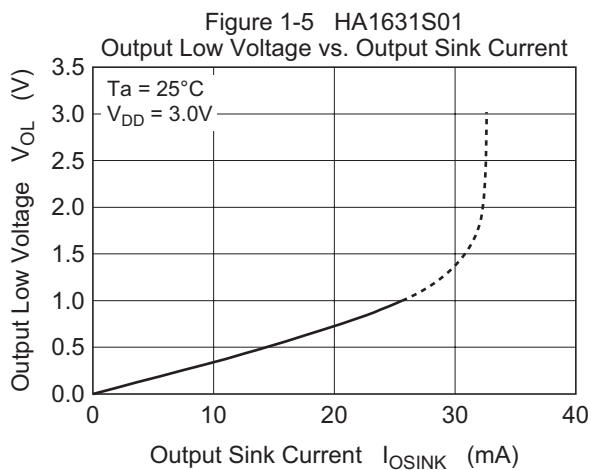
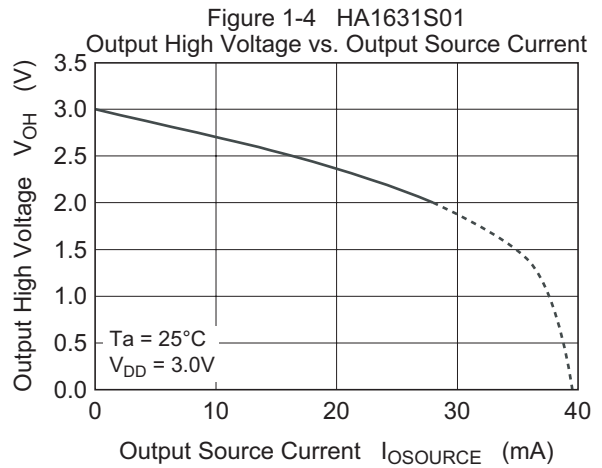
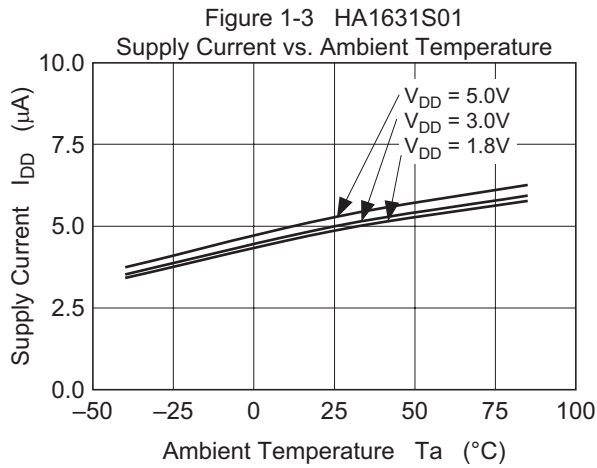
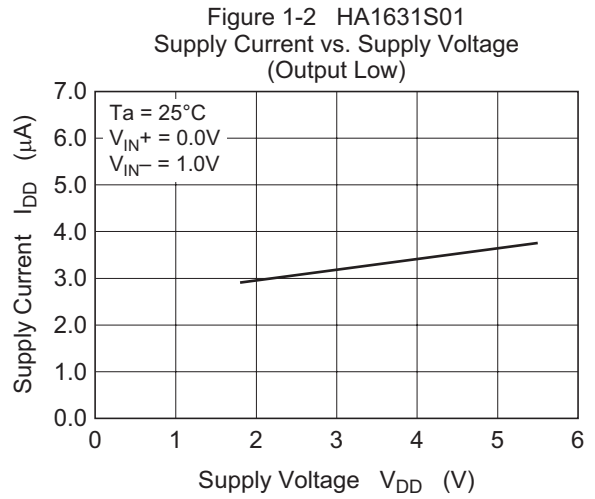
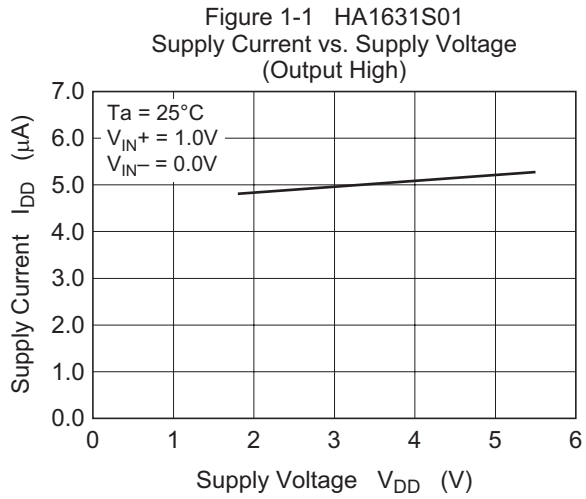

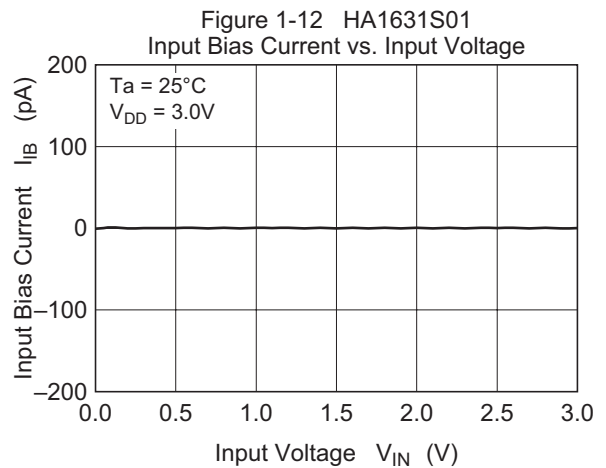
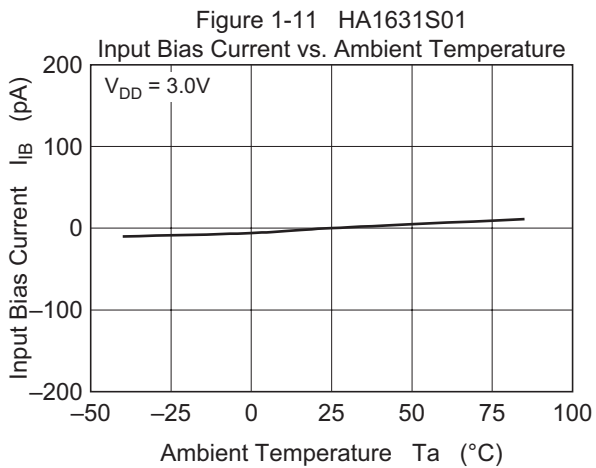
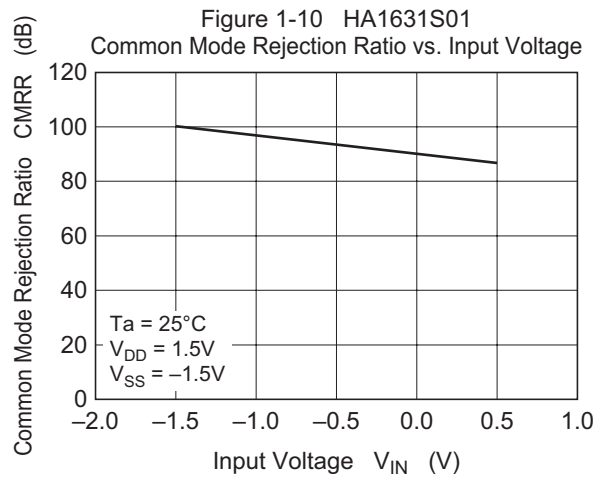
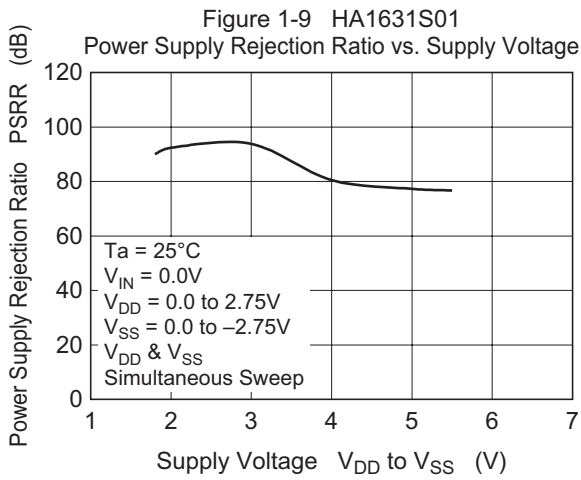
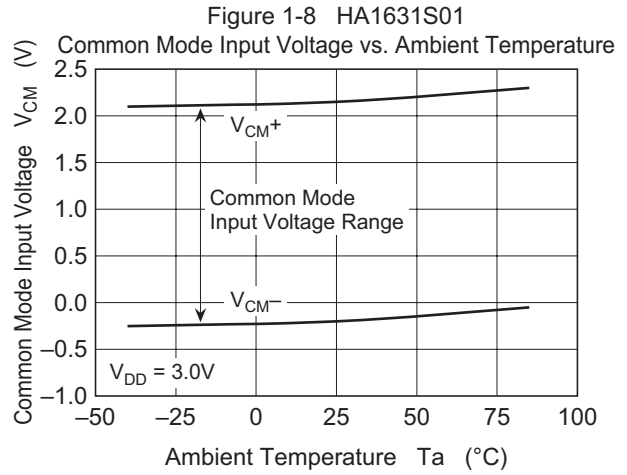
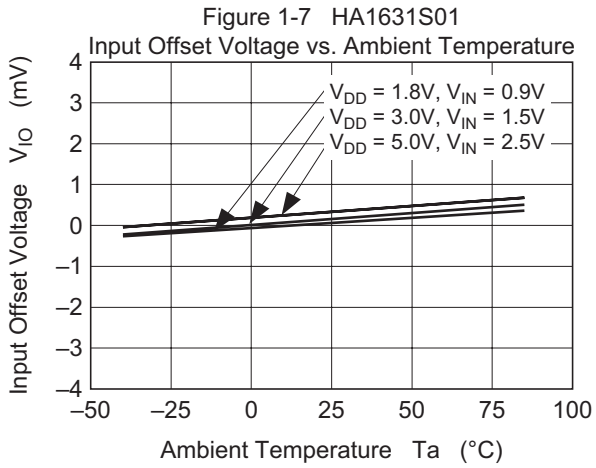

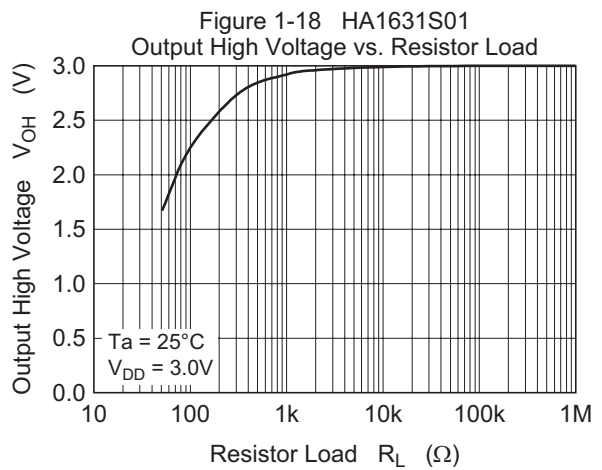
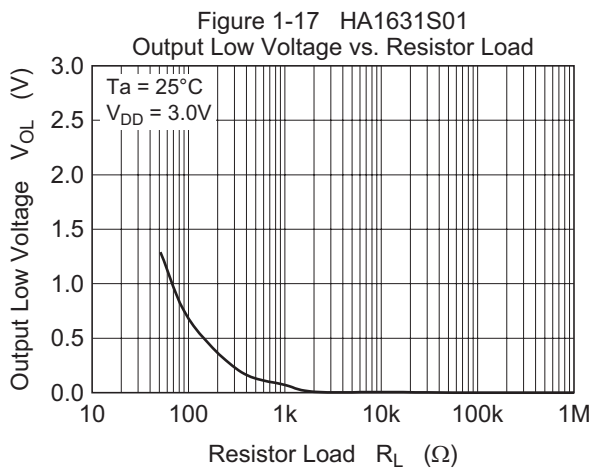
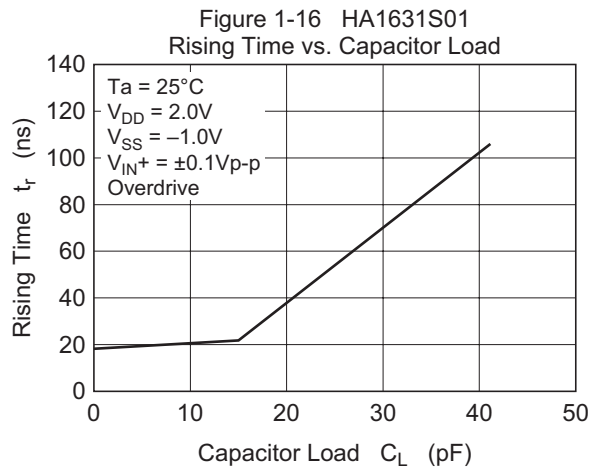
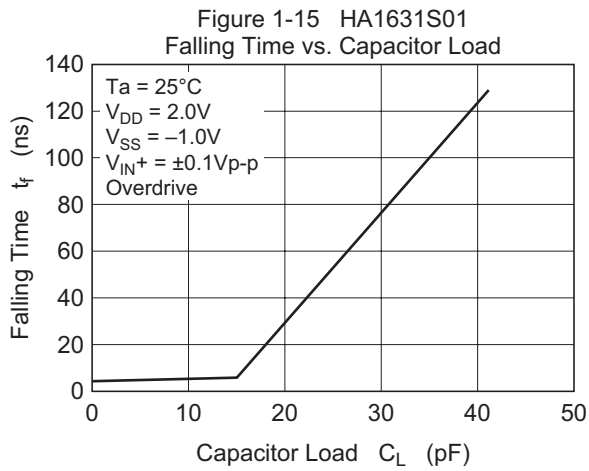
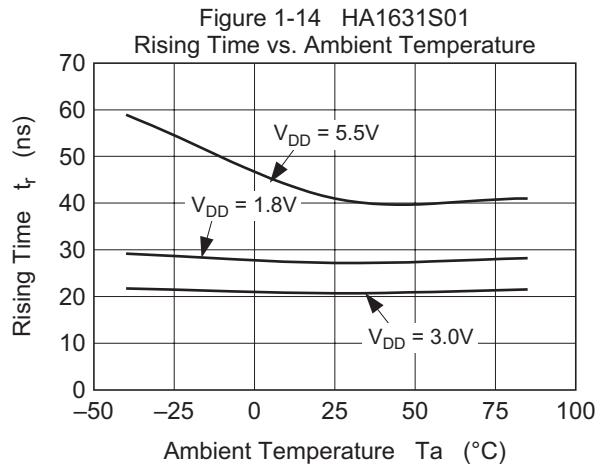
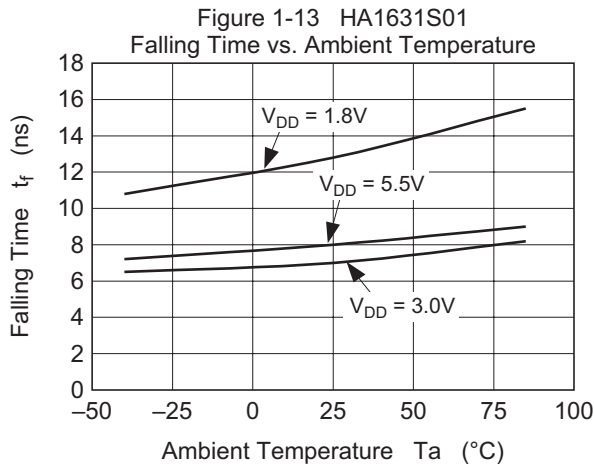

Figure 1-19 HA1631S01
Rising Time, t_r
(Overdrive = $\pm 0.1V_{p-p}$)

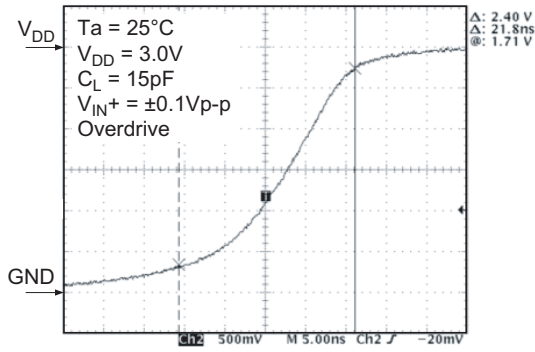

Figure 1-20 HA1631S01
Falling Time, t_f
(Overdrive = $\pm 0.1V_{p-p}$)

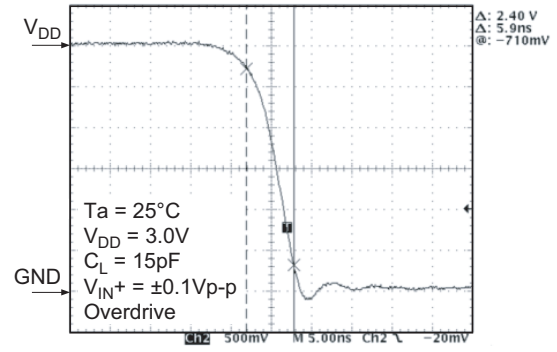

Figure 1-21 HA1631S01
 TP_{LH} Transient Response
(Overdrive = $\pm 0.1V_{p-p}$)

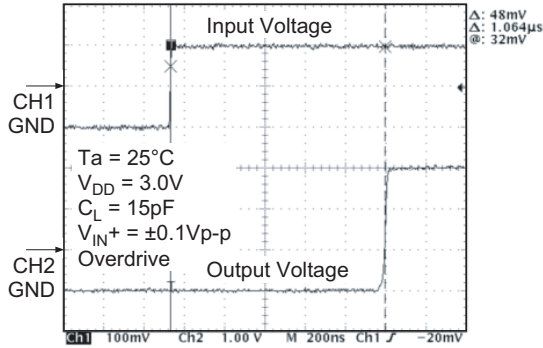

Figure 1-22 HA1631S01
 TP_{HL} Transient Response
(Overdrive = $\pm 0.1V_{p-p}$)

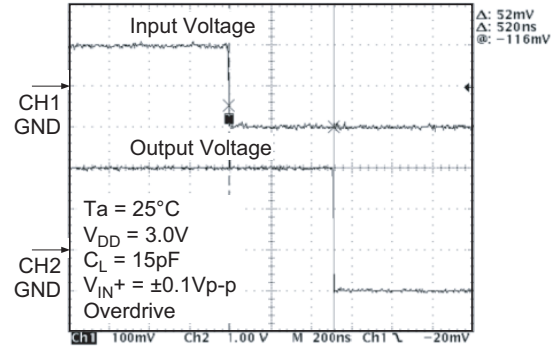

Figure 2-1 HA1631S02
Supply Current vs. Supply Voltage
(Output High)

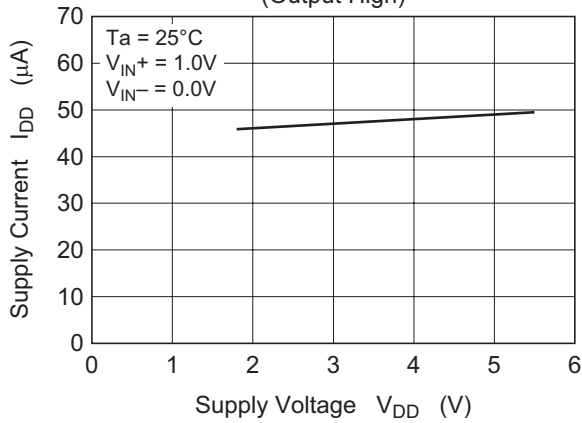

Figure 2-2 HA1631S02
Supply Current vs. Supply Voltage
(Output Low)

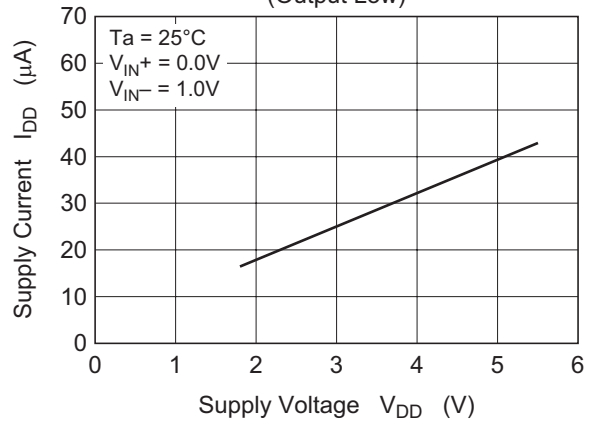

Figure 2-3 HA1631S02
Supply Current vs. Ambient Temperature

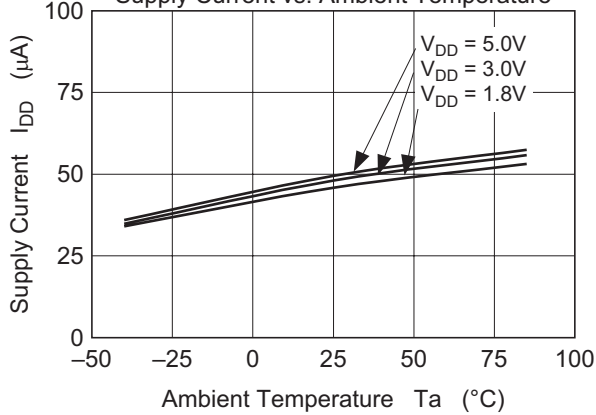

Figure 2-4 HA1631S02
Output High Voltage vs. Output Source Current

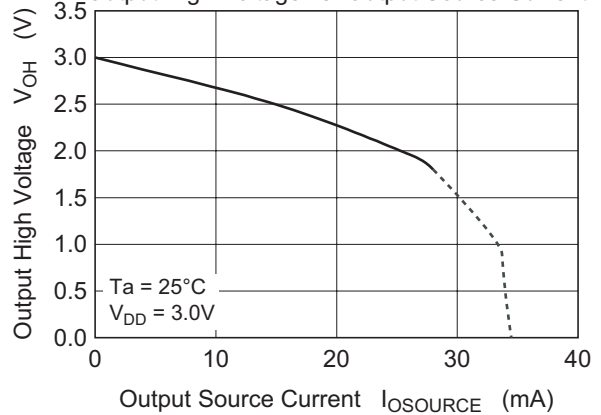

Figure 2-5 HA1631S02
Output Low Voltage vs. Output Sink Current

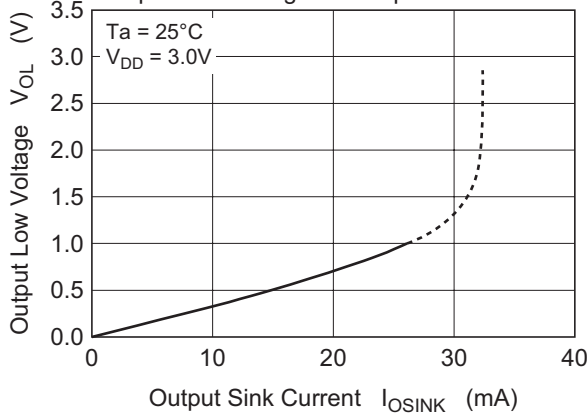
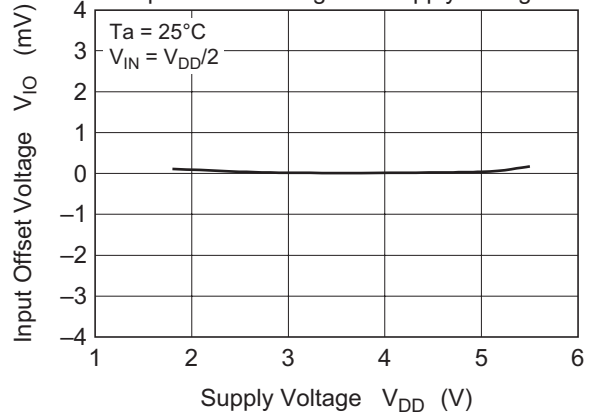
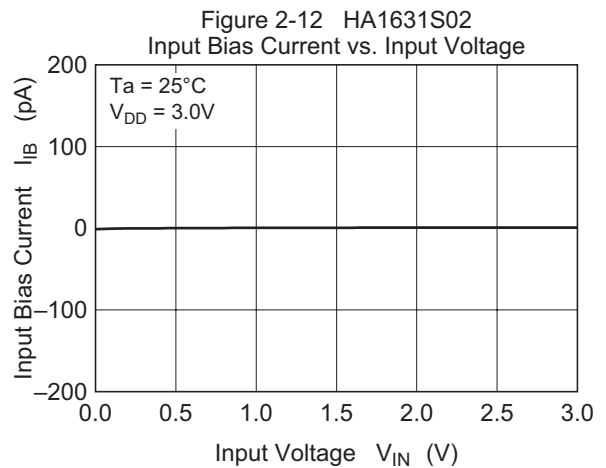
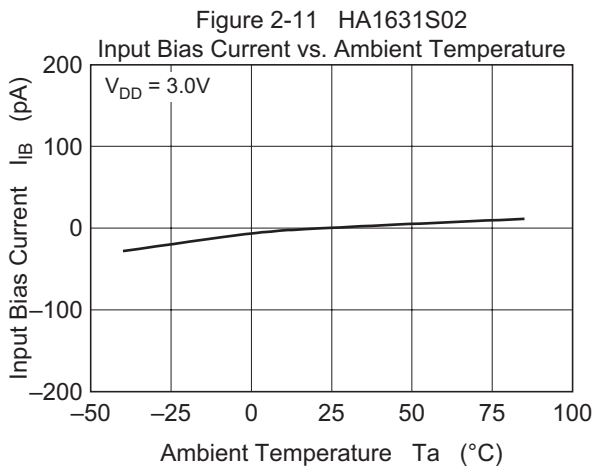
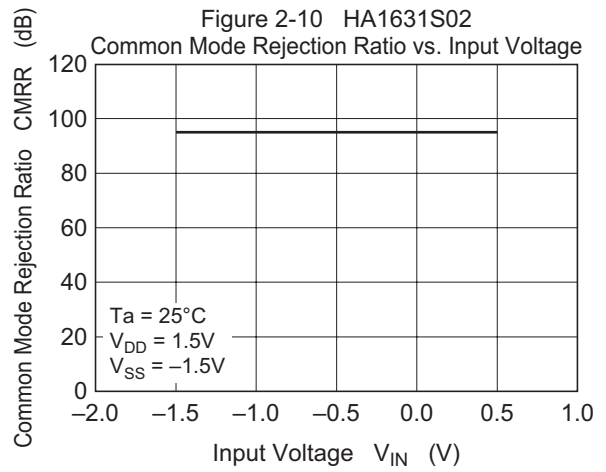
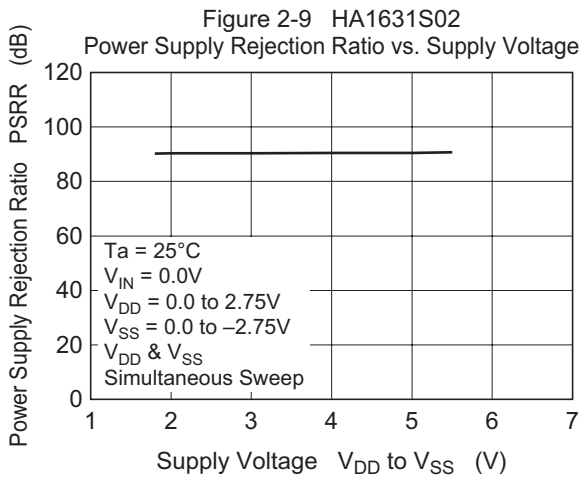
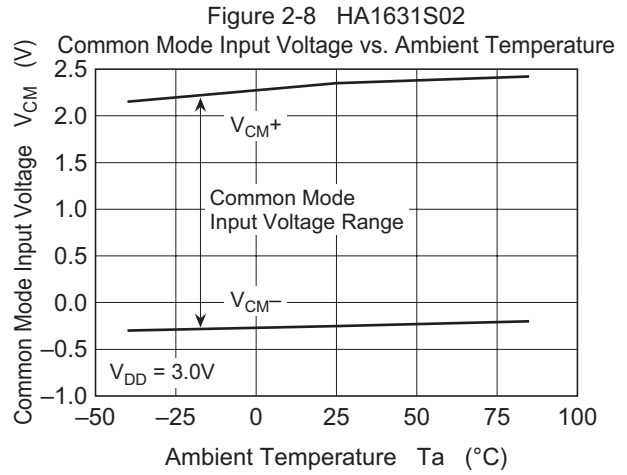
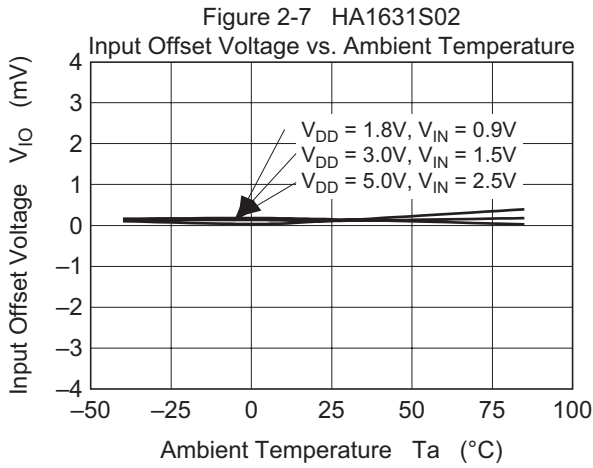

Figure 2-6 HA1631S02
Input Offset Voltage vs. Supply Voltage





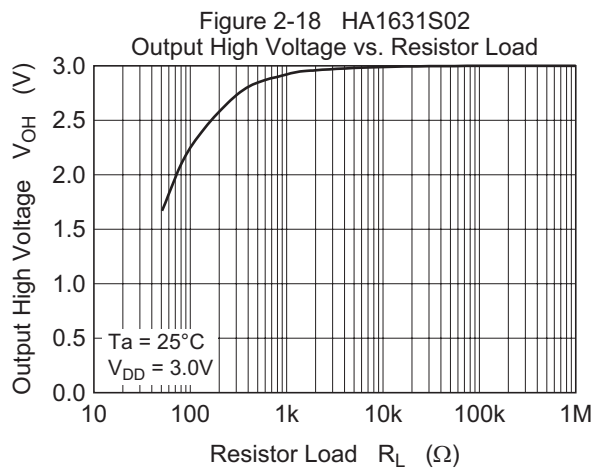
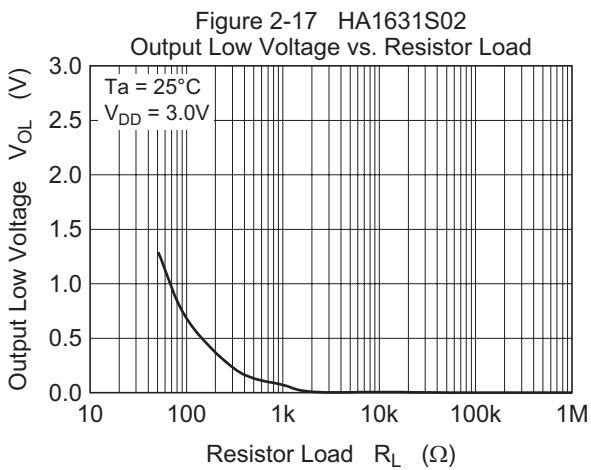
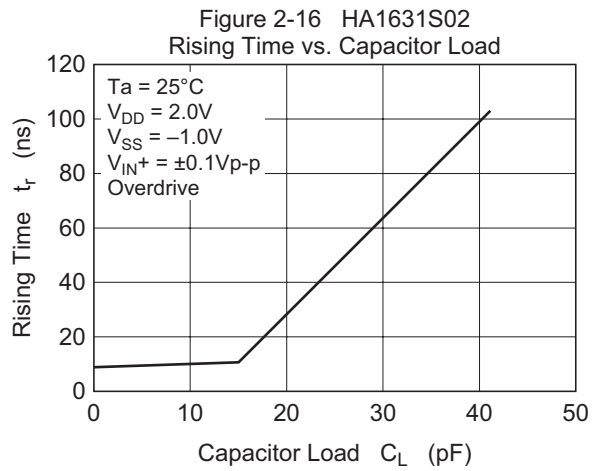
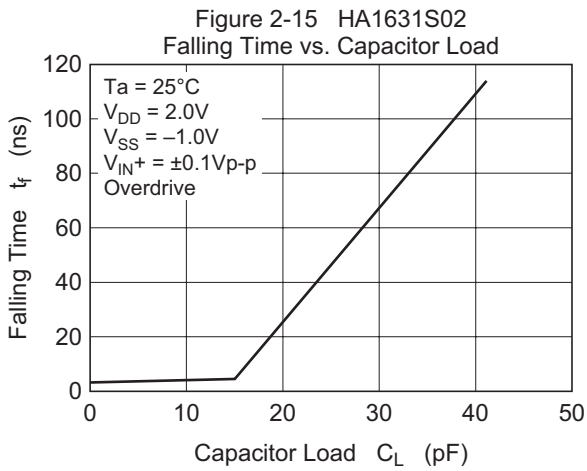
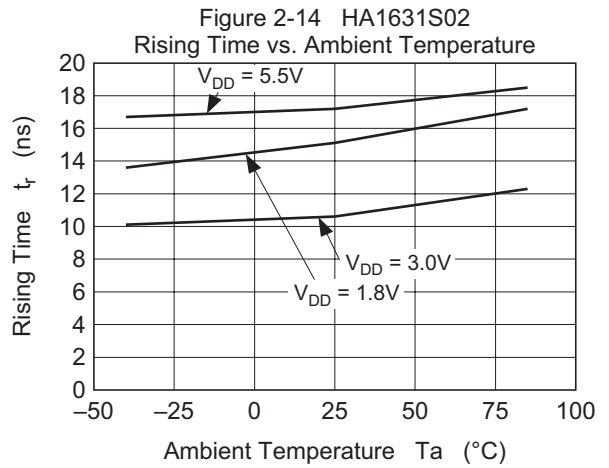
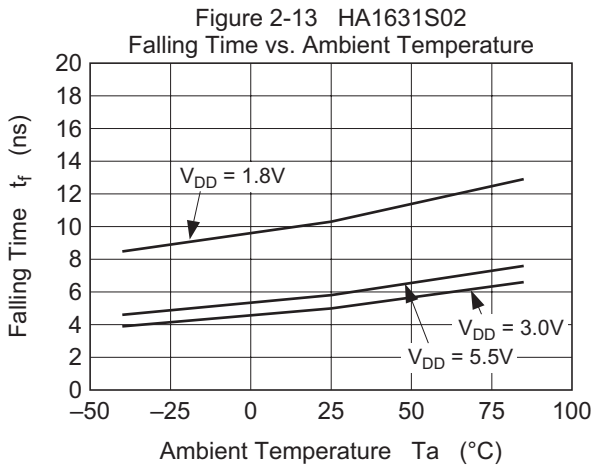

Figure 2-19 HA1631S02
Rising Time, t_r
(Overdrive = $\pm 0.1V_{p-p}$)

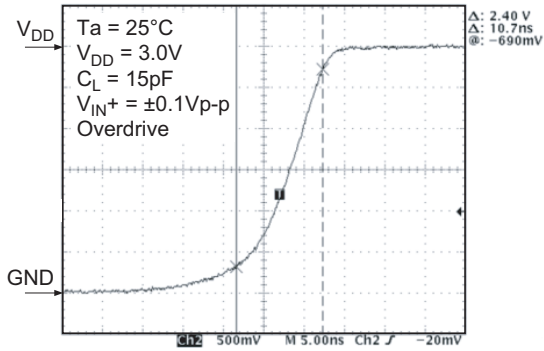

Figure 2-20 HA1631S02
Falling Time, t_f
(Overdrive = $\pm 0.1V_{p-p}$)

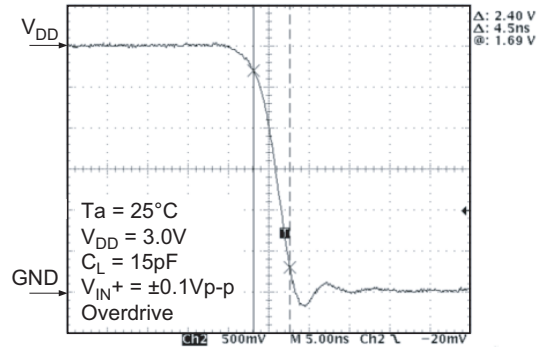

Figure 2-21 HA1631S02
 TP_{LH} Transient Response
(Overdrive = $\pm 0.1V_{p-p}$)

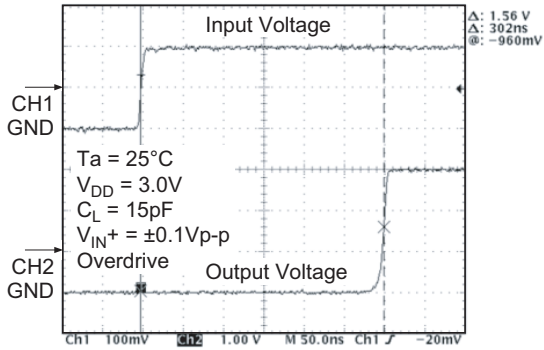

Figure 2-22 HA1631S02
 TP_{HL} Transient Response
(Overdrive = $\pm 0.1V_{p-p}$)

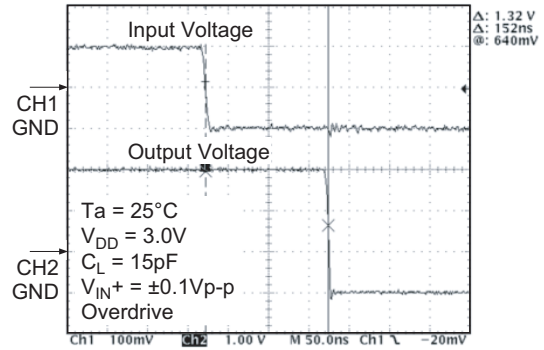

Figure 3-1 HA1631S03
Supply Current vs. Supply Voltage
(Output High)

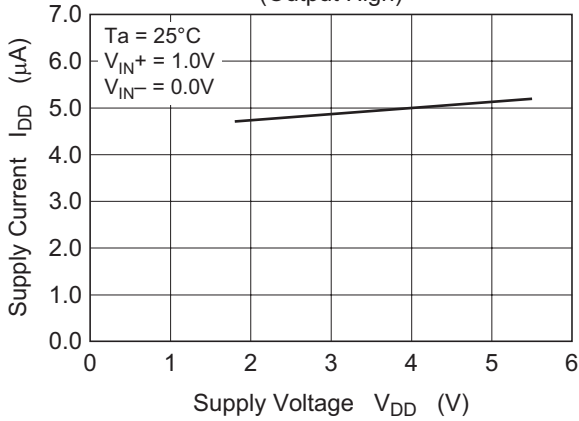

Figure 3-2 HA1631S03
Supply Current vs. Supply Voltage
(Output Low)

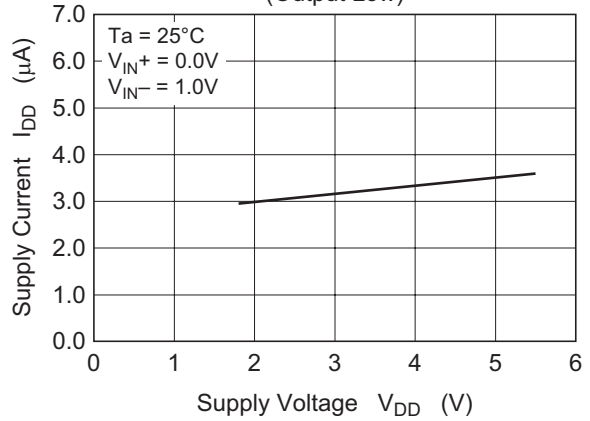

Figure 3-3 HA1631S03
Supply Current vs. Ambient Temperature

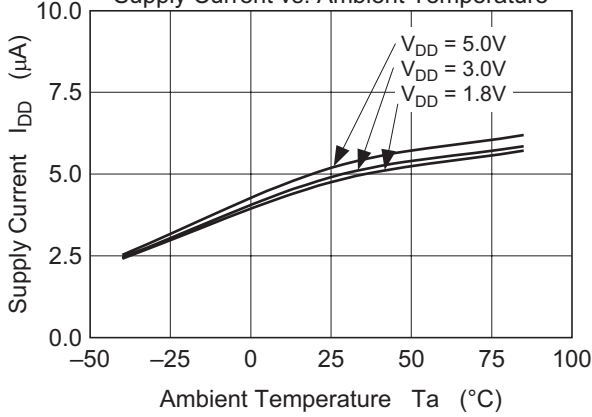

Figure 3-4 HA1631S03
Output Low Voltage vs. Output Sink Current

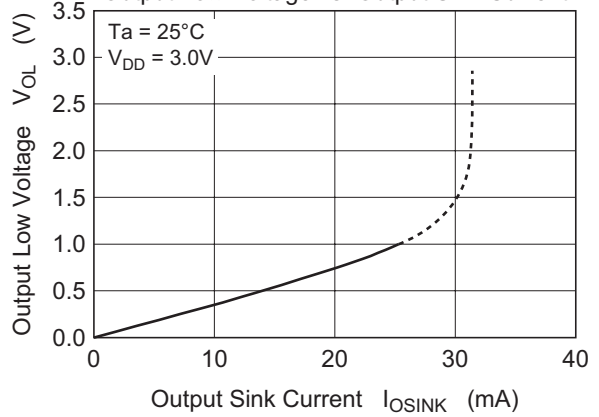

Figure 3-5 HA1631S03
Input Offset Voltage vs. Supply Voltage

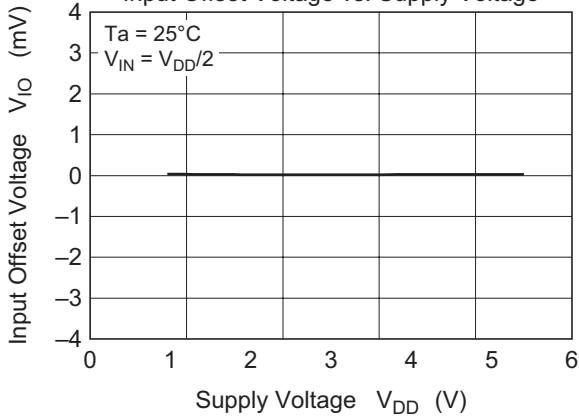
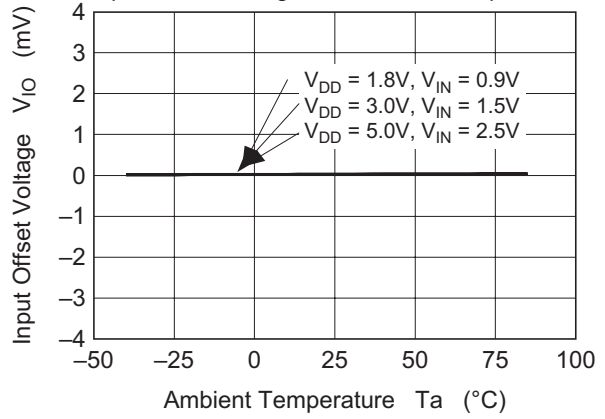
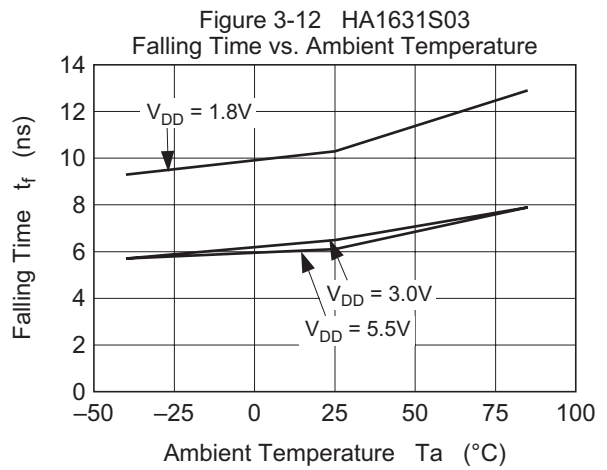
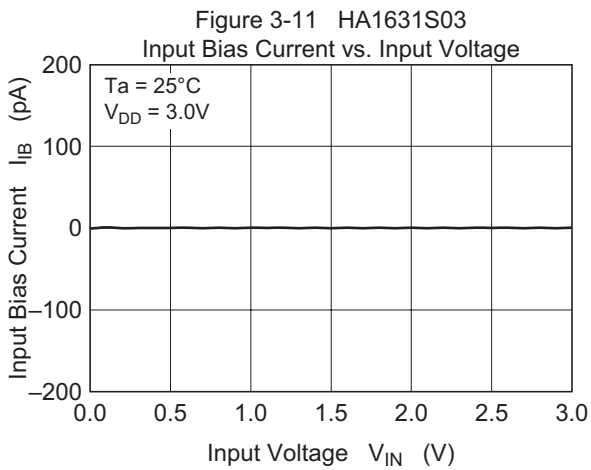
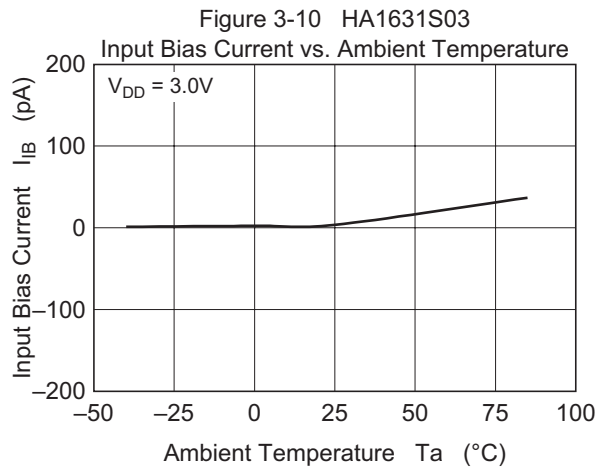
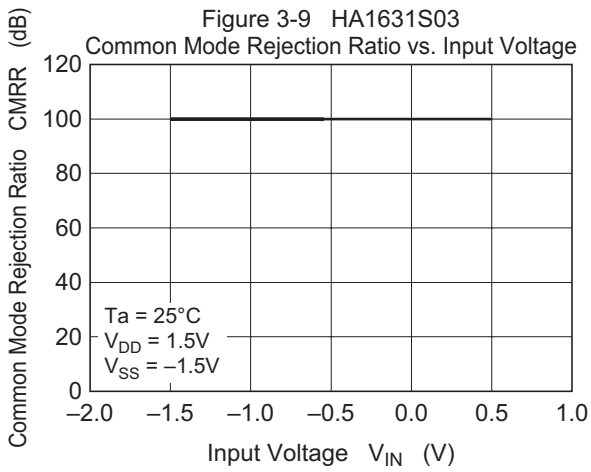
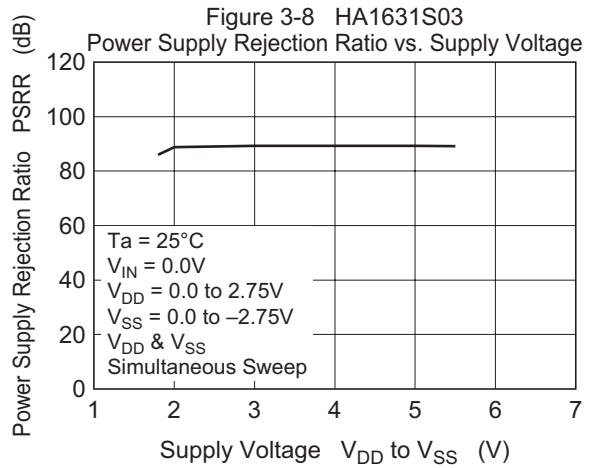
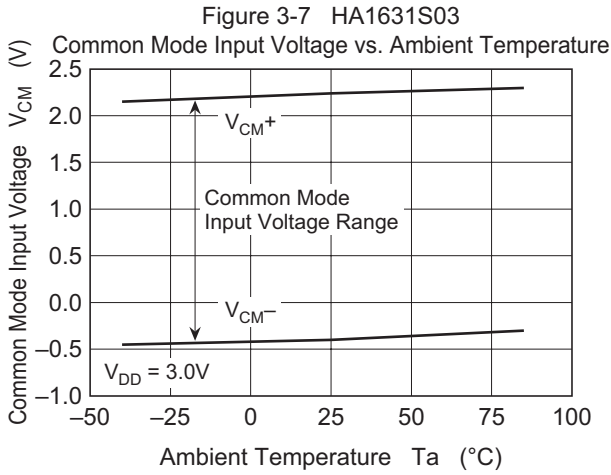

Figure 3-6 HA1631S03
Input Offset Voltage vs. Ambient Temperature





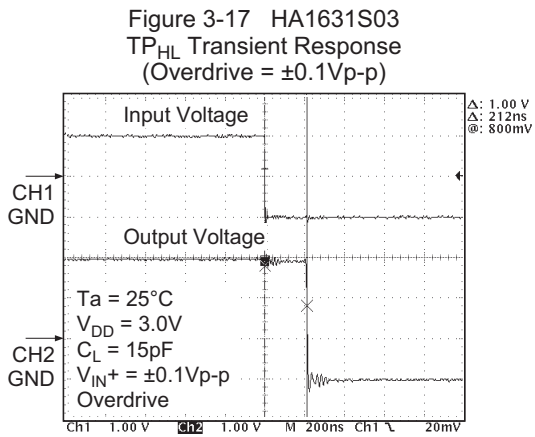
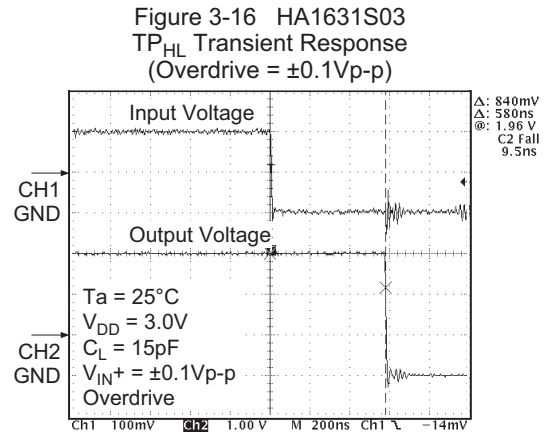
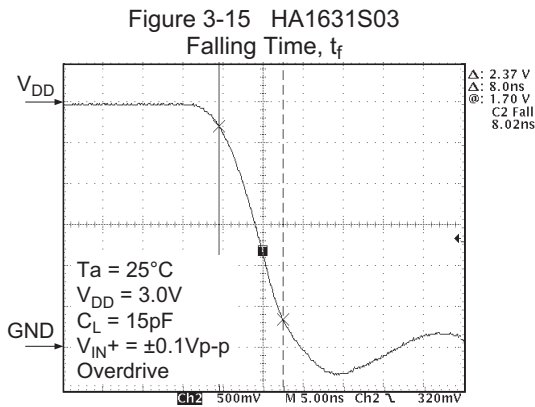
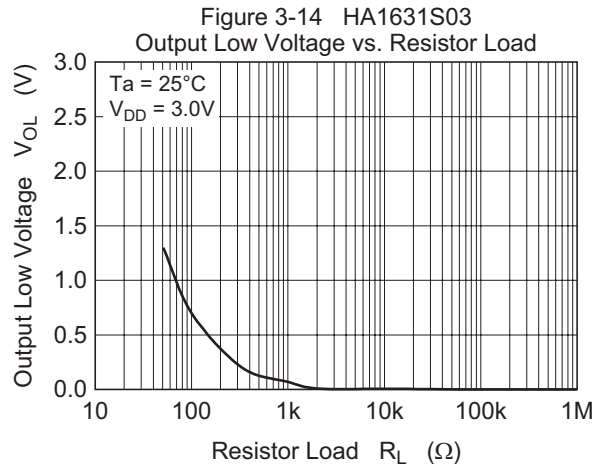
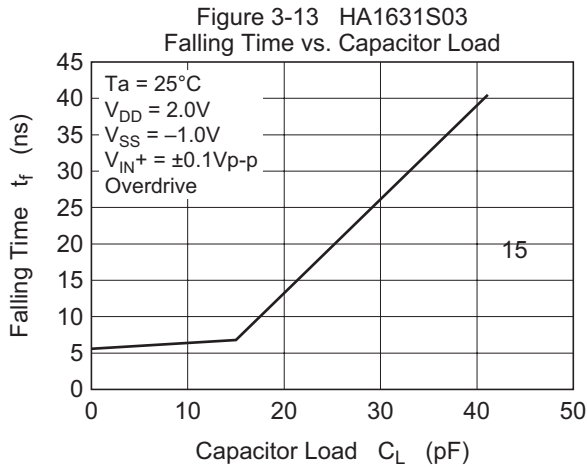

Figure 4-1 HA1631S04
Supply Current vs. Supply Voltage
(Output High)

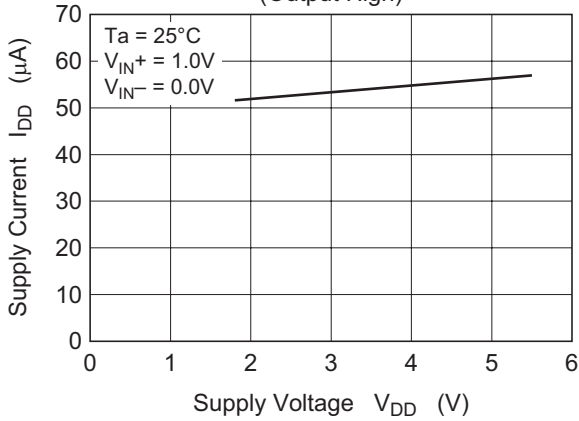

Figure 4-2 HA1631S04
Supply Current vs. Supply Voltage
(Output Low)

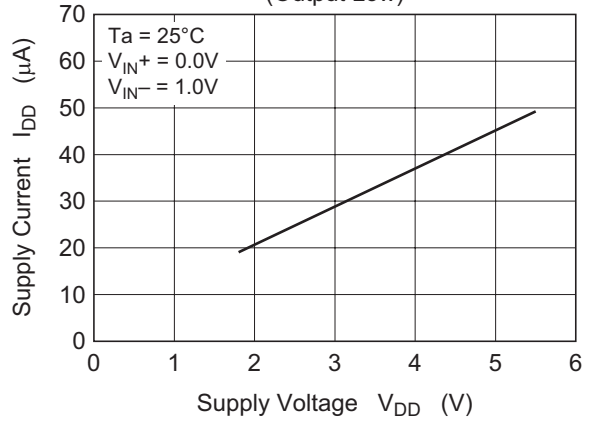

Figure 4-3 HA1631S04
Supply Current vs. Ambient Temperature

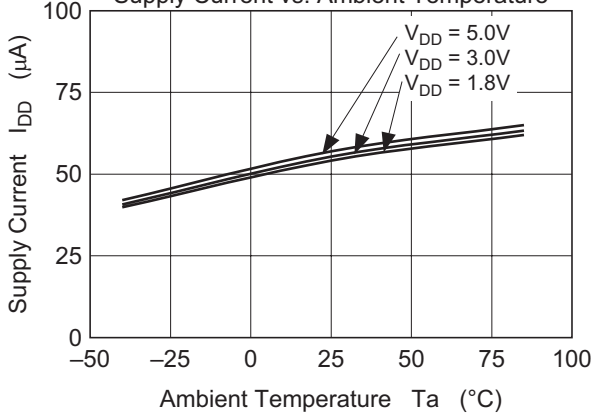

Figure 4-4 HA1631S04
Output Low Voltage vs. Output Sink Current

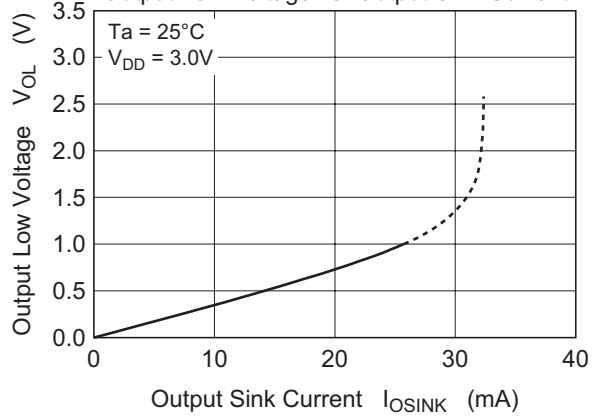

Figure 4-5 HA1631S04
Input Offset Voltage vs. Supply Voltage

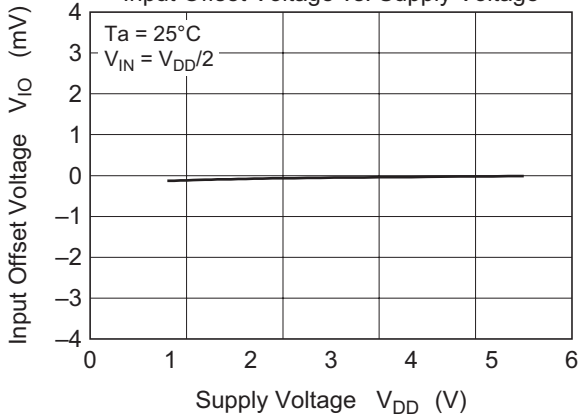
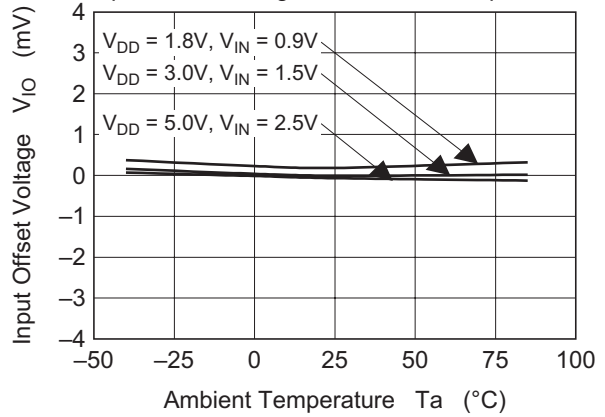
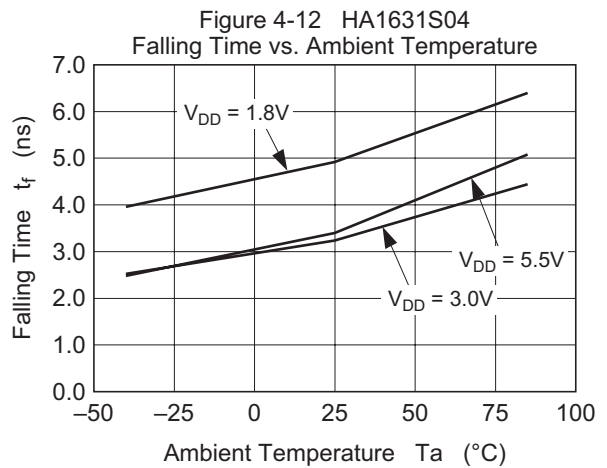
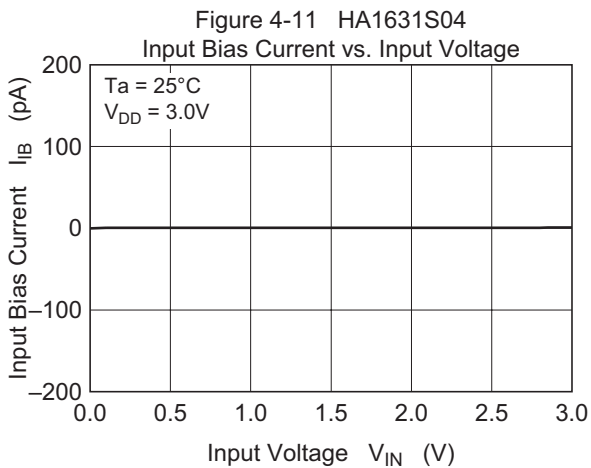
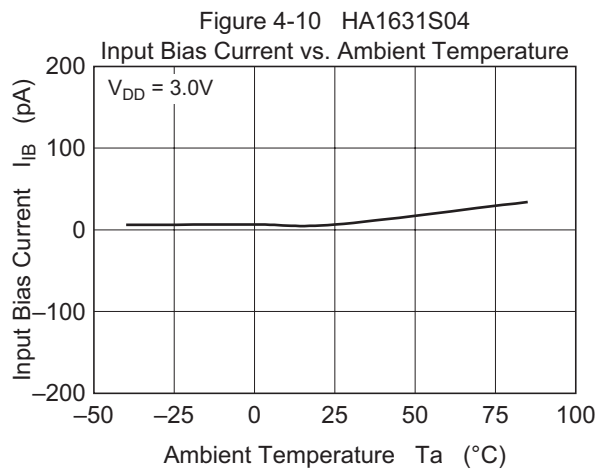
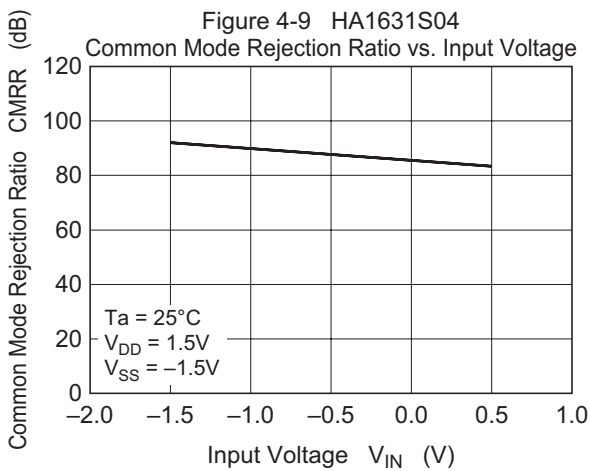
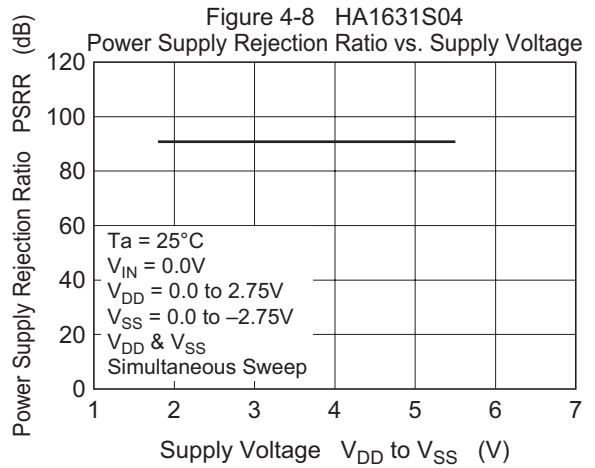
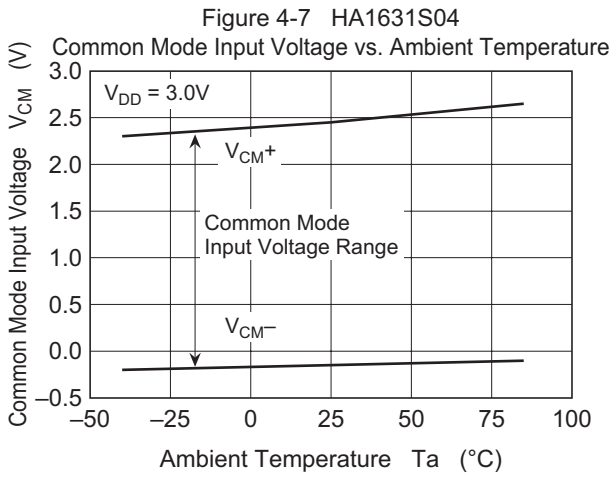
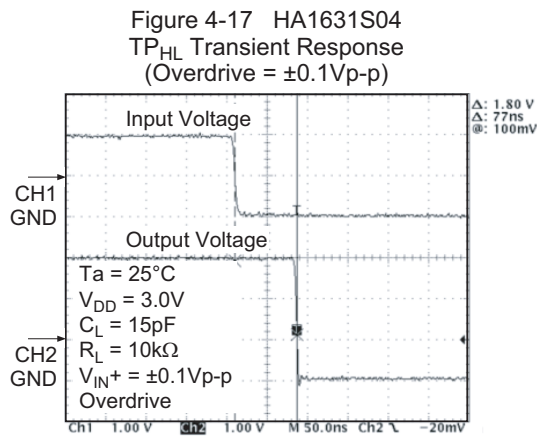
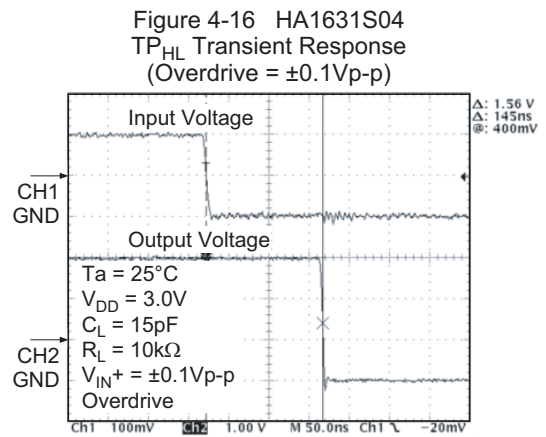
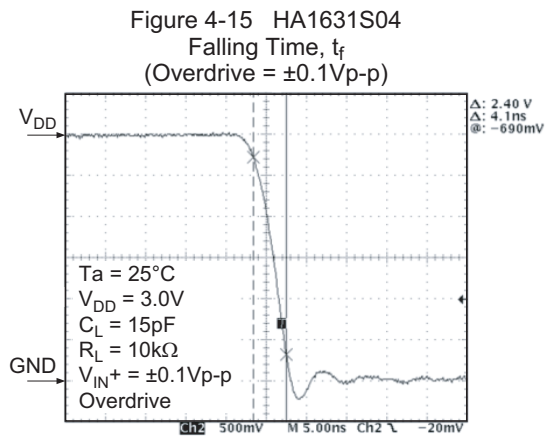
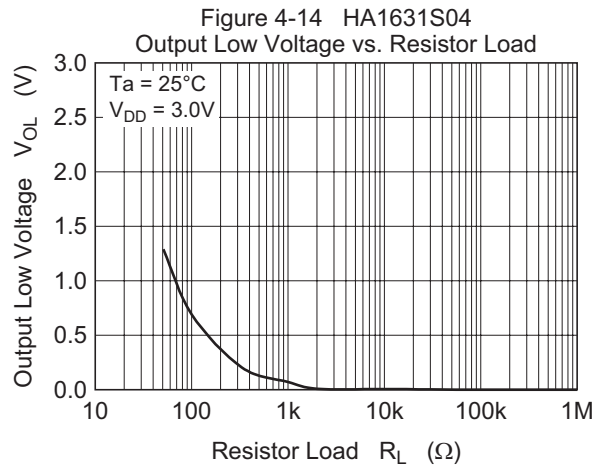
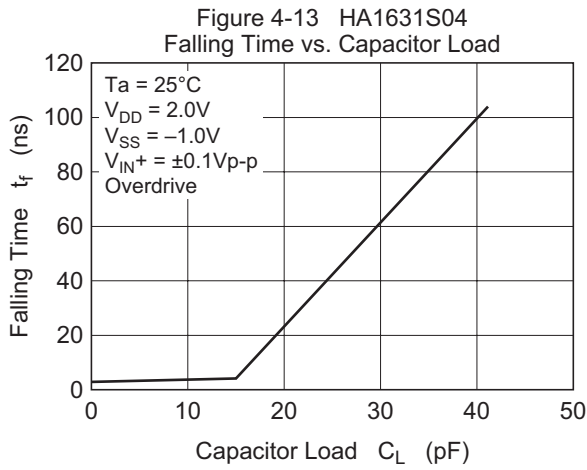

Figure 4-6 HA1631S04
Input Offset Voltage vs. Ambient Temperature







Test Circuits

1. Supply Current, I_{DD} (Output High)

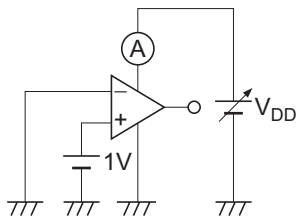

2. Supply Current, I_{DD} (Output Low)

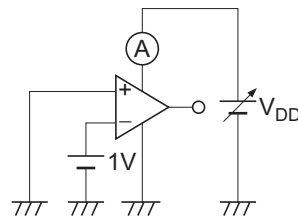

3. Output Source Current, $I_{OSOURCE}$

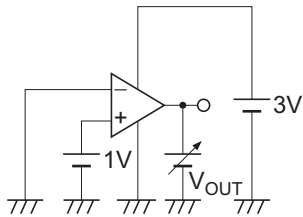

4. Output Voltage High, V_{OH}

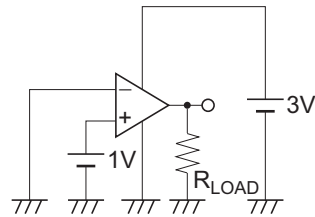

5. Output Sink Current, I_{OSINK}

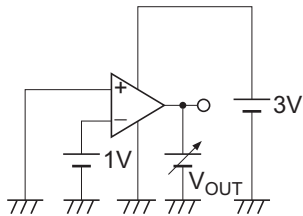

6. Output Voltage Low, V_{OL}

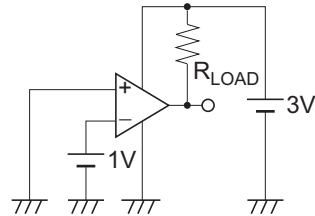

7. Input Offset Voltage, V_{IO}

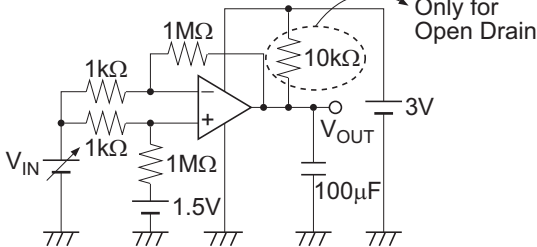

Note: $V_{IO} = V_{OUT} - 1.5V$

8. Input Offset Voltage vs. V_{DD}

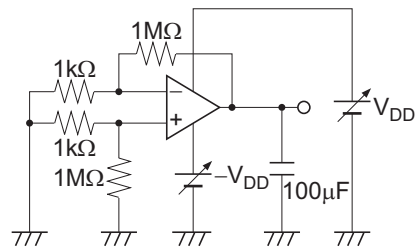

9. Common Mode Input Voltage Range, V_{CM}

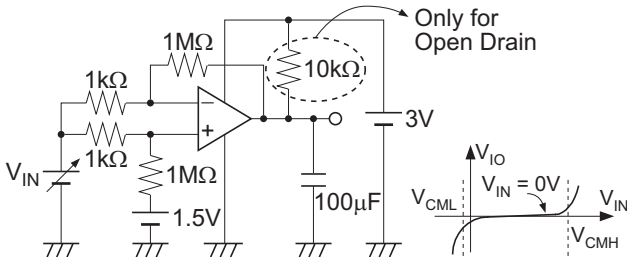

Note: V_{CML} and V_{CMH} are values of V_{IN} when V_{IO} changes more than 50dB taking $V_{IN} = 0V$ as reference.

10. Input Bias Current, I_{IB}

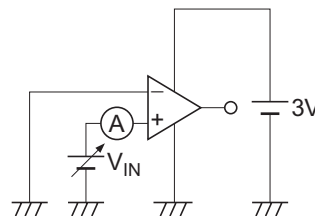

11. Power Supply Rejection Ratio, PSRR

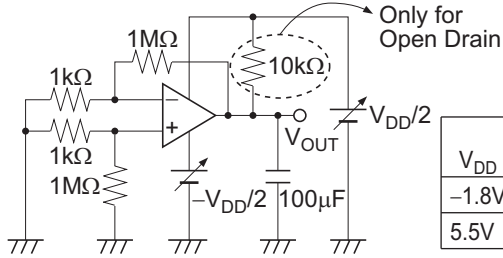

V_{DD}	Measure Point	Calculate V_{IO}	PSRR Calculation
-1.8V	V_{OUT1}	$V_{IO1} = V_{OUT1}/1000$	$PSRR = \left 20 \log_{10} \frac{ (V_{IO2} - V_{IO1}) }{5.5V - 1.8V} \right $
5.5V	V_{OUT2}	$V_{IO2} = V_{OUT2}/1000$	

12. Common Mode Rejection Ratio, CMRR

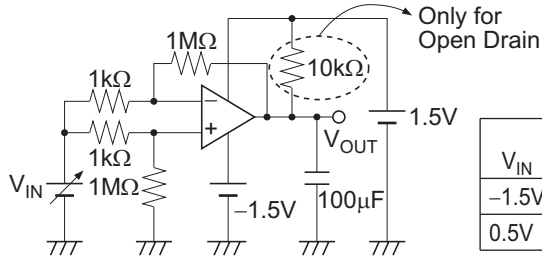

V_{IN}	Measure Point	Calculate V_{IO}	CMRR Calculation
-1.5V	V_{OUT1}	$V_{IO1} = V_{OUT1}/1000$	$CMRR = \left 20 \log_{10} \frac{ (V_{IO2} - V_{IO1}) }{0.5V - (-1.5V)} \right $
0.5V	V_{OUT2}	$V_{IO2} = V_{OUT2}/1000$	

13. Falling Time, Rising Time, Propagation Delay Time TP_{LH} , TP_{HL}

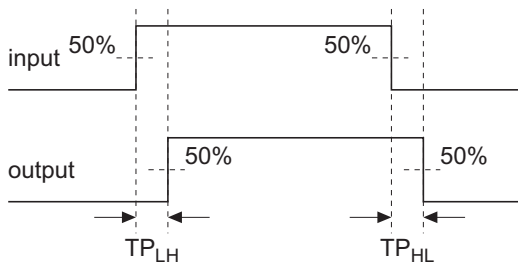
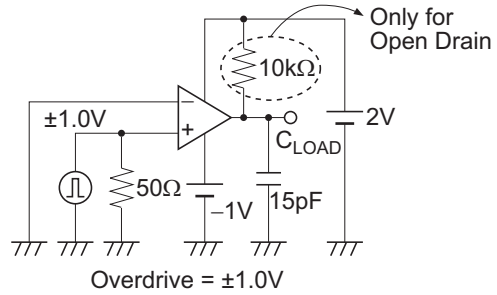
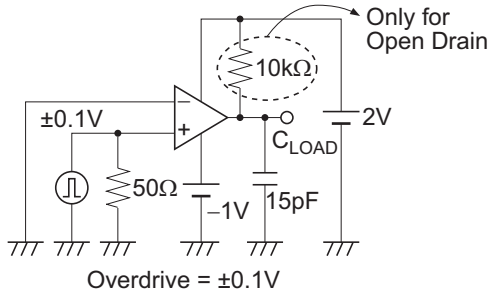

Only for Push Pull HA1631S01/02

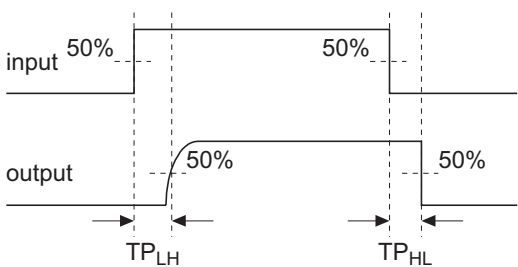
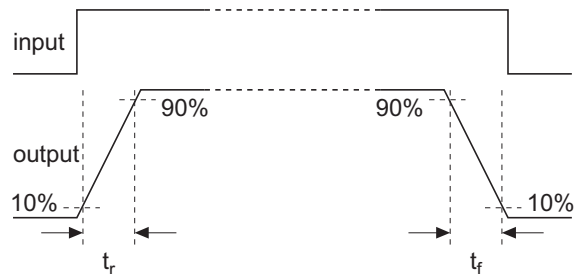

Only for Open Drain HA1631S03/04

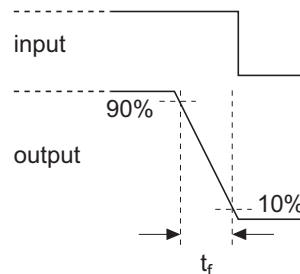

Mark Indication

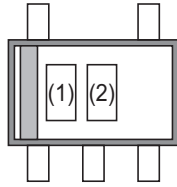

		(1)	(2)
HA1631S01CM	HA1631S01LP	0	A
HA1631S02CM	HA1631S01LP	0	B
HA1631S03CM	HA1631S01LP	0	C
HA1631S04CM	HA1631S01LP	0	D

Package Dimensions

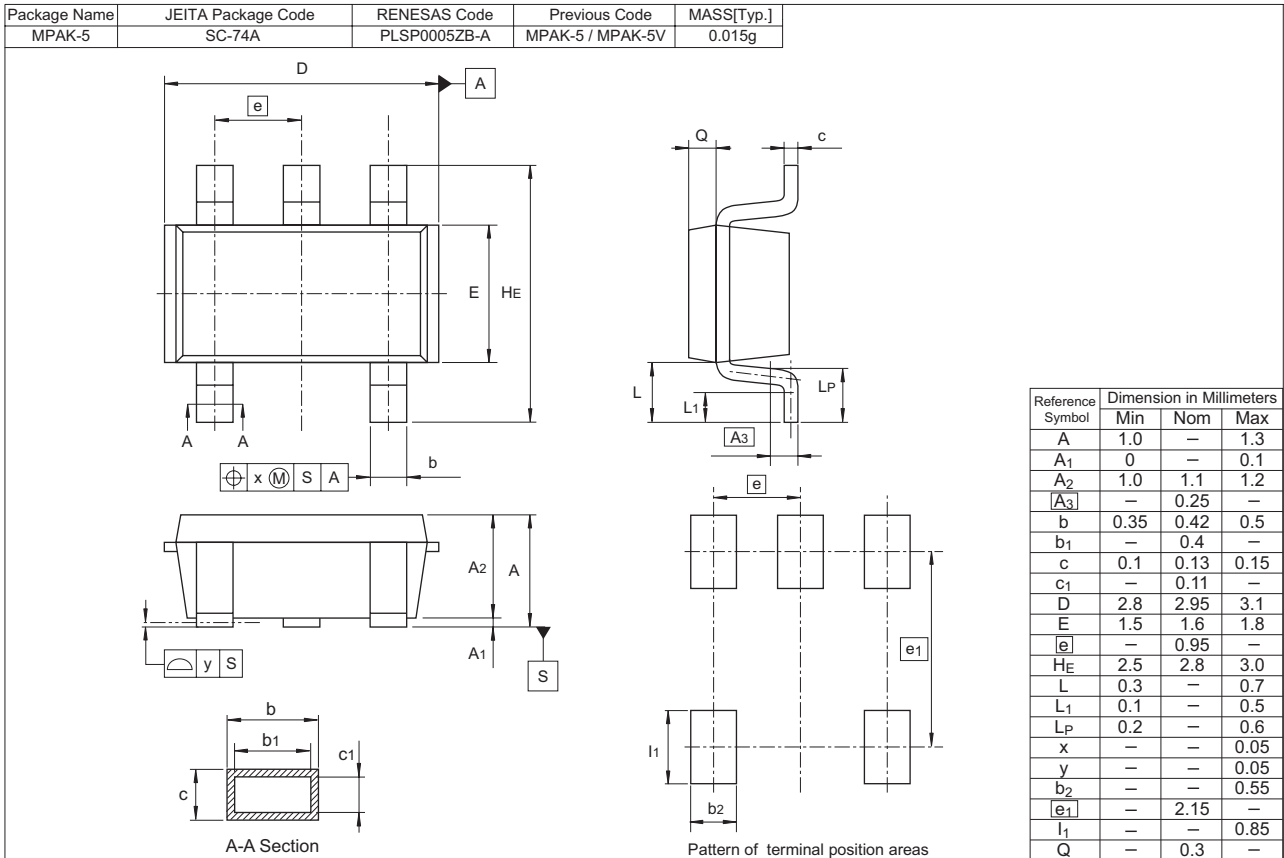
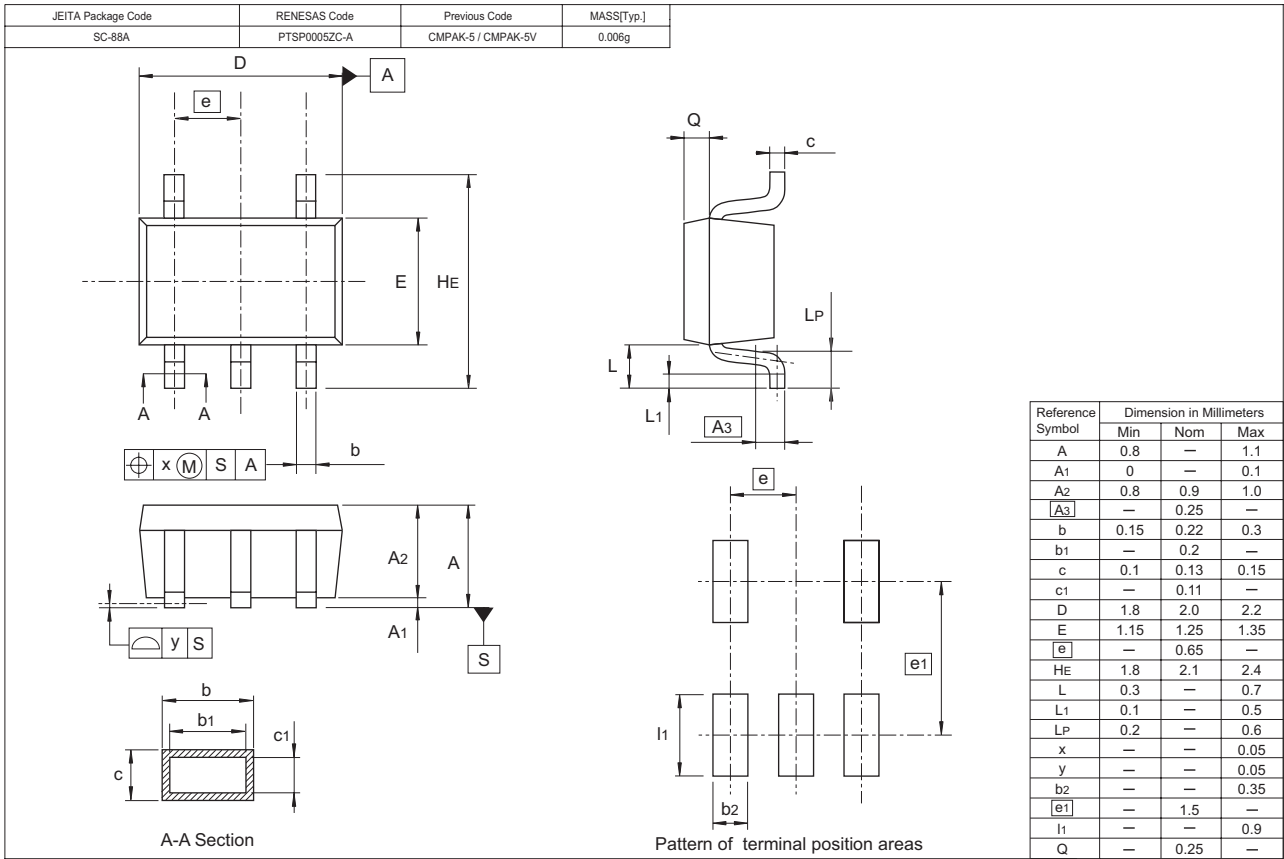

Keep safety first in your circuit designs!

1. Renesas Technology Corp. puts the maximum effort into making semiconductor products better and more reliable, but there is always the possibility that trouble may occur with them. Trouble with semiconductors may lead to personal injury, fire or property damage. Remember to give due consideration to safety when making your circuit designs, with appropriate measures such as (i) placement of substitutive, auxiliary circuits, (ii) use of nonflammable material or (iii) prevention against any malfunction or mishap.

Notes regarding these materials

1. These materials are intended as a reference to assist our customers in the selection of the Renesas Technology Corp. product best suited to the customer's application; they do not convey any license under any intellectual property rights, or any other rights, belonging to Renesas Technology Corp. or a third party.
 2. Renesas Technology Corp. assumes no responsibility for any damage, or infringement of any third-party's rights, originating in the use of any product data, diagrams, charts, programs, algorithms, or circuit application examples contained in these materials.
 3. All information contained in these materials, including product data, diagrams, charts, programs and algorithms represents information on products at the time of publication of these materials, and are subject to change by Renesas Technology Corp. without notice due to product improvements or other reasons. It is therefore recommended that customers contact Renesas Technology Corp. or an authorized Renesas Technology Corp. product distributor for the latest product information before purchasing a product listed herein.
The information described here may contain technical inaccuracies or typographical errors.
Renesas Technology Corp. assumes no responsibility for any damage, liability, or other loss rising from these inaccuracies or errors.
Please also pay attention to information published by Renesas Technology Corp. by various means, including the Renesas Technology Corp. Semiconductor home page (<http://www.renesas.com>).
 4. When using any or all of the information contained in these materials, including product data, diagrams, charts, programs, and algorithms, please be sure to evaluate all information as a total system before making a final decision on the applicability of the information and products. Renesas Technology Corp. assumes no responsibility for any damage, liability or other loss resulting from the information contained herein.
 5. Renesas Technology Corp. semiconductors are not designed or manufactured for use in a device or system that is used under circumstances in which human life is potentially at stake. Please contact Renesas Technology Corp. or an authorized Renesas Technology Corp. product distributor when considering the use of a product contained herein for any specific purposes, such as apparatus or systems for transportation, vehicular, medical, aerospace, nuclear, or undersea repeater use.
 6. The prior written approval of Renesas Technology Corp. is necessary to reprint or reproduce in whole or in part these materials.
 7. If these products or technologies are subject to the Japanese export control restrictions, they must be exported under a license from the Japanese government and cannot be imported into a country other than the approved destination.
Any diversion or reexport contrary to the export control laws and regulations of Japan and/or the country of destination is prohibited.
 8. Please contact Renesas Technology Corp. for further details on these materials or the products contained therein.
-



RENESAS SALES OFFICES

<http://www.renesas.com>

Refer to "<http://www.renesas.com/en/network>" for the latest and detailed information.

Renesas Technology America, Inc.

450 Holger Way, San Jose, CA 95134-1368, U.S.A
Tel: <1> (408) 382-7500, Fax: <1> (408) 382-7501

Renesas Technology Europe Limited

Dukes Meadow, Millboard Road, Bourne End, Buckinghamshire, SL8 5FH, U.K.
Tel: <44> (1628) 585-100, Fax: <44> (1628) 585-900

Renesas Technology (Shanghai) Co., Ltd.

Unit 204, 205, AZIACenter, No.1233 Lujiazui Ring Rd, Pudong District, Shanghai, China 200120
Tel: <86> (21) 5877-1818, Fax: <86> (21) 6887-7898

Renesas Technology Hong Kong Ltd.

7th Floor, North Tower, World Finance Centre, Harbour City, 1 Canton Road, Tsimshatsui, Kowloon, Hong Kong
Tel: <852> 2265-6688, Fax: <852> 2730-6071

Renesas Technology Taiwan Co., Ltd.

10th Floor, No.99, Fushing North Road, Taipei, Taiwan
Tel: <886> (2) 2715-2888, Fax: <886> (2) 2713-2999

Renesas Technology Singapore Pte. Ltd.

1 Harbour Front Avenue, #06-10, Keppel Bay Tower, Singapore 098632
Tel: <65> 6213-0200, Fax: <65> 6278-8001

Renesas Technology Korea Co., Ltd.

Kukje Center Bldg. 18th Fl., 191, 2-ka, Hangang-ro, Yongsan-ku, Seoul 140-702, Korea
Tel: <82> (2) 796-3115, Fax: <82> (2) 796-2145

Renesas Technology Malaysia Sdn. Bhd

Unit 906, Block B, Menara Amcorp, Amcorp Trade Centre, No.18, Jalan Persiaran Barat, 46050 Petaling Jaya, Selangor Darul Ehsan, Malaysia
Tel: <603> 7955-9390, Fax: <603> 7955-9510