

RoHS Compliant



CATV Diplex Filter
5 - 42 / 54 - 1000MHz

MAFL-007654-CD0A10
V2

Features

- 75 Ohm
- SMT unit
- Low Cost, Low Profile
- RoHS* Compliant

Description

M/A-COM's MAFL-007654-CD0A10 is a low cost, low profile diplex filter designed for use in CATV set-top-box and cable modem applications. Technology used in this design is patent pending.

Functional Schematic

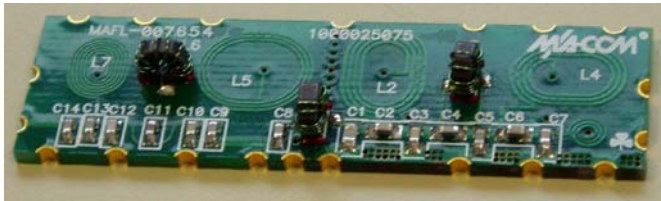
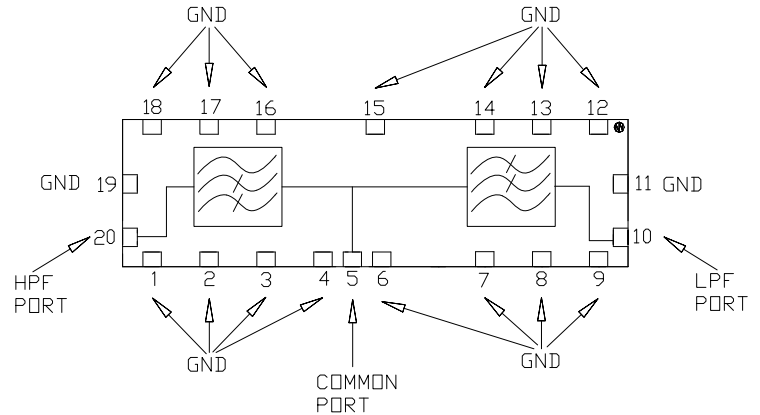

Pin Configuration

Function	Pin Number
Common Port	5
Low Pass Port	10
Output Port	20
Ground	1-4, 6-9, 11-19
Not connected	-

Absolute Maximum Ratings ^{1,2}

Parameter	Absolute Maximum
RF Power	250mW
DC Current	30mA
Operating Temperature	-40°C to +85°C
Storage Temperature	-40°C to +85°C

1. Exceeding any one or combination of these limits may cause permanent damage to this device.
2. M/A-COM does not recommend sustained operation near these survivability limits.

* Restrictions on Hazardous Substances, European Union Directive 2002/95/EC.

CATV Diplex Filter
5 - 42 / 54 - 1000MHz

MAFL-007654-CD0A10
V2

SM-161 Case Style

Sm-161 Case Style

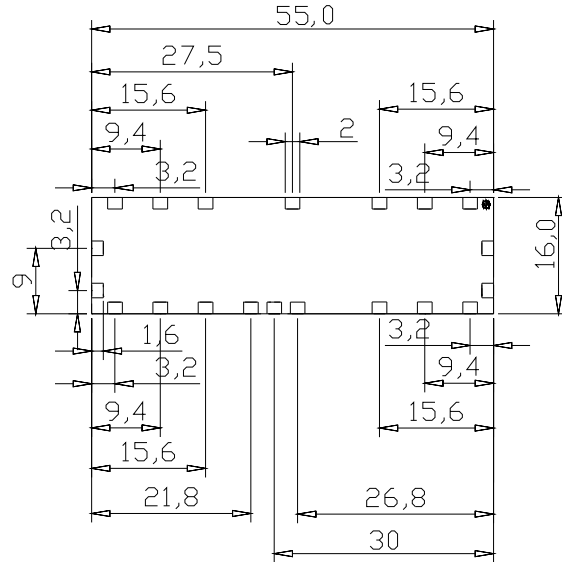
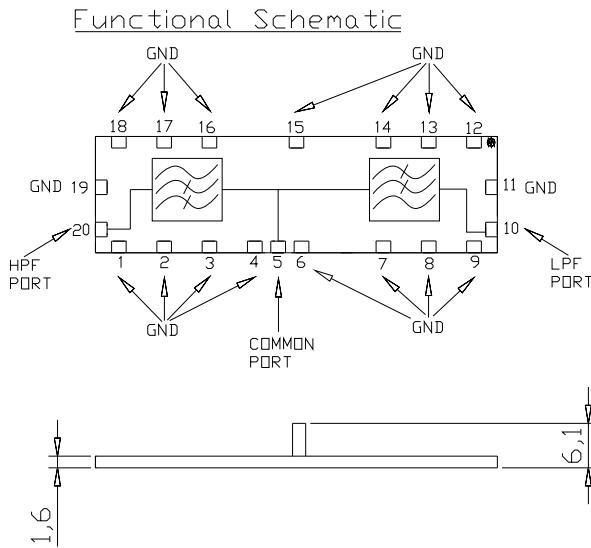

Dimensions in mm. Tolerance: .x ± 0.1, .xx ± 0.05

Recommended PCB Configuration

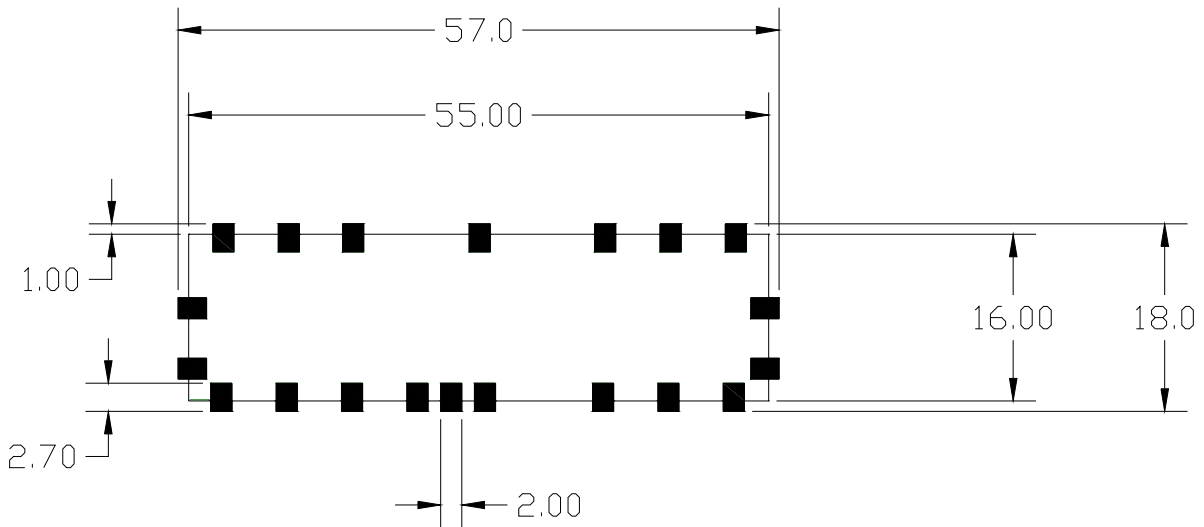

Dimensions in mm. Tolerance: .x ± 0.1, .xx ± 0.05

CATV Diplex Filter
5 - 42 / 54 - 1000MHz

MAFL-007654-CD0A10
V2

Electrical Specifications: $T_A = 25^\circ\text{C}$, $Z_0 = 75\Omega$ ¹

Parameter	Test Conditions	Units	Min	Typ	Max
Frequency Range	5 - 42MHz / 54 - 1000MHz				
Insertion Loss Rejection ³	5 - 42MHz	dB	-	-0.5	-1.1
	54 - 60MHz	dB	-53	-55	-
	60 - 200MHz	dB	-55	-58	-
Insertion Loss	54 - 60MHz	dB	-	-1.1	-1.3
	60 - 1000MHz	dB	-	-0.5	-1.1
Filter Isolation	5 - 39.5MHz	dB	-55	-62	-
	39.5 - 42MHz	dB	-48	-55	-
Filter Isolation	54 - 60MHz	dB	-53	-55	-
	60 - 500MHz	dB	-55	-58	-
	500 - 860MHz	db	-50	-55	-
	860 - 1000MHz	dB	-45	-50	-
Input Return Loss	5 - 42MHz	dB	-14	-17	-
Input Return Loss	54 - 64MHz	dB	-10	-14	-
	64 - 74MHz	dB	-12	16	-
	74 - 650MHz	dB	-15	20	-
	650 - 1000MHz	dB	-14	16	-

3. LFP rejection measured at 53.25MHz to guarantee 53dB min. rejection

CATV Diplex Filter
5 - 42 / 54 - 1000MHz

MAFL-007654-CD0A10

V2

Typical Performance Curves

Input Return Loss

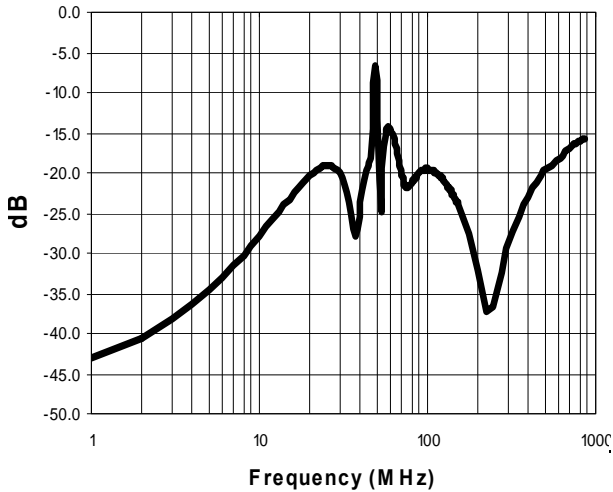

Filter Isolation

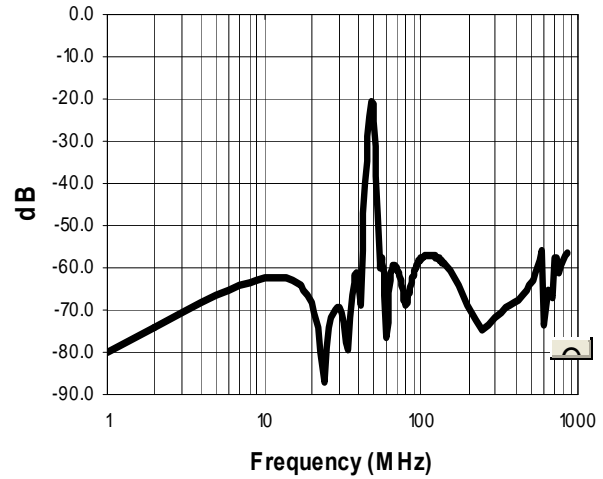

Low Pass Filter Insertion Loss

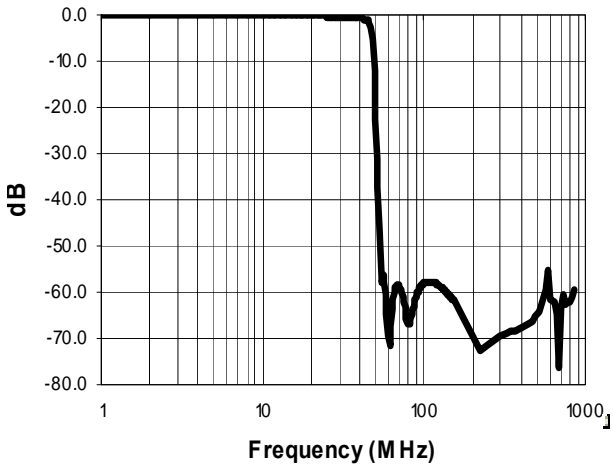

High Pass Filter Insertion Loss

