

# SKM 400GB125D

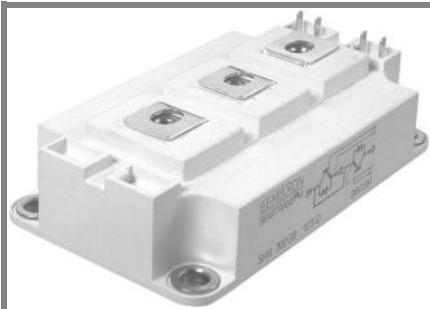

**SEMITRANS® 3**

## Ultra Fast IGBT Modules

**SKM 400GB125D**

**SKM 400GAL125D**

**SKM 400GAR125D**

### Features

- Low inductance case
- Short tail current with low temperature dependence
- High short circuit capability, self limiting to  $6 \times I_{Cnom}$
- Fast & soft inverse CAL diodes
- Isolated copper baseplate using DBC Direct Copper Bonding Technology
- Large clearance (13 mm) and creepage distances (20 mm)

### Typical Applications

- Switched mode power supplies at  $f_{sw} > 20\text{kHz}$
- Resonant inverters up to 100 kHz
- Inductive heating
- Electronic welders at  $f_{sw} > 20\text{kHz}$

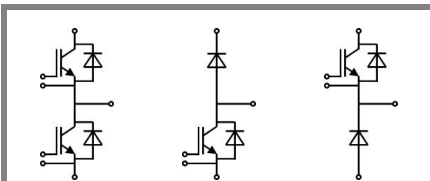

**GB**

**GAL**

**GAR**

Absolute Maximum Ratings		$T_c = 25\text{ }^\circ\text{C}$ , unless otherwise specified			
Symbol	Conditions	Values		Units	
<b>IGBT</b>					
$V_{CES}$	$T_j = 25\text{ }^\circ\text{C}$	1200		V	
$I_C$	$T_j = 150\text{ }^\circ\text{C}$	$T_{case} = 25\text{ }^\circ\text{C}$	400	A	
		$T_{case} = 80\text{ }^\circ\text{C}$	300	A	
$I_{CRM}$	$I_{CRM} = 2 \times I_{Cnom}$	600		A	
$V_{GES}$		$\pm 20$		V	
$t_{psc}$	$V_{CC} = 600\text{ V}; V_{GE} \leq 20\text{ V}; T_j = 125\text{ }^\circ\text{C}$ $V_{CES} < 1200\text{ V}$	10		$\mu\text{s}$	
<b>Inverse Diode</b>					
$I_F$	$T_j = 150\text{ }^\circ\text{C}$	$T_{case} = 25\text{ }^\circ\text{C}$	390	A	
		$T_{case} = 80\text{ }^\circ\text{C}$	260	A	
$I_{FRM}$	$I_{FRM} = 2 \times I_{Fnom}$	600		A	
$I_{FSM}$	$t_p = 10\text{ ms}; \text{sin.}$	$T_j = 150\text{ }^\circ\text{C}$	2880		A
<b>Freewheeling Diode</b>					
$I_F$	$T_j = 150\text{ }^\circ\text{C}$	$T_{case} = 25\text{ }^\circ\text{C}$	390	A	
		$T_{case} = 80\text{ }^\circ\text{C}$	260	A	
$I_{FRM}$	$I_{FRM} = 2 \times I_{Fnom}$	600		A	
$I_{FSM}$	$t_p = 10\text{ ms}; \text{sin.}$	$T_j = 150\text{ }^\circ\text{C}$	2880		A
<b>Module</b>					
$I_{t(RMS)}$		500		A	
$T_{vj}$		- 40...+ 150		$^\circ\text{C}$	
$T_{stg}$		- 40...+ 125		$^\circ\text{C}$	
$V_{isol}$	AC, 1 min.	4000		V	

Characteristics		$T_c = 25\text{ }^\circ\text{C}$ , unless otherwise specified			
Symbol	Conditions	min.	typ.	max.	Units
<b>IGBT</b>					
$V_{GE(th)}$	$V_{GE} = V_{CE}, I_C = 12\text{ mA}$	4,5	5,5	6,5	V
$I_{CES}$	$V_{GE} = 0\text{ V}, V_{CE} = V_{CES}$		0,15	0,45	mA
$V_{CE0}$		$T_j = 25\text{ }^\circ\text{C}$	1,4		V
		$T_j = 125\text{ }^\circ\text{C}$	1,7		V
$r_{CE}$	$V_{GE} = 15\text{ V}$	$T_j = 25\text{ }^\circ\text{C}$	6,3		m $\Omega$
		$T_j = 125\text{ }^\circ\text{C}$	7,6		m $\Omega$
$V_{CE(sat)}$	$I_{Cnom} = 300\text{ A}, V_{GE} = 15\text{ V}$	$T_j = 25\text{ }^\circ\text{C}_{chiplev.}$	3,3	3,85	V
		$T_j = 125\text{ }^\circ\text{C}_{chiplev.}$	4	4,55	V
$C_{ies}$	$V_{CE} = 25, V_{GE} = 0\text{ V}$	$f = 1\text{ MHz}$	22		nF
$C_{oes}$			3,3		nF
$C_{res}$			1,2		nF
$Q_G$	$V_{GE} = 0\text{ V} - +20\text{ V}$	2650		nC	
$R_{Gint}$	$T_j = \text{ }^\circ\text{C}$	1,25		$\Omega$	
$t_{d(on)}$	$R_{Gon} = 2\text{ }^\circ\Omega$	$V_{CC} = 600\text{ V}$ $I_C = 300\text{ A}$	70		ns
			$T_j = 125\text{ }^\circ\text{C}$	50	
$E_{on}$	$R_{Goff} = 2\text{ }^\circ\Omega$	$V_{GE} = \pm 15\text{ V}$	17		mJ
$t_{d(off)}$			500		ns
$t_f$			32		ns
$E_{off}$			18		mJ
$R_{th(j-c)}$	per IGBT			0,05	K/W

# SKM 400GB125D

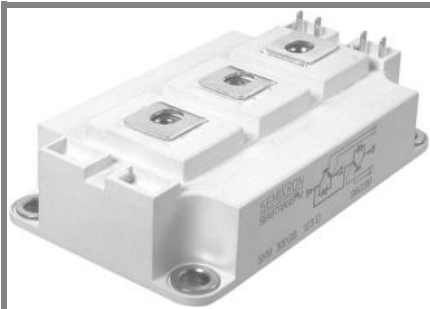

**SEMITRANS<sup>®</sup> 3**

## Ultra Fast IGBT Modules

**SKM 400GB125D**

**SKM 400GAL125D**

**SKM 400GAR125D**

### Features

- Low inductance case
- Short tail current with low temperature dependence
- High short circuit capability, self limiting to  $6 \times I_{cnom}$
- Fast & soft inverse CAL diodes
- Isolated copper baseplate using DBC Direct Copper Bonding Technology
- Large clearance (13 mm) and creepage distances (20 mm)

### Typical Applications

- Switched mode power supplies at  $f_{sw} > 20\text{kHz}$
- Resonant inverters up to 100 kHz
- Inductive heating
- Electronic welders at  $f_{sw} > 20\text{ kHz}$

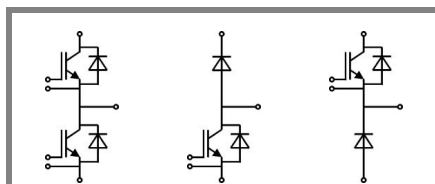

GB

GAL

GAR

Characteristics					
Symbol	Conditions	min.	typ.	max.	Units
<b>Inverse Diode</b>					
$V_F = V_{EC}$	$I_{Fnom} = 300\text{ A}; V_{GE} = 0\text{ V}$	$T_j = 25\text{ }^\circ\text{C}_{chiplev.}$	2	2,5	V
		$T_j = 125\text{ }^\circ\text{C}_{chiplev.}$	1,8		V
$V_{F0}$		$T_j = 25\text{ }^\circ\text{C}$	1,1	1,2	V
		$T_j = 125\text{ }^\circ\text{C}$			V
$r_F$		$T_j = 25\text{ }^\circ\text{C}$	3	4,3	mΩ
		$T_j = 125\text{ }^\circ\text{C}$			mΩ
$I_{RRM}$	$I_F = 300\text{ A}$	$T_j = 125\text{ }^\circ\text{C}$	350		A
$Q_{rr}$	$di/dt = 8300\text{ A}/\mu\text{s}$		45		μC
$E_{rr}$	$V_{GE} = 0\text{ V}; V_{CC} = 600\text{ V}$		16		mJ
$R_{th(j-c)D}$	per diode			0,125	K/W
<b>Freewheeling Diode</b>					
$V_F = V_{EC}$	$I_{Fnom} = 300\text{ A}; V_{GE} = 0\text{ V}$	$T_j = 25\text{ }^\circ\text{C}_{chiplev.}$	2	2,5	V
		$T_j = 125\text{ }^\circ\text{C}_{chiplev.}$	1,8		V
$V_{F0}$		$T_j = 25\text{ }^\circ\text{C}$	1,1	1,2	V
		$T_j = 125\text{ }^\circ\text{C}$			V
$r_F$		$T_j = 25\text{ }^\circ\text{C}$	3	4,3	V
		$T_j = 125\text{ }^\circ\text{C}$			V
$I_{RRM}$	$I_F = 300\text{ A}$	$T_j = 125\text{ }^\circ\text{C}$	350		A
$Q_{rr}$	$di/dt = 8300\text{ A}/\mu\text{s}$		45		μC
$E_{rr}$	$V_{GE} = 0\text{ V}; V_{CC} = 600\text{ V}$		16		mJ
$R_{th(j-c)FD}$	per diode			0,125	K/W
<b>Module</b>					
$L_{CE}$			15	20	nH
$R_{CC'+EE'}$	res., terminal-chip	$T_{case} = 25\text{ }^\circ\text{C}$	0,35		mΩ
		$T_{case} = 125\text{ }^\circ\text{C}$	0,5		mΩ
$R_{th(c-s)}$	per module			0,038	K/W
$M_s$	to heat sink M6		3	5	Nm
$M_t$	to terminals M6		2,5	5	Nm
w				325	g

This is an electrostatic discharge sensitive device (ESDS), international standard IEC 60747-1, Chapter IX.

This technical information specifies semiconductor devices but promises no characteristics. No warranty or guarantee expressed or implied is made regarding delivery, performance or suitability.

# SKM 400GB125D

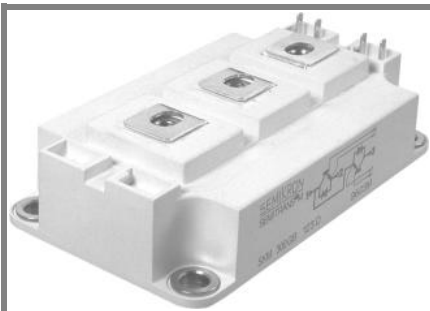

**SEMITRANS® 3**

## Ultra Fast IGBT Modules

**SKM 400GB125D**

**SKM 400GAL125D**

**SKM 400GAR125D**

### Features

- Low inductance case
- Short tail current with low temperature dependence
- High short circuit capability, self limiting to  $6 \times I_{cnom}$
- Fast & soft inverse CAL diodes
- Isolated copper baseplate using DBC Direct Copper Bonding Technology
- Large clearance (13 mm) and creepage distances (20 mm)

### Typical Applications

- Switched mode power supplies at  $f_{sw} > 20\text{kHz}$
- Resonant inverters up to 100 kHz
- Inductive heating
- Electronic welders at  $f_{sw} > 20\text{ kHz}$

$Z_{th}$		Conditions	Values	Units
<b>Symbol</b>				
$Z_{th(j-c)I}$				
$R_{\theta j-c}$	$i = 1$		36	mk/W
$R_{\theta j-c}$	$i = 2$		10,5	mk/W
$R_{\theta j-c}$	$i = 3$		3	mk/W
$R_{\theta j-c}$	$i = 4$		0,5	mk/W
$\tau_{th(j-c)I}$	$i = 1$		0,0744	s
$\tau_{th(j-c)I}$	$i = 2$		0,0078	s
$\tau_{th(j-c)I}$	$i = 3$		0,0016	s
$\tau_{th(j-c)I}$	$i = 4$		0,0002	s
<b>Symbol</b>				
$Z_{th(j-c)D}$				
$R_{\theta j-c}$	$i = 1$		75	mk/W
$R_{\theta j-c}$	$i = 2$		38	mk/W
$R_{\theta j-c}$	$i = 3$		10,6	mk/W
$R_{\theta j-c}$	$i = 4$		1,4	mk/W
$\tau_{th(j-c)D}$	$i = 1$		0,0386	s
$\tau_{th(j-c)D}$	$i = 2$		0,0201	s
$\tau_{th(j-c)D}$	$i = 3$		0,001	s
$\tau_{th(j-c)D}$	$i = 4$		0,003	s

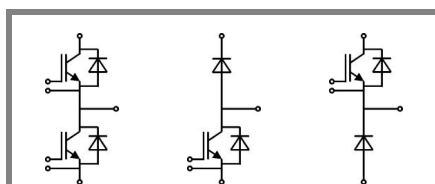

**GB**

**GAL**

**GAR**

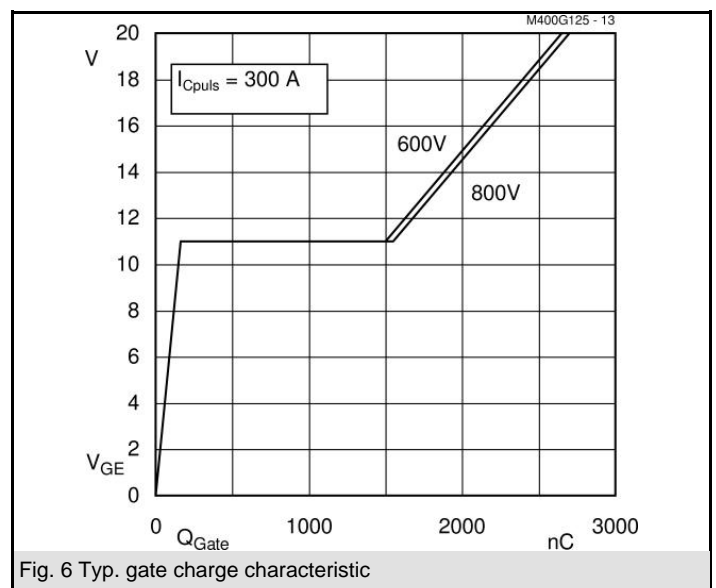
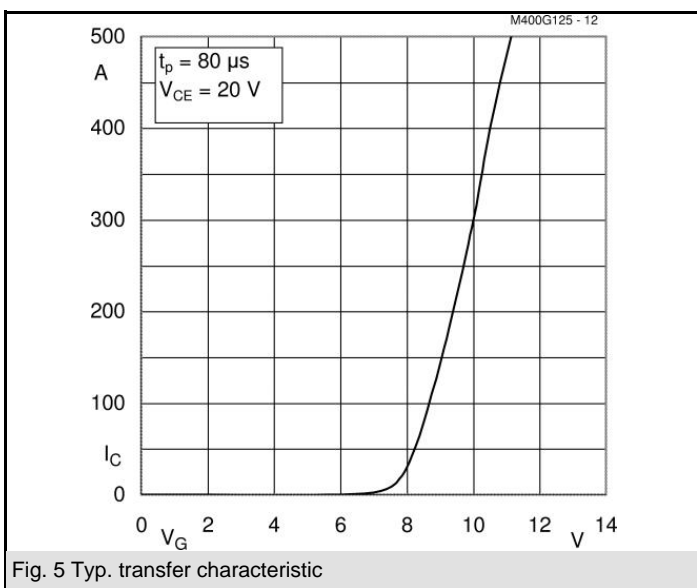
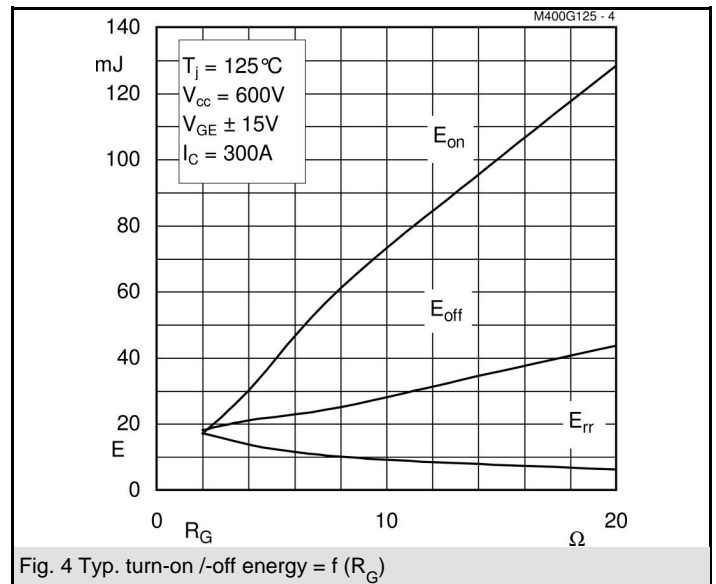
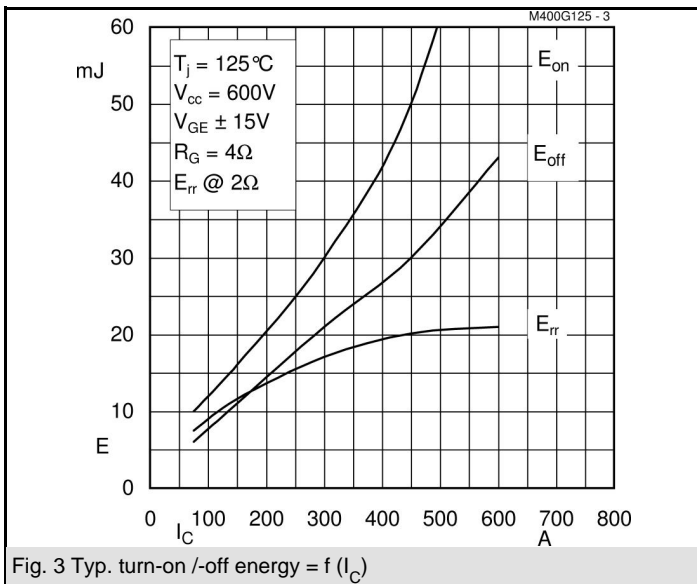
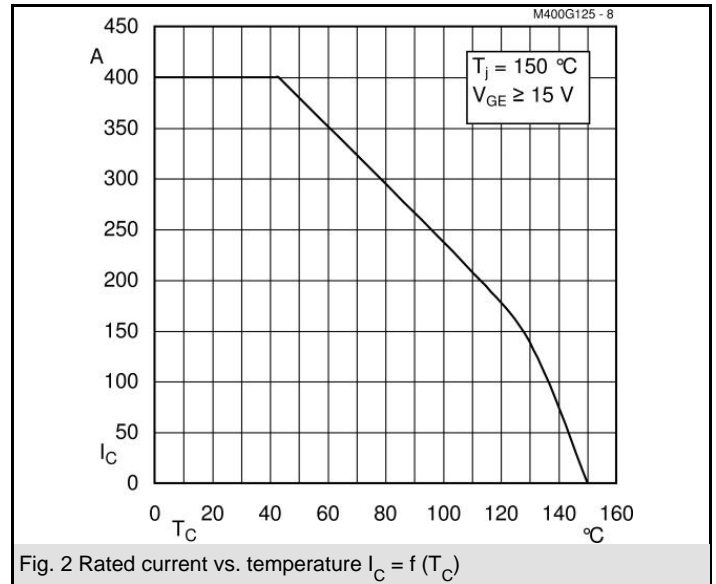
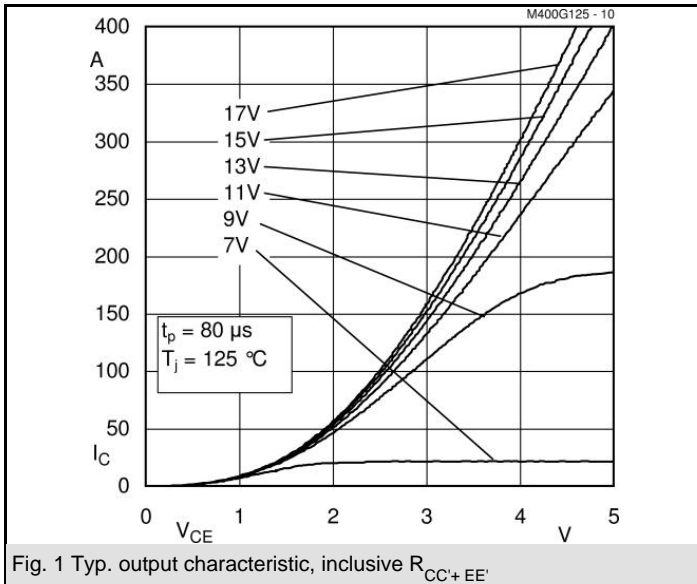

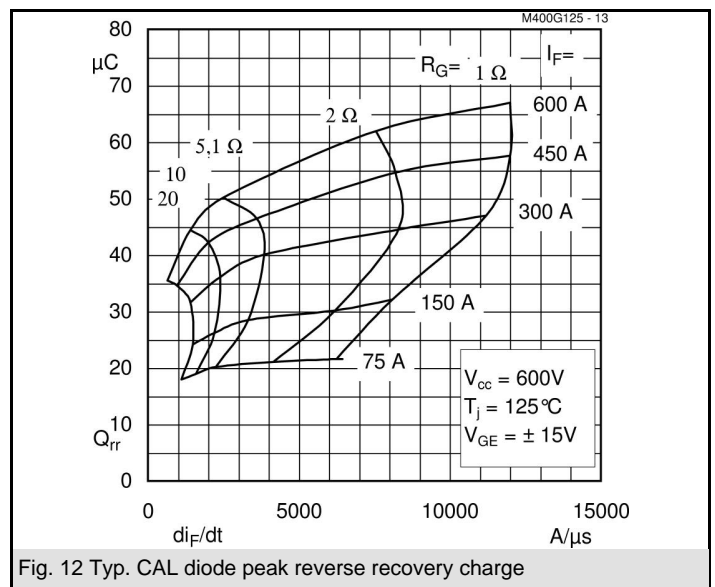
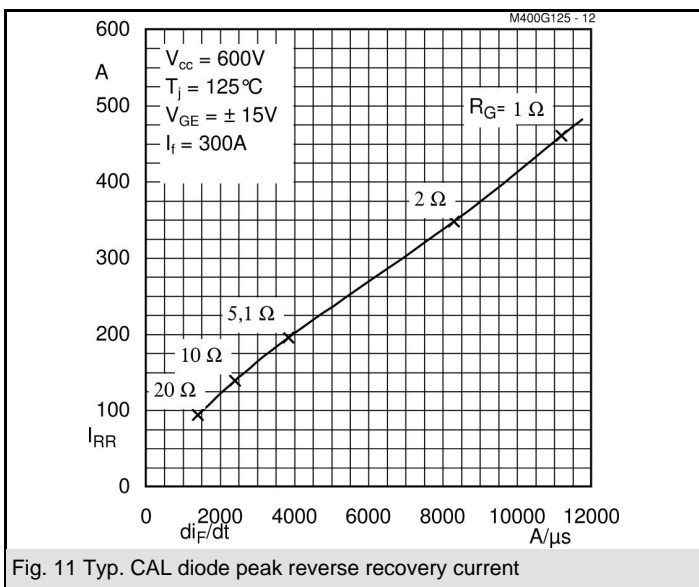
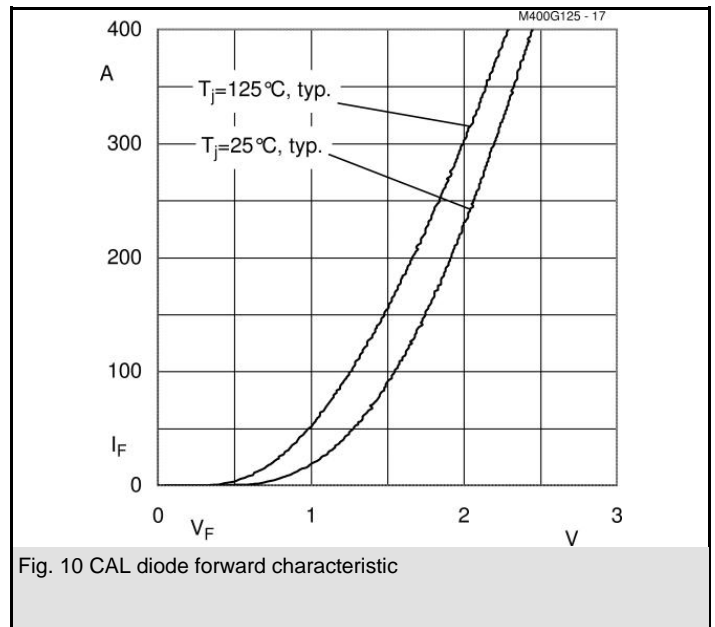
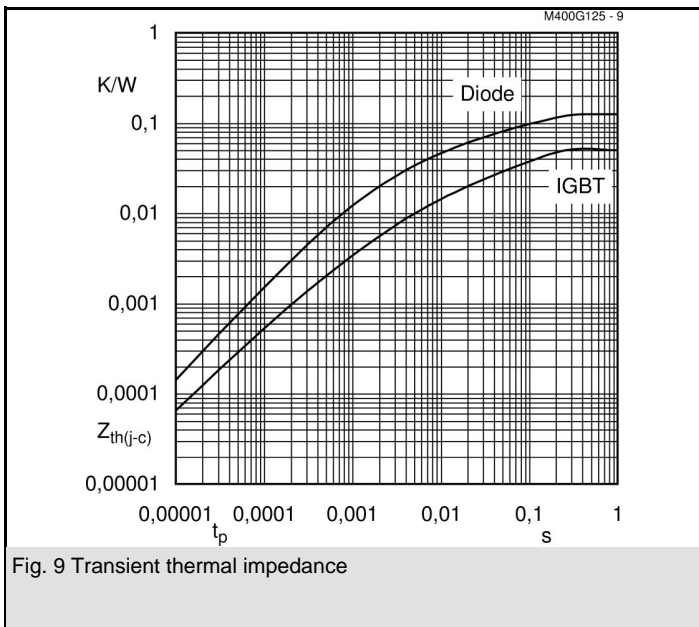
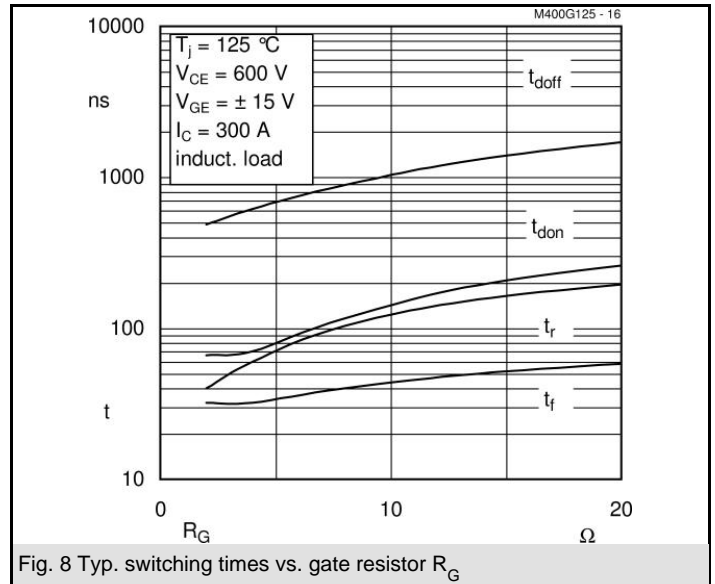
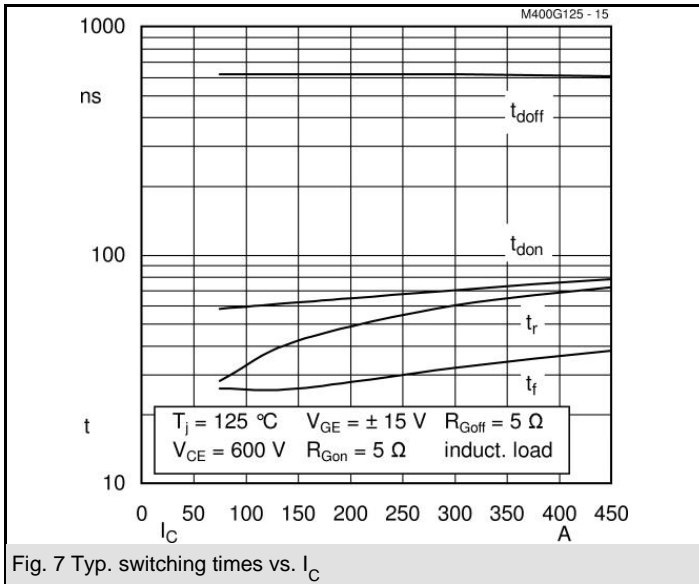

# SKM 400GB125D

UL Recognized

CASED56

File 63 532

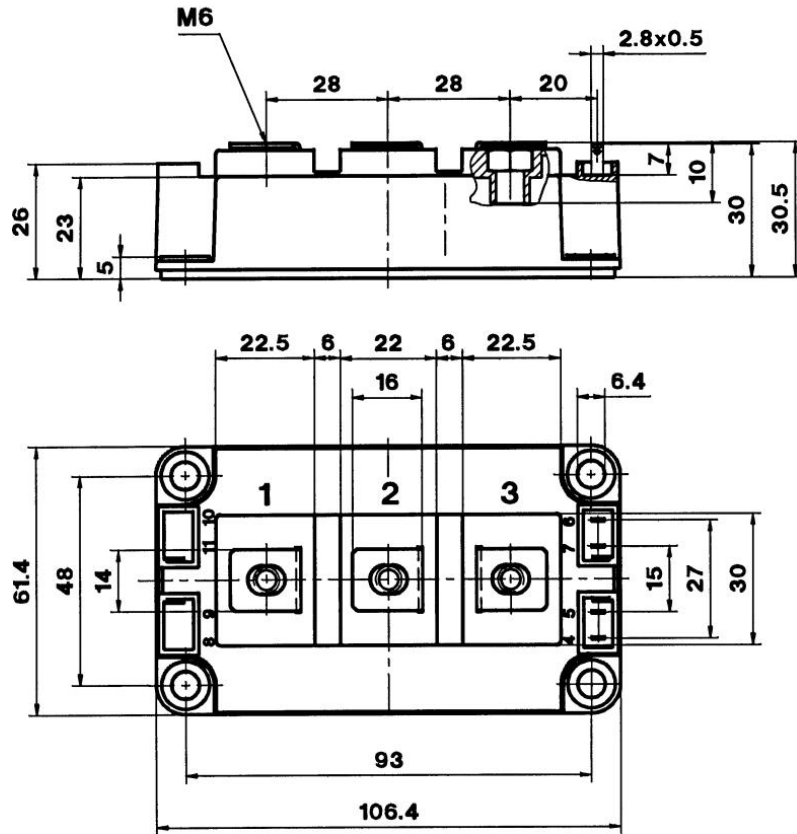

Case D 56

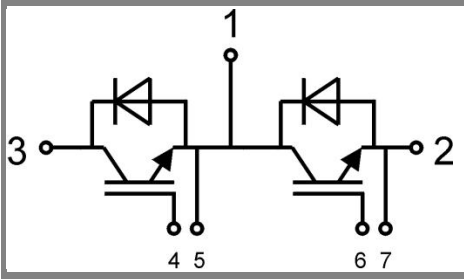

GB Case D 56

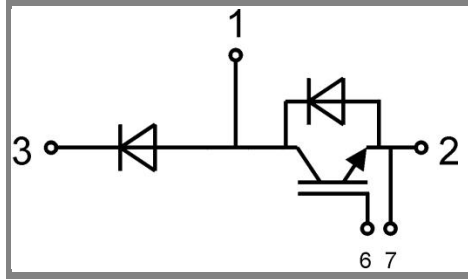

GAL Case D 57 (→ D 56)

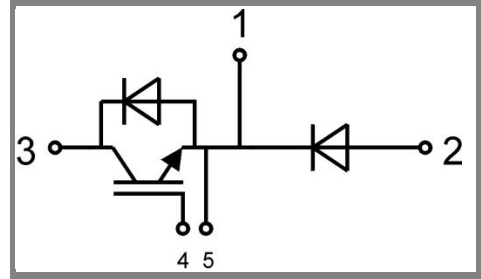

GAR Case D 58 (→ D 56)