



# LDO\_512

## IP Library: Ultra Low Noise, High PSRR, Low Power, 30mA Very Low Dropout Voltage Regulators

PRODUCT PREVIEW

- RF REGULATOR
- VERY LOW DROPOUT VOLTAGE : 30mV
- ULTRA LOW OUTPUT VOLTAGE NOISE
- HIGH PSRR : 70dB
- LOW STAND-BY CURRENT : 20 $\mu$ A
- LOW QUIESCENT CURRENT : 150 $\mu$ A FULL LOAD
- NO CURRENT IN POWER DOWN MODE
- SHORT CIRCUIT PROTECTION
- SMALL DECOUPLING CERAMIC CAPACITOR
- BIPOLAR INPUT STAGE

### TYPICAL APPLICATIONS

- Cellular and Cordless phones supplied by 1 cell Lithium-ion battery / 3 cells Ni-MH or Ni-Cd battery
- PDA (Personal Digital Assistant)
- Smart phone
- Portable equipment
- Supply for RF devices for cellular phone

### APPLICATION NOTE

An external capacitor ( $C_{OUT} = 1\mu\text{F}$ ) with an equivalent serial resistance (ESR) in the range 0.02 to 0.6 $\Omega$  is used for regulator stability.

Figure 1 : Block Diagram

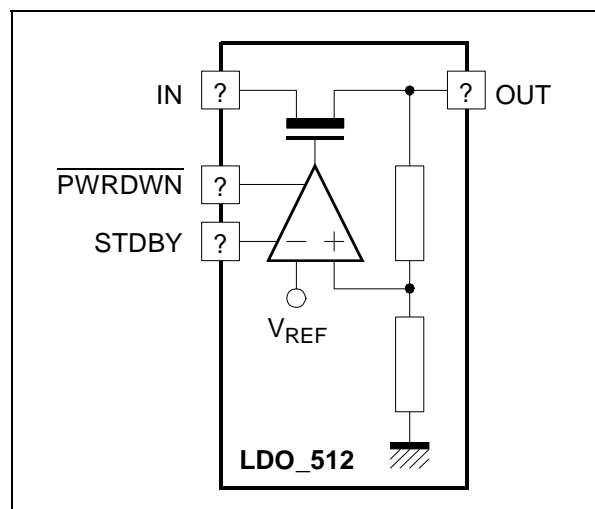
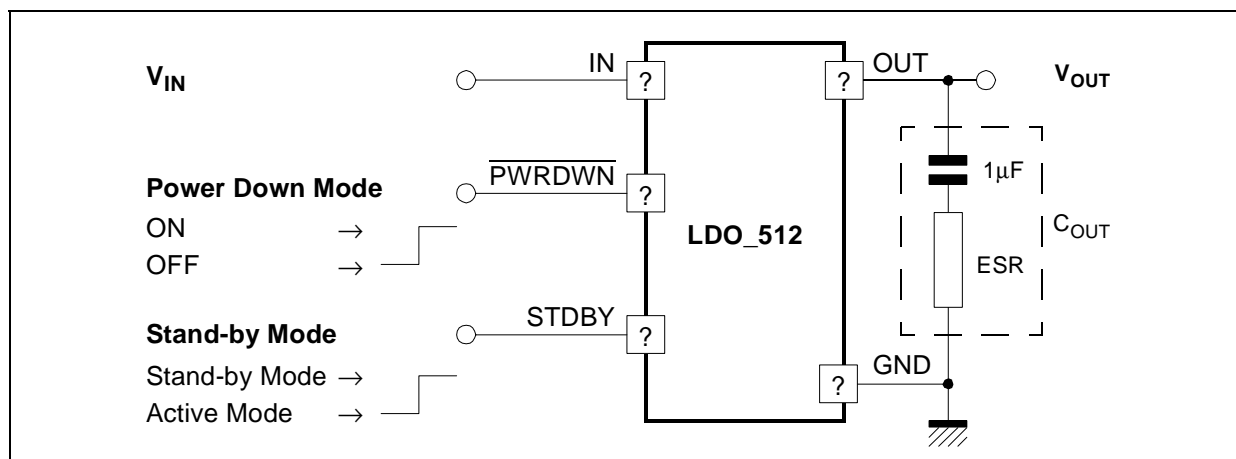

Figure 2 : Typical Application Circuit



**ELECTRICAL CHARACTERISTICS**

$3V < V_{IN} < 5.5V$ ,  $-30^{\circ}C < T_A < +85^{\circ}C$ ,  $V_{REF} = 2.8V$ ,  $0.8\mu F < C_{OUT} < 1.2\mu F$ ,  $20m\Omega < ESR < 0.6\Omega$ ,  
 $100\mu A < I_{LOAD} < 30mA$ .

Typical case :  $V_{IN} = 4V$ ,  $T = 25^{\circ}C$ ,  $I_{OUT} = 15mA$ .

Parameter	Symbol	Test Condition	Min.	Typ.	Max.	Unit
Input Voltage Range (Note 1)	$V_{IN}$		3		5.5	V
Output Voltage	$V_{OUT}$			2.8		V
Output current	$I_{OUT}$				30	mA
PMOS Output Resistance	$R_{ON}$				0.4	$\Omega$
Input Current	$I_{IN}$			200	600	nA
Dropout Voltage	$\Delta V_{DO}$	$I_{LOAD} = 30mA$ , $\Delta V_{OUT} = 50mV$			30	mV
		(Note 2)	170			
Quiescent current	$I_Q$	$I_{LOAD} = 100\mu A$		100	150	$\mu A$
		$I_{LOAD} = 30mA$		150	280	
Stand-by current	$I_{STDBY}$	$I_{LOAD} = 100\mu A$		20	30	$\mu A$
Power down mode quiescent current	$I_{PDN}$	Power down active		0.1		$\mu A$
Power Supply Rejection Ratio	PSRR	$f < 100KHz$	55	70		dB
Power Supply Rejection Ratio in stand-by mode	PSRR <sub>STY</sub>	$f < 100kHz$	60	65		dB
Load Regulation	$L_{DR}$			10	12	mV
Line Regulation	$L_{IR}$	$I_{LOAD} = 30mA$ , $V_{IN} = 3V$ to $5.1V$ , $V_{OUT} = 2.8V$		0.5	1	mV
Line Transient	$L_{IRT}$	$V_{OUT} = 2.8V$ , $I_{OUT} = 30mA$ , $\Delta V_{IN} = 300mV$ $t_{RISE} = t_{FALL} = 10\mu s$		0.5	1.5	mV
Load Transient	$L_{DTR}$	$V_{OUT} = 2.8V$ , $t_{RISE} = t_{FALL} = 10\mu s$ $100\mu A < I_{LOAD} < 30mA$			3	mV
		Recovery time		10	20	
Output Voltage Noise	en	$100Hz < f \leq 1KHz$		30	70	$\frac{nV}{\sqrt{Hz}}$
		$1KHz < f \leq 100KHz$		20	35	
		$f > 100KHz$		20	30	
Output Decoupling Capacitor	$C_{OUT}$			1		$\mu F$
Settling Time (from power down to active mode)		$V_{OUT} = 2.8V$ , $C_{OUT} = 1\mu F$		20	50	$\mu s$
Short Circuit Current Limit	$I_{SHORT}$				200	mA

Notes: 1. Above characteristics are given for 3V minimum input operating range voltage, but regulator is operational with 2.7V minimum input voltage.

2. All parameters are guaranteed with 170mV Dropout voltage.

**TYPICAL CHARACTERISTICS**

**Figure 3 : PSRR vs Frequency**  
(Iload max - Vin min)

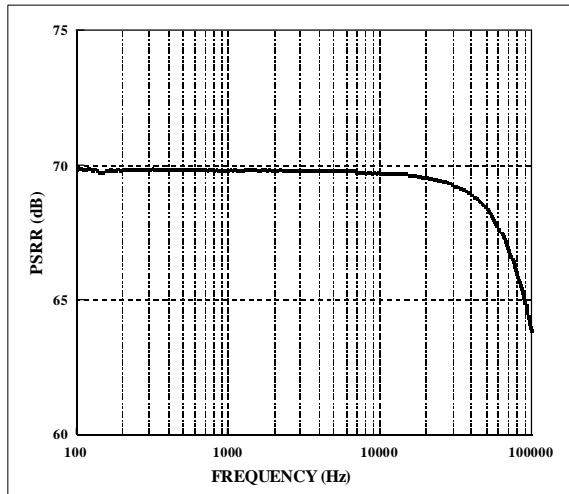

**Figure 4 : Noise vs Frequency**  
(Iload max - Vin min)

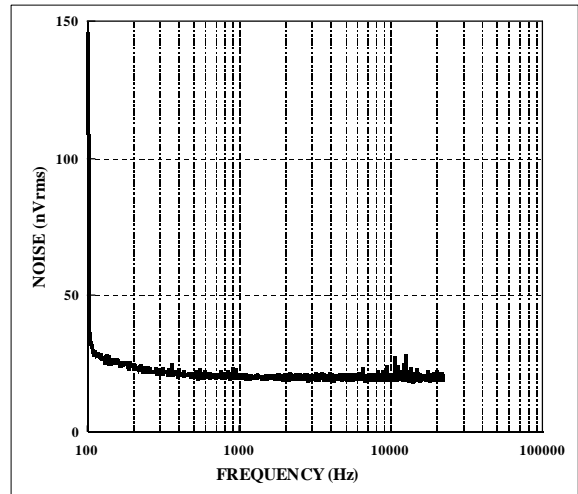

**Figure 5 : Load Transient (rising edge)**

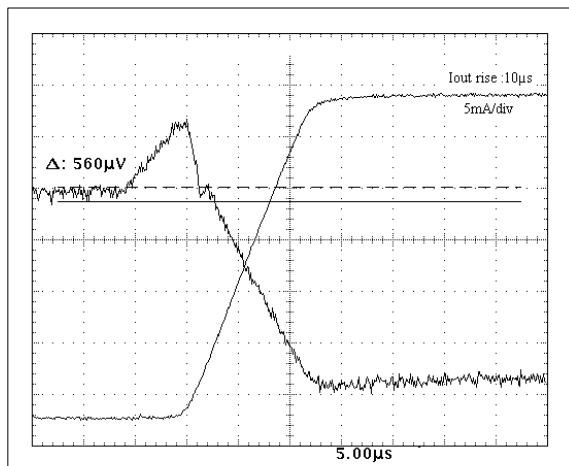

**Figure 6 : Load Transient (falling edge)**

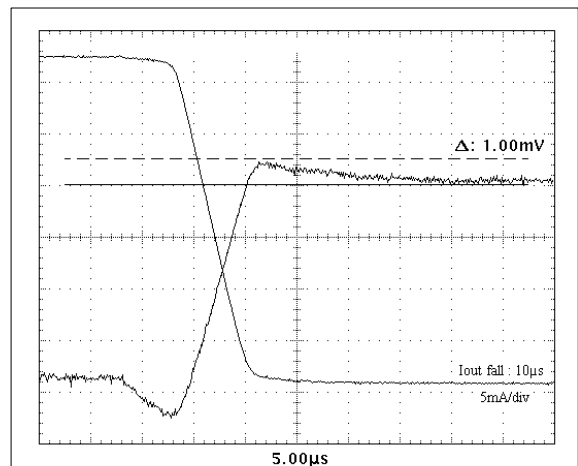

**Figure 7 : Load Transient in Std-by mode**  
(rising edge)

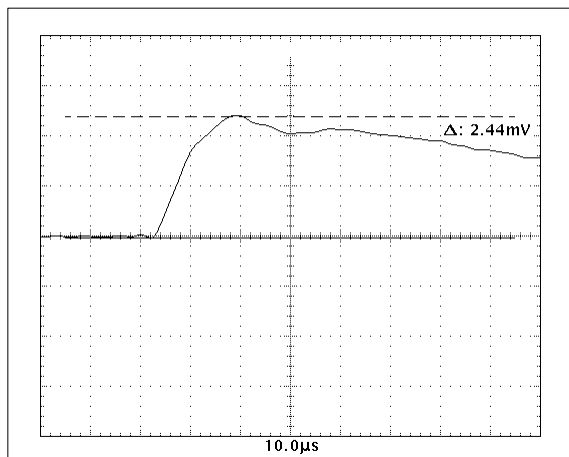

**Figure 8 : Load Transient in Std-by mode**  
(falling edge)

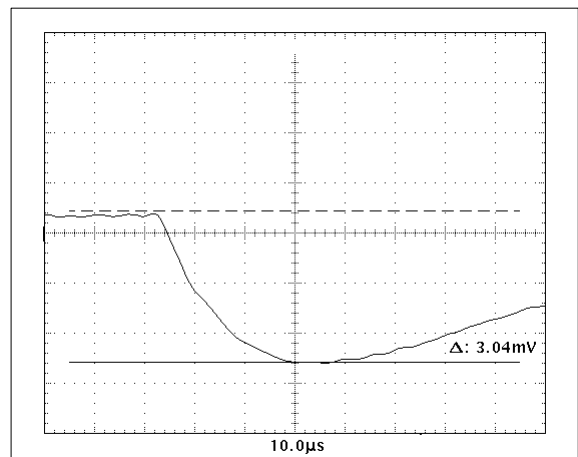

**Figure 9 : Output Voltage vs Input Voltage (Line Regulation)**

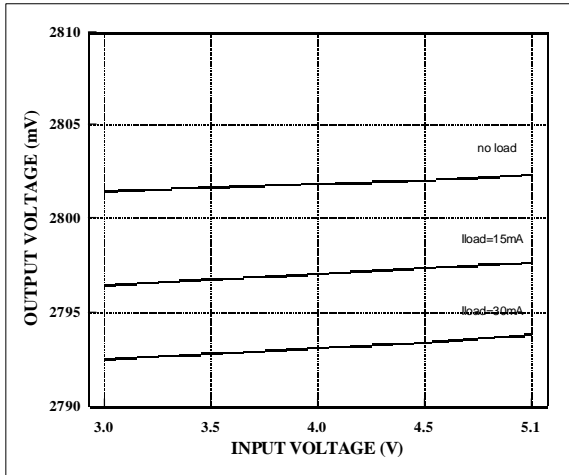

**Figure 10 : Output Voltage vs Input Voltage (Line Regulation - Stand-by mode)**

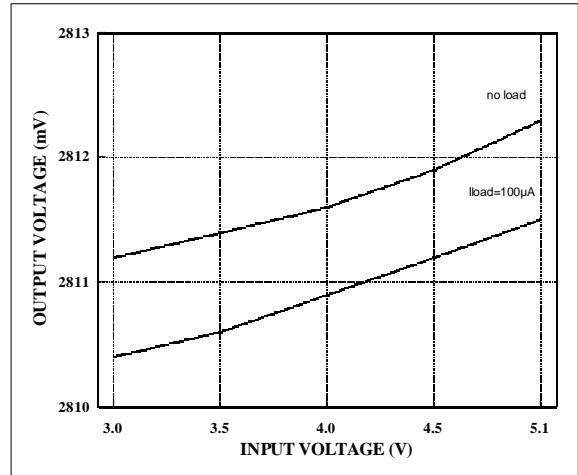

**Figure 11 : Line Transient (rising edge ; Vin min ; Iload max)**

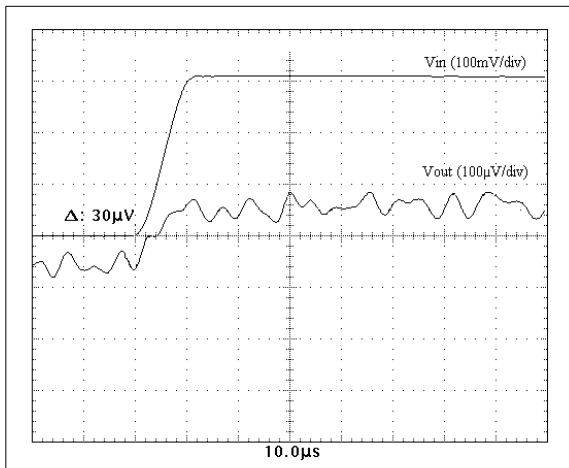

**Figure 12 : Line Transient (falling edge ; Vin min ; Iload max)**

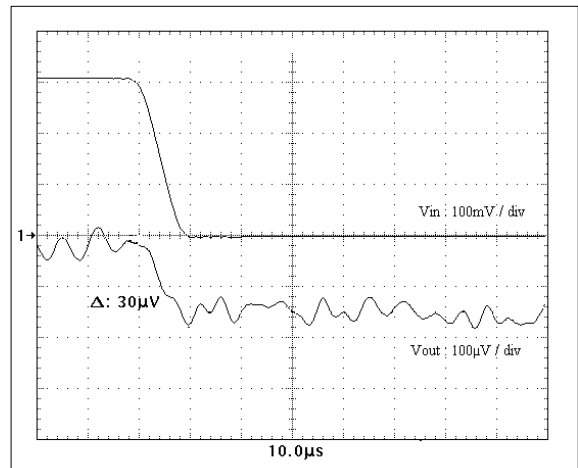

**Figure 13 : Output Voltage vs Output Current (Load Regulation)**

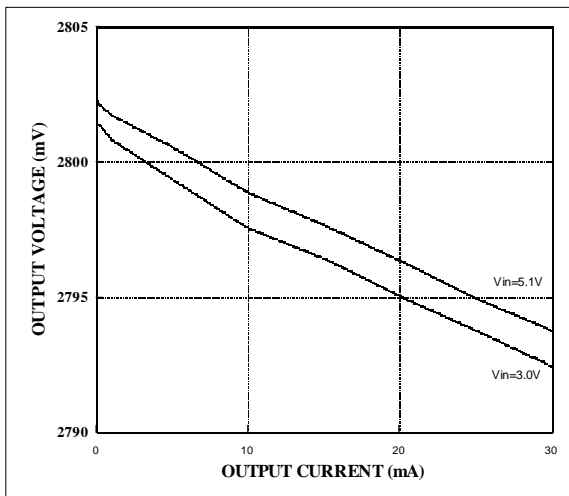

**Figure 14 : Output Voltage vs Output Current (Load Regulation - Stand-by mode)**

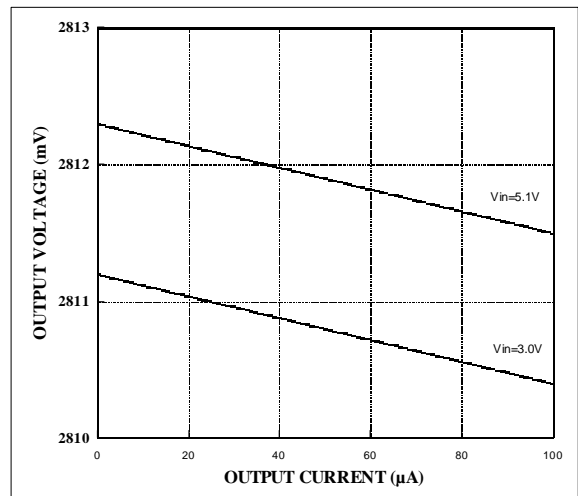

Information furnished is believed to be accurate and reliable. However, STMicroelectronics assumes no responsibility for the consequences of use of such information nor for any infringement of patents or other rights of third parties which may result from its use. No license is granted by implication or otherwise under any patent or patent rights of STMicroelectronics. Specifications mentioned in this publication are subject to change without notice. This publication supersedes and replaces all information previously supplied. STMicroelectronics products are not authorized for use as critical components in life support devices or systems without express written approval of STMicroelectronics.

The ST logo is a registered trademark of STMicroelectronics

© 2002 STMicroelectronics - All Rights Reserved

STMicroelectronics GROUP OF COMPANIES

Australia - Brazil - Canada - China - Finland - France - Germany - Hong Kong - India - Israel - Italy - Japan - Malaysia - Malta - Morocco  
Singapore - Spain - Sweden - Switzerland - United Kingdom - United States

<http://www.st.com>