

MMBD2835, MMBD2836

Dual Switching Diodes

Features

- Small package
- Low forward voltage
- Fast reverse recovery time
- Small total capacitance

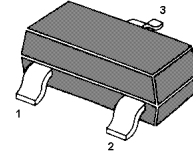
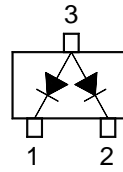

Marking Code: **A1**
SOT-23 Plastic Package

Applications

- Ultra high speed switching application

Absolute Maximum Ratings ($T_a = 25\text{ }^\circ\text{C}$)

Parameter	Symbol	Value	Unit
Reverse Voltage	V_R	35 75	V
Forward Current	I_F	100	mA
Power Dissipation	P_d	300	mW
Junction Temperature	T_j	150	$^\circ\text{C}$
Storage Temperature Range	T_s	- 55 to + 150	$^\circ\text{C}$

Characteristics at $T_a = 25\text{ }^\circ\text{C}$

Parameter	Symbol	Min.	Max.	Unit
Forward Voltage at $I_F = 10\text{ mA}$	V_F	-	1	V
at $I_F = 50\text{ mA}$	V_F	-	1	V
at $I_F = 100\text{ mA}$	V_F	-	1.2	V
Reverse Current at $V_R = 30\text{ V}$	I_R	-	100	nA
at $V_R = 50\text{ V}$	I_R	-	100	nA
Reverse Breakdown Voltage at $I_R = 100\text{ }\mu\text{A}$	$V_{(BR)R}$	35 75	- -	V
Diode Capacitance at $f = 1\text{ MHz}$	C_T	-	4	pF
Reverse Recovery Time at $I_F = I_R = 10\text{ mA}$, $I_{R(REC)} = 1\text{ mA}$	t_{rr}	-	4	ns

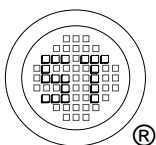

SEMTECH ELECTRONICS LTD.

(Subsidiary of Sino-Tech International Holdings Limited, a company
listed on the Hong Kong Stock Exchange, Stock Code: 724)



ISO/TS 16949 : 2002 Certificate No. 05103
ISO 14001:2004 Certificate No. 7116
ISO 9001:2000 Certificate No. 0506098

Dated : 10/10/2008

MMBD2835, MMBD2836

FIGURE 1. RECOVERY TIME EQUIVALENT TEST CIRCUIT

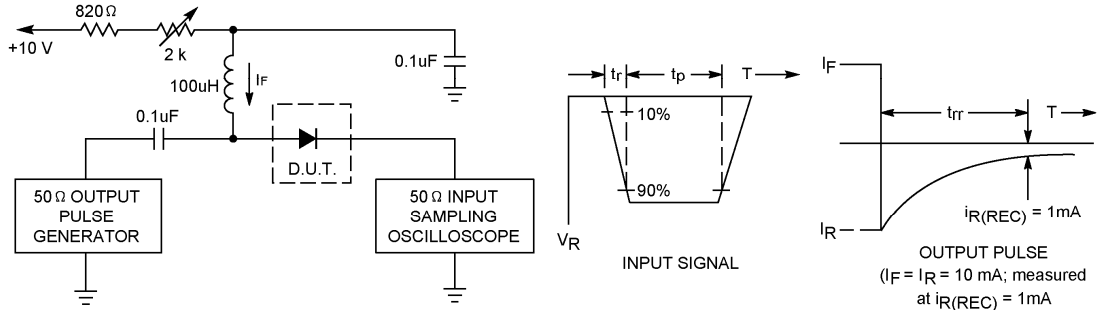

- Notes: 1. A 2.0kΩ variable resistor adjusted for a Forward Current (I_F) of 10mA.
 2. Input pulse is adjusted so $I_{R(\text{peak})}$ is equal to 10mA.
 3. $t_p \gg t_{rr}$

FIGURE 2. FORWARD VOLTAGE

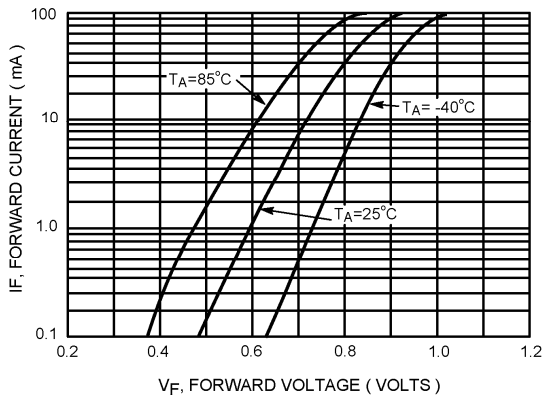

FIGURE 3. LEAKAGE CURRENT

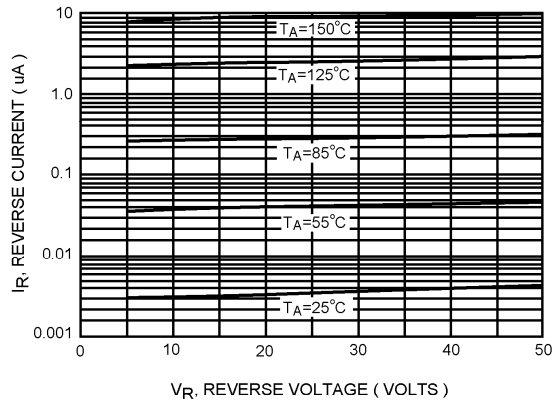
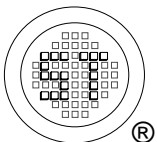
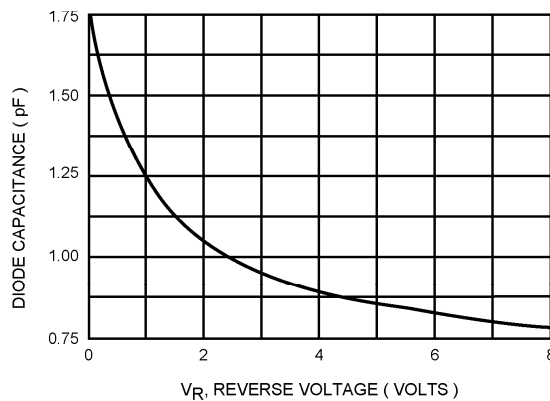

FIGURE 4. CAPACITANCE



SEMTECH ELECTRONICS LTD.
 (Subsidiary of Sino-Tech International Holdings Limited, a company listed on the Hong Kong Stock Exchange, Stock Code: 724)



ISO/TS 16949:2002 Certificate No. 05103
 ISO 14001:2004 Certificate No. 7116
 ISO 9001:2000 Certificate No. 0506098

Dated : 10/10/2008