

SPECIFICATION FOR APPROVAL

REF : 20090324-B

PAGE: 1

PROD. NAME	SMD LINE FILTER	ABC'S DWG NO. ABC'S ITEM NO.	SF2012□□□□L□-□□□
---------------	-----------------	---------------------------------	------------------

I . MECHANICAL DIMENSIONS :

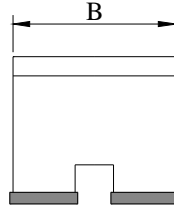
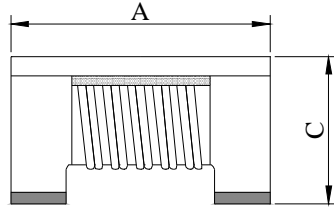

- A : 2.05±0.2 m/m
- B : 1.25±0.2 m/m
- C : 1.25±0.2 m/m
- D : 0.40 typ. m/m
- E : 0.45 typ. m/m
- F : 0.80 ref. m/m
- G : 0.90 ref. m/m
- H : 0.50 ref. m/m
- I : 0.35 ref. m/m

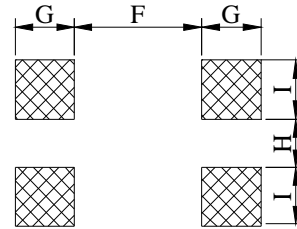
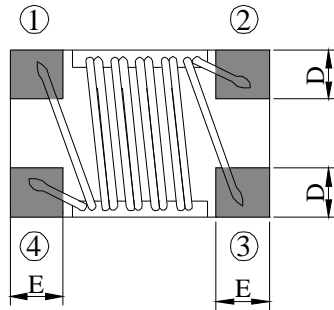

(PCB Pattern)

II . SCHEMATIC DIAGRAM :

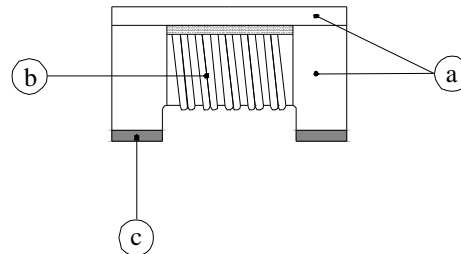
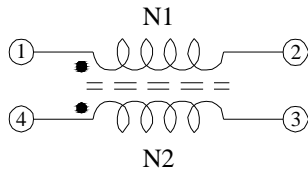

III . MATERIALS LIST :

- a . Core : Ferrite
- b . Wire : Enamelled copper wire (class F)
- c . Terminal : Ag / Ni / Sn
- d . Remark : Products comply with RoHS' requirements

Peak Temp : 260°C max.
 Max time above 230°C : 50sec max.
 Max time above 200°C : 70sec max.

IV . GENERAL SPECIFICATION :

- a . Temp rise : 20°C max
- b . Rated current : Base on temp. rise
& ΔL/L0A=20% max.
- c . Storage temp. : -55°C ----+125°C
- d . Operating temp. : -55°C ----+125°C
(Temp. rise included)

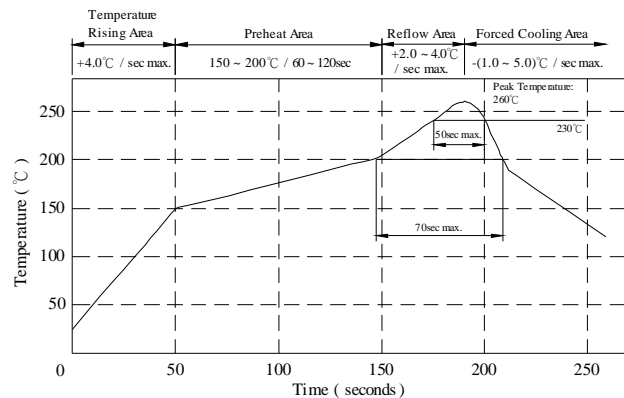

AR-001A

SPECIFICATION FOR APPROVAL

REF : 20090324-B

PAGE: 2

PROD.	SMD LINE FILTER	ABC'S DWG NO.	SF2012□□□□L□-□□□
NAME		ABC'S ITEM NO.	

V . ELECTRICAL CHARACTERISTICS :

Dwg. No.	Impedance (Ω) @ 100 MHz	Rated (DC) V	Withstanding (DC) V	Insulation Resistance (MΩ) min.	RDC (Ω) max.	IDC (mA) max.
SF2012300YL□-□□□	30±25%	50	125	10	0.200	450
SF2012670YL□-□□□	67±25%	50	125	10	0.250	400
SF2012900YL□-□□□	90±25%	50	125	10	0.350	330
SF2012121YL□-□□□	120±25%	50	125	10	0.300	370
SF2012161YL□-□□□	160±25%	50	125	10	0.400	300
SF2012181YL□-□□□	180±25%	50	125	10	0.350	330
SF2012201YL□-□□□	200±25%	50	125	10	0.350	330
SF2012221YL□-□□□	220±25%	50	125	10	0.350	310
SF2012261YL□-□□□	260±25%	50	125	10	0.400	300
SF2012301YL□-□□□	300±25%	50	125	10	0.400	290
SF2012361YL□-□□□	360±25%	50	125	10	0.450	280
SF2012371YL□-□□□	370±25%	50	125	10	0.450	280
SF2012501YL□-□□□	500±25%	50	125	10	0.550	170
SF2012671YL□-□□□	670±25%	50	125	10	0.600	140
SF2012901YL□-□□□	900±25%	50	125	10	0.600	80

- 1). □ : Packaging information... A : Bulk B : Taping Reel
- 2). "-□□□":Reference code
- 3). Impedance Test Instrument : HP4291A
- 4). RDC Test Instrument : CH-502AC
- 5). IDC Test Instrument : CH1062+CH301A

AR-001A



SPECIFICATION FOR APPROVAL

PROD. NAME	SMD LINE FILTER	ABC'S DWG NO.	SF2012□□□□L□-□□□
		ABC'S ITEM NO.	

VI . INSERTION LOSS Vs. FREQUENCY & IMPEDANCE Vs. FREQUENCY :

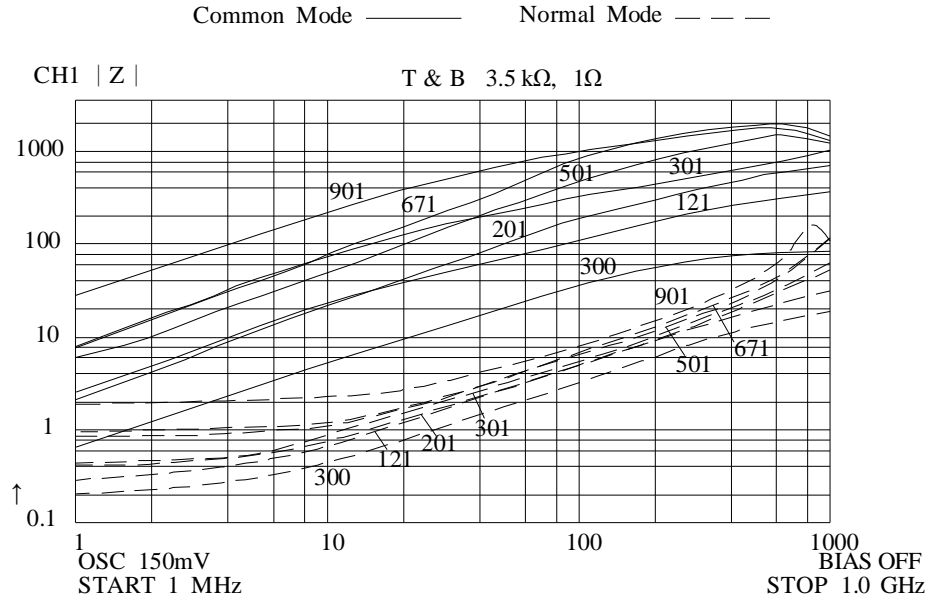

Z (Ω)	Common Mode							Normal Mode						
	1 MHz	3 MHz	10 MHz	30 MHz	100 MHz	300 MHz	1 GHz	1 MHz	3 MHz	10 MHz	30 MHz	100 MHz	300 MHz	1 GHz
300	0.64	1.94	5.99	14.34	31.33	53.67	93.89	0.200	0.240	0.470	1.180	3.490	9.850	34.370
670	1.45	4.42	13.62	32.45	70.17	117.65	201.20	0.250	0.290	0.550	1.340	3.830	10.560	34.260
900	1.04	3.09	10.14	28.96	90.46	253.50	491.35	0.280	0.330	0.610	1.520	4.150	11.260	38.760
121	2.64	7.96	23.80	56.67	126.11	218.67	417.23	0.330	0.380	0.670	1.640	4.710	13.030	43.460
161	1.79	5.35	17.50	49.70	153.36	327.38	574.77	0.390	0.440	0.760	1.850	5.290	14.560	53.660
181	3.87	11.68	35.09	82.74	180.25	314.98	587.53	0.400	0.450	0.750	1.800	5.050	13.770	48.810
201	2.13	6.23	21.05	62.77	195.72	389.82	692.15	0.310	0.370	0.750	1.820	5.100	15.240	52.450
221	6.01	18.95	58.21	142.32	228.47	357.32	689.21	0.520	0.540	0.820	1.910	4.010	10.450	50.120
261	5.33	15.85	46.54	109.83	263.01	479.42	895.05	0.450	0.500	0.850	2.040	5.770	15.820	62.080
301	8.18	24.92	75.83	176.72	312.67	518.25	935.14	0.440	0.480	0.830	2.100	5.760	16.570	62.340
361	4.12	10.42	40.12	115.25	394.62	709.21	1121.20	0.510	0.590	0.910	2.120	5.920	17.280	75.120
371	4.16	12.42	40.38	113.88	369.14	802.72	1135.60	0.510	0.560	0.890	2.070	5.760	15.600	72.730
501	6.01	17.11	50.84	159.41	526.13	1108.41	1203.79	0.850	0.910	1.200	2.450	6.980	18.240	112.540
671	7.98	22.36	72.49	208.63	771.21	1687.25	1523.14	0.980	1.120	1.480	2.780	7.120	19.870	145.680
901	28.67	80.12	220.31	208.21	990.21	1654.21	1354.21	1.980	1.150	1.150	3.450	8.540	22.540	115.250

SPECIFICATION FOR APPROVAL

REF : 20090324-B

PAGE: 4

PROD. NAME	SMD LINE FILTER	ABC'S DWG NO.	SF2012□□□□L□-□□□
		ABC'S ITEM NO.	

VII . ELECTRICAL CHARACTERISTICS :

(1) Configuration

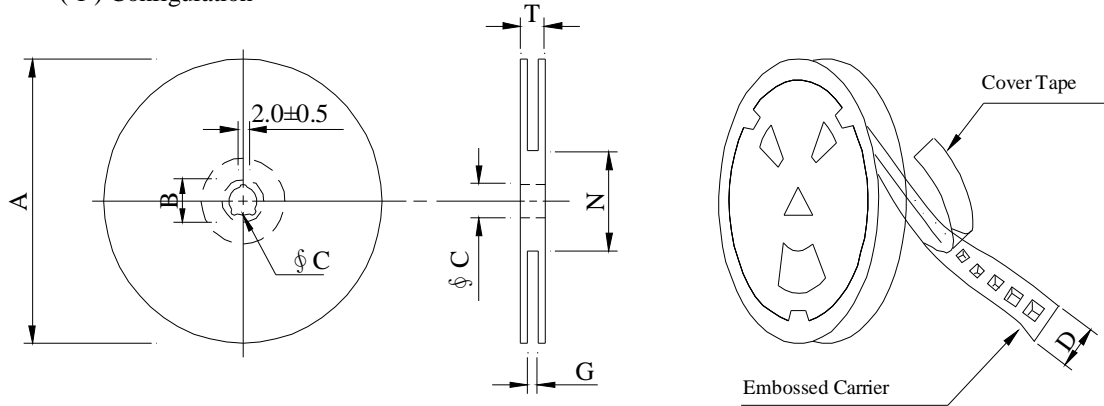

※Carrier Tape Width : D

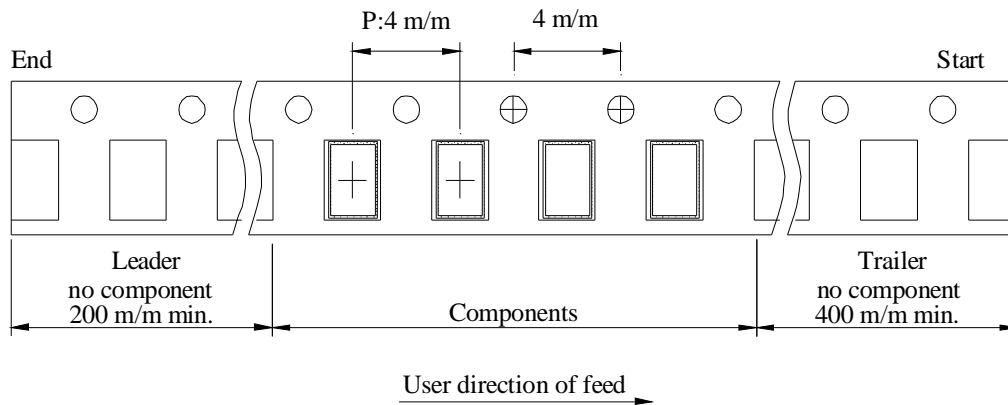

(2) Dimensions

Unit:m/m

Style	A	B	C	D	G	N	T
07 - 08	178	21±0.8	13	8	14 ⁺⁰	50 ⁻⁰	16.5

(3) Q'TY & G.W. Per package

Series	Inner : Reel			Outer : Carton		
	Q'TY (pcs)	G.W. (gw)	Style	Q'TY (pcs)	G.W. (Kg)	SIZE (cm)
SF2012	2,000	95	07 - 08	100,000	6.50	41 x 39 x 22

AR-001A

SPECIFICATION FOR APPROVAL

REF : 20090324-B

PAGE: 5

PROD. NAME	SMD LINE FILTER	ABC'S DWG NO.	SF2012□□□□L□-□□□
		ABC'S ITEM NO.	

VIII . DWGING NUMBER EXPRESSION :

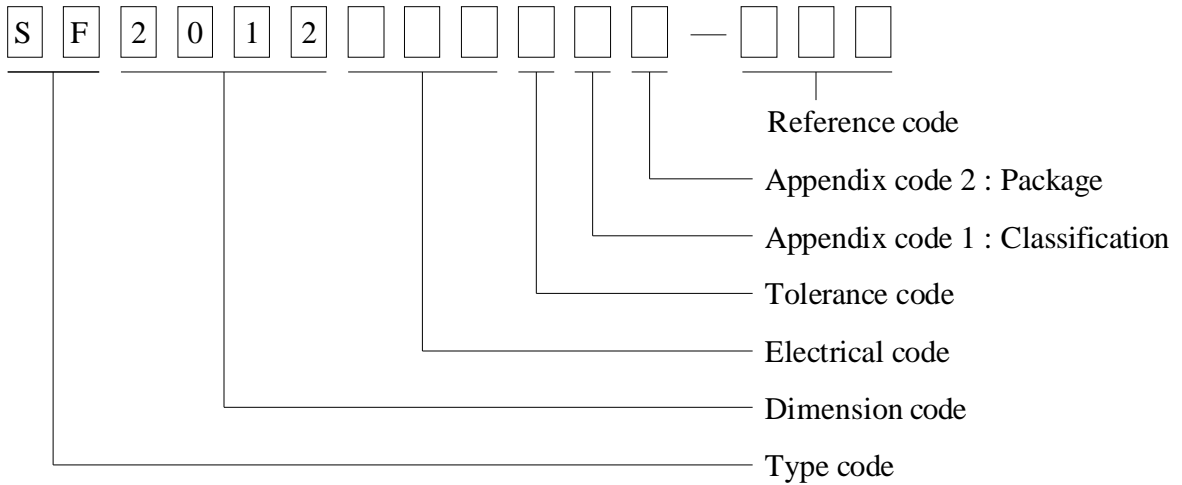

Appendix code 1 : Product Classification

- L : Lead Free Standard products comply with RoHS' requirements
- 1 ~ 9 : Lead Free Special products comply with RoHS' requirements

Appendix code 2 : Package Information

Code	Inner package	Inner package Q'TY	Remark
A	T.B.D.	T.B.D.	
B	T / R (Reel package)	2000 pcs	

SPECIFICATION FOR APPROVAL

REF : 20090324-B

PAGE: 6

PROD. NAME	SMD LINE FILTER	ABC'S DWG NO.	SF2012□□□□L□-□□□
		ABC'S ITEM NO.	

IX . RELIABILITY TEST :

1-1.Environmental Performance

No	Item	Specification	Test Method															
1-1-1	Temperature Cycle	Appearance: No Damage Impedance: within±20% of initial value	One cycle: <table border="1" style="width: 100%; border-collapse: collapse;"> <thead> <tr> <th>Step</th> <th>Temperature (°C)</th> <th>Time (min)</th> </tr> </thead> <tbody> <tr> <td>1</td> <td>-25±3</td> <td>30</td> </tr> <tr> <td>2</td> <td>25±2</td> <td>3</td> </tr> <tr> <td>3</td> <td>85±3</td> <td>30</td> </tr> <tr> <td>4</td> <td>25±2</td> <td>3</td> </tr> </tbody> </table> Total: 5 cycles Measured After Exposure in The Room Condition For 1hrs	Step	Temperature (°C)	Time (min)	1	-25±3	30	2	25±2	3	3	85±3	30	4	25±2	3
Step	Temperature (°C)	Time (min)																
1	-25±3	30																
2	25±2	3																
3	85±3	30																
4	25±2	3																
1-1-2	Humidity Resistance		Temperature: 40±2°C Relative Humidity: 90 ~ 95% Time: 100hrs Measured After Exposure In The Room Condition For 1hrs															
1-1-3	High Temperature Resistance		Temperature: 85±3°C Time: 50Hrs Measured After Exposure In The Room Condition For 1Hrs															
1-1-4	Low Temperature Resistance		Temperature: -25±3°C Time: 50Hrs Measured After Exposure In The Room Condition For 1Hrs															
1-1-5	High Temperature Load Life	There should be no evidence of short or open circle	Temperature: 85±3°C Load: Allowed DC Current Time: 500Hrs															
1-1-6	Humidity Load Life		Temperature: 40±2°C Relative Humidity: 90~95% Load: Allowed DC Current Time: 500Hrs															

1-2.Mechanical Performance

No	Item	Specification	Test Method
1-2-1	Resistance To Soldering Heat	Appearance: No Damage	1. The Device Should Be Reflow soldered on PCB (peak 260°C±5°C For 10 Seconds) 2. Solder Composition: Sn/Ag3.0/Cu0.5 3. Test Time: 6 minutes
1-2-2	Solder ability	The Electrodes Shall Be At Least 90% Covered with New Solder Coating	1. Pre-Heating: 150°C, 1min. 2. Solder Composition: Sn/Ag3.0/Cu0.5 3. Solder Temperature: 245±5°C. 4. Immersion Time: 4±1 sec.
1-2-3	Componment Adhesion (Push Test)	2 Lbs	The device should be reflow soldered (230±5°C For 10 seconds) to a tinned copper substrate. A force guauge should be applied to the side of the component. The device must withstand a minimum force of 2 pounds without a failure of the termination attached to component

AR-001A



SPECIFICATION FOR APPROVAL

REF : 20090324-B

PAGE: 7

PROD. NAME	SMD LINE FILTER	ABC'S DWG NO. ABC'S ITEM NO.	SF2012□□□□L□-□□□
---------------	-----------------	---------------------------------	------------------

X . UL CARD :

OBMW2 September 8, 2000

Magnet Wire-Component

JUNG SHING WIRE CO LTD E174837

231 CHUNG CHENG RD, SEC 3 JEN-TEH HSIANG, TAINAN
HSIEN TAIWAN

Mtl Dsg	Mark Dsg	BC	Coat Typ	OC	ANSI Type	Temp Class
AIW	---	Polyamideimide	---	---	MW81-C	220
CFUEWB	---	Polyurethane	---	---	MW75C	130
EIAIW	---	Polyesterimide	Polyamideimide	---	MW35C	200
EILOCKY	---	Polyesterimide	Polyamide	---	---	180
EILOCKW	---	Polyesterimide	Modified Epoxy	---	---	200
EIW	---	Polyesterimide	---	---	---	220
EIW-2	---	Polyesterimide	---	---	MW74-C	200
FL.EILOCKY	---	Modified Polyester	Polyamide	---	---	155
LSFFW	---	Polyurethane	---	---	MW79-C	155
LSUEW	---	Polyurethane	---	---	---	130
PEW	---	Polyester	---	---	---	155
PEY	---	Polyester	Nylon	---	MW24-C	155
SF.FLW	---	Modified Polyester	---	---	MW26C	155
SF.EIW	---	Polyesterimide	---	---	MW77C	180
SF.BY@	---	Modified Polyester	Nylon	---	MW27-C	155
SF.FLY@	---	Modified Polyester	Nylon	---	MW27-C	155
SF.BLOCKBS	---	Modified Polyester	Modified Polyamide	---	---	155
SF.EILOCKY#	---	Polyesterimide	Polyamide	---	---	180
SF.EILOCKBS	---	Polyesterimide	Modified Polyamide	---	---	180
SF.BW@	---	Modified Polyester	---	---	MW26C	155
SFFW	---	Polyurethane	---	---	MW79	155

287806002 Page 1 of 2

A not-for-profit organization dedicated to public safety and committed to quality service

Mtl Dsg	Mark Dsg	BC	Coat Typ	OC	ANSI Type	Temp Class
SFFY	---	Polyurethane	Polyamide	---	MW80C	155
UEW-1	---	Polyurethane	---	---	MW2-C	105
UEW-2	---	Polyurethane	---	---	---	130
UEW-4	---	Polyurethane	---	---	MW75C	130
UEY	---	Polyurethane	Nylon	---	MW28-C	130
UEY-2	---	Polyurethane	Polyamide	---	MW28-C	130

@ - May be suffixed by LZ; # - May be suffixed by LZ, EL or LZI.
LZ - Signifies magned wires twisted together; EL - signifies base coated magnet wire laid parallel with top coat applied overall; LZL - signifies base coated magnet wire twisted together and covered with top coat overall.

Marking: Company name or trademarks JSW or 榮星電線 , material designation or marked designation on packaed or reel, and Recognized Component Mark.

See General Information Preceding These Recognitions
For use only in equipment where the acceptability of the combination is determined by Underwriters Laboratories Inc.

287806002 Page 2 of 2

OBMW2/E174837
September 8, 2000

AR-001A

