

Metallized Polypropylene Film Capacitors DC Capacitor MKP Type

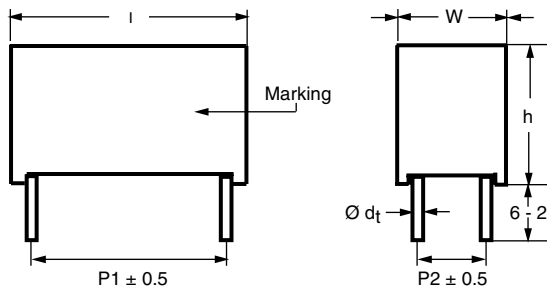
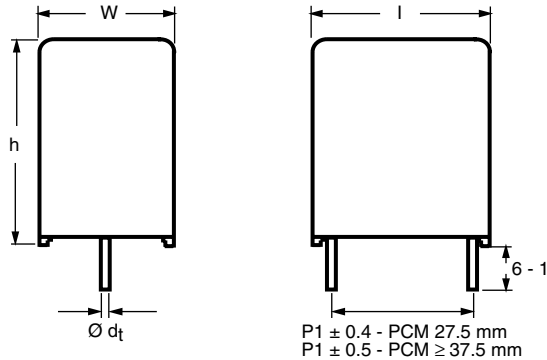

Dimensions in millimeters
 $\varnothing d_t \pm 10\%$ of standard diameter specified

APPLICATIONS

High performance DC filtering applications

REFERENCE STANDARDS

IEC 61071
 IEC 60068

MARKING

C-value; tolerance; rated voltage; code for dielectric material; code for manufacturing origin; manufacturer's type designation; manufacturer's logo; year and week of manufacture

DIELECTRIC

Polypropylene film

ELECTRODES

Metallized dielectric capacitor

CONSTRUCTION

Mono construction

ENCAPSULATION

Plastic case, sealed with resin
 Flame retardant

TERMINALS

Tinned wires

FEATURES

Lead (Pb)-free product
 RoHS compliant product



RATED CAPACITANCE

1 μ F to 400 μ F



CAPACITANCE TOLERANCE

$\pm 5\%$

RoHS
 COMPLIANT

DC VOLTAGE RATING

85 °C	450 V	700 V	900 V	1100 V	1200 V
70 °C	500 V	800 V	1100 V	1350 V	1500 V
105 °C	300 V	500 V	650 V	800 V	850 V

INSULATION RESISTANCE

RC between leads, after 1 min > 10 000 s
 For $U_{Ndc} \leq 500$ V measuring voltage 100 V
 For $U_{Ndc} > 500$ V measuring voltage 500 V

SELF INDUCTANCE (L_s)

< 1 nH per mm of lead spacing

TEST VOLTAGE BETWEEN TERMINALS

1.5 U_{Ndc} for 10 s

CLIMATIC TESTING CLASS

40/85/56

MAXIMUM APPLICATION TEMPERATURE

85 °C

MAXIMUM OPERATING TEMPERATURE (CASE)

105 °C

LIFETIME EXPECTANCY

Operation life time > 100 000 h
 FIT: < $10 \times 10^{-9}/h$ (10 per 10^9 component h) at $0.5 \times U_{Ndc}$;
 40 °C

DETAIL SPECIFICATION

For more detailed data and test requirements, contact:
dc-film@vishay.com

MKP 1848 DC-Link



Vishay Roederstein Metallized Polypropylene Film Capacitors
DC Capacitor MKP Type

COMPOSITION OF CATALOG NUMBER

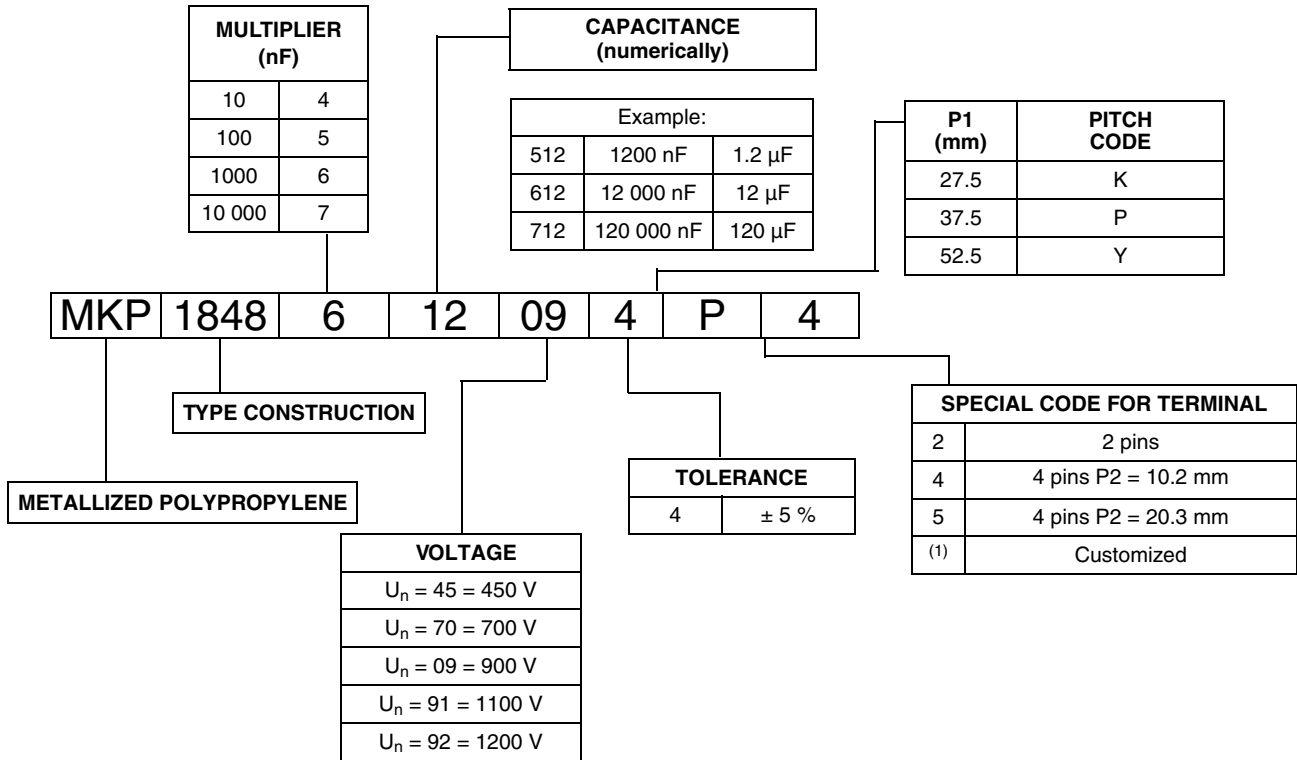

Note

(1) Tabs terminals or customized terminals are available on request

SPECIFIC REFERENCE DATA 450 Vdc

U_{Ndc} = 450 V, U_{Ndc70 °C} = 500 V, U_{Ndc105 °C} = 300 V

CAP. (5)	DIMENSIONS (mm) (4)			P1	P2	Ø d _t	dV/d _t	I _{PEAK}	I _{RMS} (A) (2)		ESR (mΩ) (3)		tan δ 1 kHz < (10 ⁻⁴)		tan δ 10 kHz < (10 ⁻⁴)		MASS (g)	SPQ (pcs)	PART NUMBER (1)
	W	H	L						2 pins	4 pins	2 pins	4 pins	2 pins	4 pins	2 pins	4 pins			
1	9.0	19.0	32.0	27.5	-	0.8	75	75	1.5	-	115	-	11.0	-	100	-	6.8	160	MKP1848510454K2
2	9.0	19.0	32.0	27.5	-	0.8	75	150	2.5	-	57.5	-	11.0	-	100	-	6.0	160	MKP1848520454K2
3	11.0	21.0	32.0	27.5	-	0.8	75	225	3.0	-	38.5	-	11.0	-	100	-	9.2	130	MKP1848530454K2
4	11.0	21.0	32.0	27.5	-	0.8	75	300	3.5	-	30.0	-	11.0	-	100	-	8.4	130	MKP1848540454K2
5	13.0	23.0	32.0	27.5	-	0.8	75	375	4.0	-	23.0	-	11.0	-	100	-	10.7	115	MKP1848550454K2
6	15.0	25.0	32.0	27.5	-	0.8	75	450	4.5	-	19.0	-	11.0	-	100	-	12.5	100	MKP1848560454K2
7	15.0	25.0	32.0	27.5	-	0.8	75	525	5.0	-	16.5	-	11.0	-	100	-	11.7	100	MKP1848570454K2
8	18.0	28.0	32.0	27.5	-	0.8	75	600	6.0	-	14.0	-	11.0	-	100	-	17.2	80	MKP1848580454K2
9	18.0	28.0	32.0	27.5	-	0.8	75	675	6.5	-	13.0	-	11.0	-	100	-	16.3	80	MKP1848590454K2
10	18.0	28.0	32.0	27.5	-	0.8	75	750	7.0	-	11.5	-	11.0	-	100	-	15.4	80	MKP1848610454K2
12	21.0	31.0	32.0	27.5	-	0.8	75	900	8.0	-	10.0	-	11.0	-	100	-	22.2	65	MKP1848612454K2
10	18.5	35.5	43.0	37.5	10.2	1.0	40	400	6.0	6.5	23.0	20.5	22.0	20.0	200	185	37.5	105	MKP1848610454P*
12	18.5	35.5	43.0	37.5	10.2	1.0	40	480	7.0	7.5	19.0	17.0	22.0	20.0	200	185	36.1	105	MKP1848612454P*
15	18.5	35.5	43.0	37.5	10.2	1.0	40	600	7.5	8.0	15.0	13.0	22.0	20.0	200	185	33.9	105	MKP1848615454P*
20	21.5	38.5	43.0	37.5	10.2	1.0	40	800	9.0	10	11.5	13.5	22.0	20.0	200	185	41.6	91	MKP1848620454P*
22	21.5	38.5	43.0	37.5	10.2	1.0	40	880	9.5	10.0	10.5	9.5	22.0	20.0	200	185	40.1	91	MKP1848622454P*
25	21.5	38.5	43.0	37.5	10.2	1.0	40	1000	10.0	10.5	9.5	8.5	22.0	20.0	200	185	37.8	91	MKP1848625454P*
30	24.0	44.0	42.0	37.5	10.2	1.0	40	1200	11.0	12.0	7.5	8.0	22.0	20.0	200	185	50	77	MKP1848630454P*



Metallized Polypropylene Film Capacitors
DC Capacitor MKP Type

Vishay Roederstein

CAP. (5) (μF)	DIMENSIONS (mm) (4)			P1 (mm)	P2 (mm)	Ø d _t (mm)	dV/dt (V/μs)	I _{PEAK} (A)	I _{RMS} (A) (2)		ESR (mΩ) (3)		tan δ 1 kHz < (10 ⁻⁴)		tan δ 10 kHz < (10 ⁻⁴)		MASS (g)	SPQ (pcs)	PART NUMBER (1)
	W	H	L						2 pins	4 pins	2 pins	4 pins	2 pins	4 pins	2 pins	4 pins			
35	30.0	45.0	42.0	37.5	10.2 / 20.3	1.0	40	1400	14.0	15.0	6.5	5.9	22.0	20.0	200	185	67	63	MKP1848635454P*
40	30.0	45.0	42.0	37.5	10.2 / 20.3	1.0	40	1600	14.5	15.5	6.0	5.0	22.0	20.0	200	185	63	63	MKP1848640454P*
40	25.0	45.0	57.5	52.5	20.3	1.2	20	800	11.0	12.0	11.5	10.0	40.0	36.0	400	370	77	55	MKP1848640454Y*
45	25.0	45.0	57.5	52.5	20.3	1.2	20	900	12.0	13.0	10.0	9.0	40.0	36.0	400	370	73	55	MKP1848645454Y*
50	30.0	45.0	57.5	52.5	20.3	1.2	20	1000	13.0	14.0	9.0	8.5	40.0	36.0	400	370	104	45	MKP1848650454Y*
55	30.0	45.0	57.5	52.5	20.3	1.2	20	1100	14.0	15.0	8.5	7.5	40.0	36.0	400	370	100	45	MKP1848655454Y*
60	30.0	45.0	57.5	52.5	20.3	1.2	20	1200	14.5	15.5	7.5	6.5	40.0	36.0	400	370	95	45	MKP1848660454Y*
65	35.0	50.0	57.5	52.5	20.3	1.2	20	1300	16.0	17.0	7.0	6.0	40.0	36.0	400	370	119	40	MKP1848665454Y*
70	35.0	50.0	57.5	52.5	20.3	1.2	20	1400	17.0	18.0	6.5	6.0	40.0	36.0	400	370	117	40	MKP1848670454Y*
75	35.0	50.0	57.5	52.5	20.3	1.2	20	1500	17.5	18.5	6.0	5.5	40.0	36.0	400	370	113	40	MKP1848675454Y*
80	35.0	50.0	57.5	52.5	20.3	1.2	20	1600	18.0	19.0	5.5	5.0	40.0	36.0	400	370	106	40	MKP1848680454Y*
90	45.0	45.0	57.5	52.5	20.3	1.2	20	1800	-	15.5	-	4.5	-	36.0	-	370	192	30	MKP1848690454Y5
95	45.0	45.0	57.5	52.5	20.3	1.2	20	1900	-	15.5	-	4.0	-	36.0	-	370	192	30	MKP1848695454Y5
100	45.0	45.0	57.5	52.5	20.3	1.2	20	2000	-	16.0	-	4.0	-	36.0	-	370	192	30	MKP1848710454Y5
200	70.0	60.0	57.5	52.5	20.3	1.2	20	2000	-	38.0	-	2.0	-	36.0	-	370	451	20	MKP1848720454Y5
400	130.0	60.0	57.5	52.5	20.3	1.2	10	4000	-	68.0	-	1.0	-	36.0	-	370	946	10	MKP1848740454Y5

Notes

- (1) Change the * symbol with special code for the terminals
- (2) Maximum rms current at 10 kHz, + 85 °C, Cap. tol. ≤ ± 5 %
- (3) Equivalent series resistance typical values at 10 kHz
- (4) Standard dimension
- (5) Intermediate capacitance values available on request.
- SPQ = Standard Packing Quantity

SPECIFIC REFERENCE DATA 700 Vdc

U_{Ndc} = 700 V, U_{Ndc70 °C} = 800 V, U_{Ndc105 °C} = 500 V

CAP. (5) (μF)	DIMENSIONS (mm) (4)			P1 (mm)	P2 (mm)	Ø d _t (mm)	dV/d _t (V/μs)	I _{PEAK} (A)	I _{RMS} (A) (2)		ESR (mΩ) (3)		tan δ 1 kHz < (10 ⁻⁴)		tan δ 10 kHz < (10 ⁻⁴)		MASS (g)	SPQ (pcs)	PART NUMBER (1)
	W	H	L						2 pins	4 pins	2 pins	4 pins	2 pins	4 pins	2 pins	4 pins			
1	9.0	19.0	32.0	27.5	-	0.8	65	65	1.5	-	94.0	-	10.0	-	85	-	6.6	160	MKP1848510704K2
2	9.0	19.0	32.0	27.5	-	0.8	65	130	2.5	-	47.0	-	10.0	-	85	-	5.6	160	MKP1848520704K2
3	11.0	21.0	32.0	27.5	-	0.8	65	195	3.0	-	31.5	-	10.0	-	85	-	8.5	130	MKP1848530704K2
4	13.0	23.0	32.0	27.5	-	0.8	65	260	4.0	-	23.5	-	10.0	-	85	-	10.5	115	MKP1848540704K2
5	15.0	25.0	32.0	27.5	-	0.8	65	325	4.5	-	19.0	-	10.0	-	85	-	12.1	100	MKP1848550704K2
6	18.0	28.0	32.0	27.5	-	0.8	65	390	6.0	-	16.0	-	10.0	-	85	-	17.4	80	MKP1848560704K2
7	18.0	28.0	32.0	27.5	-	0.8	65	455	6.5	-	13.5	-	10.0	-	85	-	16.2	80	MKP1848570704K2
8	18.0	28.0	32.0	27.5	-	0.8	65	520	7.0	-	12.0	-	10.0	-	85	-	15.1	80	MKP1848580704K2
9	21.0	31.0	32.0	27.5	-	0.8	65	585	7.5	-	10.5	-	10.0	-	85	-	22.5	65	MKP1848590704K2
10	21.0	31.0	32.0	27.5	-	0.8	65	650	8.5	-	9.5	-	10.0	-	85	-	21.3	65	MKP1848610704K2
10	18.5	35.5	43.0	37.5	10.2	1.0	30	300	7.0	7.5	19.5	17.5	19.0	17.0	170	160	35.5	105	MKP1848610704P*
12	18.5	35.5	43.0	37.5	10.2	1.0	30	360	7.5	8.0	16.5	15.0	19.0	17.0	170	160	33.7	105	MKP1848612704P*
15	18.5	35.5	43.0	37.5	10.2	1.0	30	450	8.0	9.0	13.0	11.5	19.0	17.0	170	160	30.8	105	MKP1848615704P*
20	21.5	38.5	43.0	37.5	10.2	1.0	30	600	10.0	11.0	10.0	9.0	19.0	17.0	170	160	37.3	91	MKP1848620704P*
22	24.0	44.0	42.0	37.5	10.2	1.0	30	660	11.0	12.0	9.0	8.0	19.0	17.0	170	160	51	77	MKP1848622704P*
25	24.0	44.0	42.0	37.5	10.2	1.0	30	750	12.0	13.0	8.0	7.0	19.0	17.0	170	160	48	77	MKP1848625704P*
30	30.0	45.0	42.0	37.5	10.2 / 20.3	1.0	30	900	14.0	14.5	6.5	6.0	19.0	17.0	170	160	64	63	MKP1848630704P*
35	30.0	45.0	42.0	37.5	10.2 / 20.3	1.0	30	1050	15.0	15.5	5.5	5.0	19.0	17.0	170	160	58	63	MKP1848635704P*
30	25.0	45.0	57.5	52.5	20.3	1.2	15	450	10.5	11.5	13.0	11.5	35.0	33.0	350	320	78	55	MKP1848630704Y*
35	25.0	45.0	57.5	52.5	20.3	1.2	15	525	11.5	12.0	11.0	10.0	35.0	33.0	350	320	73	55	MKP1848635704Y*
40	25.0	45.0	57.5	52.5	20.3	1.2	15	600	12.0	12.5	10.0	9.0	35.0	33.0	350	320	68	55	MKP1848640704Y*

MKP 1848 DC-Link



Vishay Roederstein Metallized Polypropylene Film Capacitors
DC Capacitor MKP Type

CAP. (5) (μF)	DIMENSIONS (mm) (4)			P1 (mm)	P2 (mm)	$\varnothing d_t$ (mm)	dV/dt (V/ μs)	I _{PEAK} (A)	I _{RMS} (A) (2)		ESR (m Ω) (3)		tan δ 1 kHz < (10 ⁻⁴)		tan δ 10 kHz < (10 ⁻⁴)		MASS (g)	SPQ (pcs)	PART NUMBER (1)
									2 pins	4 pins	2 pins	4 pins	2 pins	4 pins	2 pins	4 pins			
45	30.0	45.0	57.5	52.5	20.3	1.2	15	675	13.5	14.5	9.0	7.5	35.0	33.0	350	320	99	45	MKP1848645704Y*
50	30.0	45.0	57.5	52.5	20.3	1.2	15	750	14.5	15.5	8.0	7.0	35.0	33.0	350	320	92	45	MKP1848650704Y*
55	35.0	50.0	57.5	52.5	20.3	1.2	15	825	16.0	17.0	7.0	6.5	35.0	33.0	350	320	117	40	MKP1848655704Y*
60	35.0	50.0	57.5	52.5	20.3	1.2	15	900	17.0	18.0	6.5	6.0	35.0	33.0	350	320	112	40	MKP1848660704Y*
65	35.0	50.0	57.5	52.5	20.3	1.2	15	975	17.5	18.5	6.0	5.5	35.0	33.0	350	320	104	40	MKP1848665704Y*
70	45.0	45.0	57.5	52.5	20.3	1.2	15	1050	-	20.0	-	5.0	-	33.0	-	320	192	30	MKP1848670704Y5
75	45.0	45.0	57.5	52.5	20.3	1.2	15	1125	-	21.0	-	4.5	-	33.0	-	320	192	30	MKP1848675704Y5
80	45.0	45.0	57.5	52.5	20.3	1.2	15	1200	-	21.5	-	4.5	-	33.0	-	320	192	30	MKP1848680704Y5
160	70.0	60.0	57.5	52.5	20.3	1.2	15	2400	-	38.0	-	2.2	-	33.0	-	320	451	20	MKP1848716704Y5
320	130.0	60.0	57.5	52.5	20.3	1.2	15	4800	-	65.0	-	1.0	-	33.0	-	320	821	10	MKP1848732704Y5

Notes

- (1) Change the * symbol with special code for the terminals
 - (2) Maximum rms current at 10 kHz, + 85 °C, Cap. tol. $\leq \pm 5\%$
 - (3) Equivalent series resistance typical values at 10 kHz
 - (4) Standard dimension
 - (5) Intermediate capacitance values are available on request.
- SPQ = Standard Packing Quantity

SPECIFIC REFERENCE DATA 900 Vdc

U_{Ndc} = 900 V, U_{Ndc70 °C} = 1100 V, U_{Ndc105 °C} = 650 V

CAP. (5) (μF)	DIMENSIONS (mm) (4)			P1 (mm)	P2 (mm)	$\varnothing d_t$ (mm)	dV/dt (V/ μs)	I _{PEAK} (A)	I _{RMS} (A) (2)		ESR (m Ω) (3)		tan δ 1 kHz < (10 ⁻⁴)		tan δ 10 kHz < (10 ⁻⁴)		MASS (g)	SPQ (pcs)	PART NUMBER (1)
									2 pins	4 pins	2 pins	4 pins	2 pins	4 pins	2 pins	4 pins			
1.0	9.0	19.0	32.0	27.5	-	0.8	80	80	2.0	-	88.0	-	8.0	-	65	-	5.9	160	MKP1848510094K2
2.0	13.0	23.0	32.0	27.5	-	0.8	80	160	2.5	-	44.0	-	8.0	-	65	-	11.3	115	MKP1848520094K2
3.0	15.0	25.0	32.0	27.5	-	0.8	80	240	3.5	-	29.5	-	8.0	-	65	-	12.1	100	MKP1848530094K2
4.0	18.0	28.0	32.0	27.5	-	0.8	80	320	4.0	-	22.0	-	8.0	-	65	-	16.7	80	MKP1848540094K2
5.0	21.0	31.0	32.0	27.5	-	0.8	80	400	5.0	-	18.0	-	8.0	-	65	-	23.3	65	MKP1848550094K2
6.0	21.0	31.0	32.0	27.5	-	0.8	80	480	5.5	-	15.0	-	8.0	-	65	-	21.4	65	MKP1848560094K2
5.0	18.5	35.5	43.0	37.5	10.2	1.0	40	200	4.0	4.5	36.5	32.0	15.0	13	140	125	37.1	105	MKP1848550094P*
6.0	18.5	35.5	43.0	37.5	10.2	1.0	40	240	4.5	5.0	30.0	27.0	15.0	13	140	125	35.6	105	MKP1848560094P*
7.0	18.5	35.5	43.0	37.5	10.2	1.0	40	280	5.0	5.5	26.0	23.5	15.0	13	140	125	34.1	105	MKP1848570094P*
8.0	18.5	35.5	43.0	37.5	10.2	1.0	40	320	5.0	5.5	22.5	20.5	15.0	13	140	125	32.5	105	MKP1848580094P*
9.0	18.5	35.5	43.0	37.5	10.2	1.0	40	360	5.5	6.0	20.0	18.5	15.0	13	140	125	30.9	105	MKP1848590094P*
10.0	21.5	38.5	43.0	37.5	10.2	1.0	40	400	6.0	6.5	18.5	16.5	15.0	13	140	125	40.7	91	MKP1848610094P*
12.0	21.5	38.5	43.0	37.5	10.2	1.0	40	480	6.5	7.0	15.0	13.5	15.0	13	140	125	37.5	91	MKP1848612094P*
15.0	24.0	44.0	42.0	37.5	10.2	1.0	40	600	8.0	8.5	12.5	11.0	15.0	13	140	125	48.9	77	MKP1848615094P*
16.0	24.0	44.0	42.0	37.5	10.2	1.0	40	640	8.0	8.5	11.5	10.5	15.0	13	140	125	47.2	77	MKP1848616094P*
20.0	30.0	45.0	42.0	37.5	10.2/20.3	1.0	40	800	9.5	10.0	9.5	8.5	15.0	13	140	125	60	63	MKP1848620094P*
15.0	25.0	45.0	57.5	52.5	20.3	1.2	20	300	6.5	7.5	24.5	22.0	30.0	25	275	250	83	55	MKP1848615094Y*
20.0	25.0	45.0	57.5	52.5	20.3	1.2	20	400	7.0	8.0	18.5	16.5	30.0	25	275	250	75	55	MKP1848620094Y*
22.0	25.0	45.0	57.5	52.5	20.3	1.2	20	440	7.5	8.5	16.5	15.0	30.0	25	275	250	72	55	MKP1848622094Y*
25.0	30.0	45.0	57.5	52.5	20.3	1.2	20	500	8.5	9.5	14.5	13.5	30.0	25	275	250	102	45	MKP1848625094Y*
30.0	30.0	45.0	57.5	52.5	20.3	1.2	20	600	9.5	10.5	12.5	11.0	30.0	25	275	250	92	45	MKP1848630094Y*
35.0	35.0	50.0	57.5	52.5	20.3	1.2	20	700	10.5	11.5	10.5	9.5	30.0	25	275	250	114	40	MKP1848635094Y*
40.0	35.0	50.0	57.5	52.5	20.3	1.2	20	800	12.0	13.0	9.5	8.5	30.0	25	275	250	103	40	MKP1848640094Y*
45.0	45.0	45.0	57.5	52.5	20.3	1.2	20	900	-	14.0	-	7.5	-	25	-	250	192	30	MKP1848645094Y5
50.0	45.0	45.0	57.5	52.5	20.3	1.2	20	1000	-	14.5	-	6.5	-	25	-	250	191	30	MKP1848650094Y5
100.0	70.0	60.0	57.5	52.5	20.3	1.2	20	2000	-	25.0	-	3.5	-	25	-	250	452	20	MKP1848710094Y5

Notes

- (1) Change the * symbol with special code for the terminals
 - (2) Maximum rms current at 10 kHz, + 85 °C, Cap. tol. $\leq \pm 5\%$
 - (3) Equivalent series resistance typical values at 10 kHz
 - (4) Standard dimension
 - (5) Intermediate capacitance values are available on request.
- SPQ = Standard Packing Quantity



**Metallized Polypropylene Film Capacitors
DC Capacitor MKP Type**

Vishay Roederstein

SPECIFIC REFERENCE DATA 1100 Vdc

$U_{Ndc} = 1100\text{ V}$, $U_{Ndc70^\circ\text{C}} = 1350\text{ V}$, $U_{Ndc105^\circ\text{C}} = 800\text{ V}$

CAP. (5)	DIMENSIONS (mm) (4)			P1	P2	Ø d _t	dV/d _t	I _{PEAK}	I _{RMS} (A) (2)		ESR (mΩ) (3)		tan δ 1 kHz < (10 ⁻⁴)		tan δ 10 kHz < (10 ⁻⁴)		MASS (g)	SPQ (pcs)	PART NUMBER (1)
	(µF)	W	H						L	(mm)	(mm)	(mm)	(V/µs)	(A)	2 pins	4 pins			
1	11.0	21.0	32.0	27.5	-	0.8	95	95	2.5	-	62.0	-	7.0	-	55	-	9.1	130	MKP1848510914K2
2	15.0	25.0	32.0	27.5	-	0.8	95	190	3.5	-	31.0	-	7.0	-	55	-	12.3	100	MKP1848520914K2
3	18.0	28.0	32.0	27.5	-	0.8	95	285	5.0	-	21.0	-	7.0	-	55	-	16.0	80	MKP1848530914K2
4	21.0	31.0	32.0	27.5	-	0.8	95	380	6.5	-	15.5	-	7.0	-	55	-	21.8	65	MKP1848540914K2
5	18.5	35.5	43.0	37.5	10.2	1.0	45	225	5.5	6.0	25.5	23.0	13.0	12.0	115	105	33.7	105	MKP1848550914P*
6	18.5	35.5	43.0	37.5	10.2	1.0	45	270	6.0	6.5	21.5	19.0	13.0	12.0	115	105	31.4	105	MKP1848560914P*
7	21.5	38.5	43.0	37.5	10.2	1.0	45	315	7.0	7.5	18.5	16.5	13.0	12.0	115	105	40.5	91	MKP1848570914P*
8	21.5	38.5	43.0	37.5	10.2	1.0	45	360	4.5	5.0	16.0	14.5	13.0	12.0	115	105	38.2	91	MKP1848580914P*
9	24.0	44.0	42.0	37.5	10.2	1.0	45	405	8.5	9.0	14.0	13.0	13.0	12.0	115	105	52	77	MKP1848590914P*
10	24.0	44.0	42.0	37.5	10.2	1.0	45	450	9.0	9.5	13.0	11.5	13.0	12.0	115	105	49	77	MKP1848610914P*
12	30.0	45.0	42.0	37.5	10.2 / 20.3	1.0	45	540	10.5	11.0	10.5	9.5	13.0	12.0	115	105	66	63	MKP1848612914P*
10	25.0	45.0	57.5	52.5	20.3	1.2	23	230	7.5	8.5	25.5	23.0	25.0	22.0	230	210	84	55	MKP1848610914Y*
12	25.0	45.0	57.5	52.5	20.3	1.2	23	276	8.0	9.0	21.5	19.5	25.0	22.0	230	210	80	55	MKP1848612914Y*
15	25.0	45.0	57.5	52.5	20.3	1.2	23	345	9.0	10.0	17.0	15.5	25.0	22.0	230	210	73	55	MKP1848615914Y*
20	30.0	45.0	57.5	52.5	20.3	1.2	23	460	11.0	12.0	12.5	11.5	25.0	22.0	230	210	94	45	MKP1848620914Y*
22	35.0	50.0	57.5	52.5	20.3	1.2	23	506	12.5	13.5	11.5	10.5	25.0	22.0	230	210	119	40	MKP1848622914Y*
25	35.0	50.0	57.5	52.5	20.3	1.2	23	575	13.5	14.5	10.5	9.0	25.0	22.0	230	210	112	40	MKP1848625914Y*
30	45.0	45.0	57.5	52.5	20.3	1.2	23	720	-	16.5	-	7.5	-	22.0	-	210	192	30	MKP1848630914Y5
60	70.0	60.0	57.5	52.5	20.3	1.2	23	1500	-	30.0	-	3.5	-	22.0	-	210	452	20	MKP1848660914Y5

Notes

- (1) Change the * symbol with special code for the terminals
- (2) Maximum rms current at 10 kHz, + 85 °C, Cap. tol. ≤ ± 5 %
- (3) Equivalent series resistance typical values at 10 kHz
- (4) Standard dimension
- (5) Intermediate capacitance values are available on request.
- SPQ = Standard Packing Quantity

SPECIFIC REFERENCE DATA 1200 Vdc

$U_{Ndc} = 1200\text{ V}$, $U_{Ndc70^\circ\text{C}} = 1500\text{ V}$, $U_{Ndc105^\circ\text{C}} = 850\text{ V}$

CAP. (5)	DIMENSIONS (mm) (4)			P1	P2	Ø d _t	dV/d _t	I _{PEAK}	I _{RMS} (A) (2)		ESR (mΩ) (3)		tan δ 1 kHz < (10 ⁻⁴)		tan δ 10 kHz < (10 ⁻⁴)		MASS (g)	SPQ (pcs)	PART NUMBER (1)
	(µF)	W	H						L	(mm)	(mm)	(mm)	(V/µs)	(A)	2 pins	4 pins			
1	11.0	21.0	32.0	27.5	-	0.8	100	100	2.5	-	60.0	-	6.0	-	54	-	8.8	130	MKP1848510924K2
2	15.0	25.0	32.0	27.5	-	0.8	100	200	4.0	-	30.0	-	6.0	-	54	-	11.7	100	MKP1848520924K2
3	18.0	28.0	32.0	27.5	-	0.8	100	300	5.0	-	20.0	-	6.0	-	54	-	15.2	80	MKP1848530924K2
4	21.0	31.0	32.0	27.5	-	0.8	100	400	6.5	-	15.0	-	6.0	-	54	-	20.6	65	MKP1848540924K2
5	18.5	35.5	43.0	37.5	10.2	1.0	48	240	6.0	6.5	24.5	22.0	12.0	11.0	110	100	32.5	105	MKP1848550924P*
6	18.5	35.5	43.0	37.5	10.2	1.0	48	288	6.5	7.0	20.0	18.5	12.0	11.0	110	100	30.0	105	MKP1848560924P*
7	21.5	38.5	43.0	37.5	10.2	1.0	48	336	7.5	8.0	17.5	15.5	12.0	11.0	110	100	38.9	91	MKP1848570924P*
8	21.5	38.5	43.0	37.5	10.2	1.0	48	384	8.0	8.5	15.5	14.0	12.0	11.0	110	100	36.3	91	MKP1848580924P*
9	24.0	44.0	42.0	37.5	10.2	1.0	48	432	9.0	9.5	13.5	12.5	12.0	11.0	110	100	50	77	MKP1848590924P*
10	24.0	44.0	42.0	37.5	10.2	1.0	48	480	9.5	10.0	12.5	11.0	12.0	11.0	110	100	47	77	MKP1848610924P*
12	30.0	45.0	42.0	37.5	10.2 / 20.3	1.0	48	576	11.0	11.5	10.0	9.0	12.0	11.0	110	100	63	63	MKP1848612924P*
10	25.0	45.0	57.5	52.5	20.3	1.2	24	240	7.5	8.5	24.5	21.5	23.0	21.0	220	200	82	55	MKP1848610924Y*
12	25.0	45.0	57.5	52.5	20.3	1.2	24	288	8.5	9.5	20.5	18.5	23.0	21.0	220	200	77	55	MKP1848612924Y*

CAP. (5)	DIMENSIONS (mm) (4)			P1	P2	Ø d _t	dV/dt	I _{PEAK}	I _{RMS} (A)		ESR (mΩ) (3)		tan δ 1 kHz < (10 ⁻⁴)		tan δ 10 kHz < (10 ⁻⁴)		MASS (g)	SPQ (pcs)	PART NUMBER (1)
	(µF)	W	H						L	(mm)	(mm)	(mm)	(V/µs)	(A)	2 pins	4 pins			
15	25.0	45.0	57.5	52.5	20.3	1.2	24	360	9.5	10.5	16.5	14.5	23.0	21.0	220	200	69	55	MKP1848615924Y*
20	35.0	50.0	57.5	52.5	20.3	1.2	24	480	12.5	13.5	12.5	11.0	23.0	21.0	220	200	119	40	MKP1848620924Y*
22	35.0	50.0	57.5	52.5	20.3	1.2	24	528	13.0	14.0	11.0	10.0	23.0	21.0	220	200	114	40	MKP1848622924Y*
25	35.0	50.0	57.5	52.5	20.3	1.2	24	600	14.0	15.0	10.0	9.0	23.0	21.0	220	200	104	40	MKP1848625924Y*
30	45.0	45.0	57.5	52.5	20.3	1.2	24	750	-	17.0	-	7.0	-	21.0	-	200	191	30	MKP1848630924Y5
60	70.0	60.0	57.5	52.5	20.3	1.2	24	1560	-	28.5	-	3.5	-	21.0	-	200	450	15	MKP1848660924Y5

Notes

- (1) Change the * symbol with special code for the terminals
- (2) Maximum rms current at 10 kHz, + 85 °C, Cap. tol. ≤ ± 5 %
- (3) Equivalent series resistance typical values at 10 kHz
- (4) Standard dimension
- (5) Intermediate capacitance values are available on request.
- SPQ = Standard Packing Quantity

CONSTRUCTION

Description

Low inductive wound cell elements of metallised polypropylene film, potted with resin in a flame retardant case.

MOUNTING

The capacitors unit is designed for mounting on PCB. The capacitors shall be mechanically fixed by the leads and body must be clamped to withstand vibration and shock.

Space Requirements on Printed-Circuit Board

The maximum length and width of film capacitors is shown in the figure:

- Eccentricity as in figure. The maximum eccentricity is smaller than or equal to the lead diameter of the product concerned
- Product height with seating plane as given by "IEC 60717" as reference: $h_{max.} \leq h + 0.5 \text{ mm}$

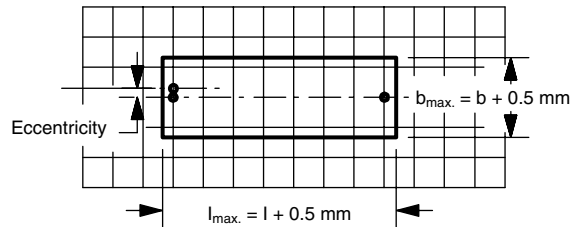

Storage temperature

- Storage temperature: T_{stg} = - 25 °C to + 40 °C with RH maximum 80 % without condensation

Ratings and Characteristics Reference Conditions

Unless otherwise specified, all electrical values apply to an ambient free temperature of 23 °C ± 1 °C, an atmospheric pressure of 86 kPa to 106 kPa and a relative humidity of 50 % ± 2 %.

For reference testing, a conditioning period shall be applied over 96 h ± 4 h by heating the products in a circulating air oven at the rated temperature and a relative humidity not exceeding 20 %.



CHARACTERISTICS

Capacitance (typical curve)

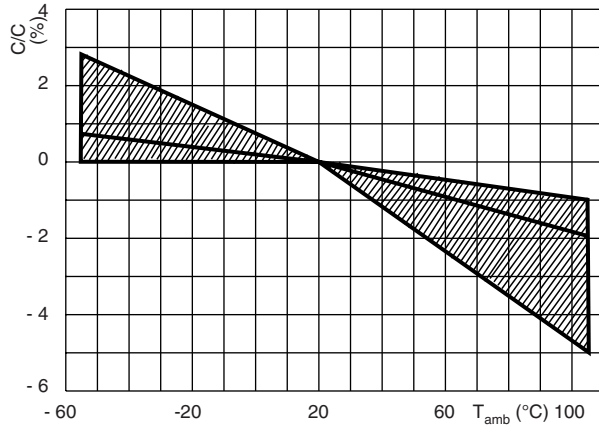

Insulation resistance (typical curve)

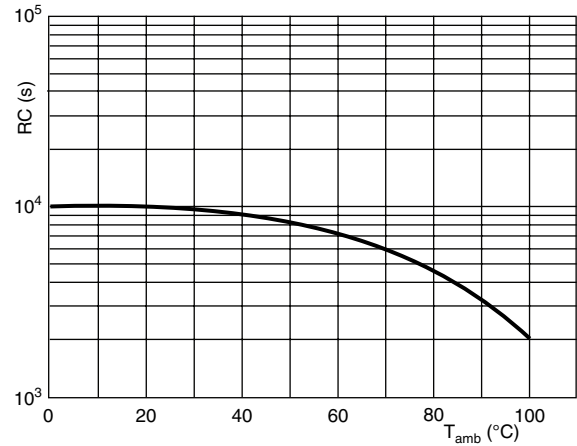

Lifetime expectancy (typical curve)

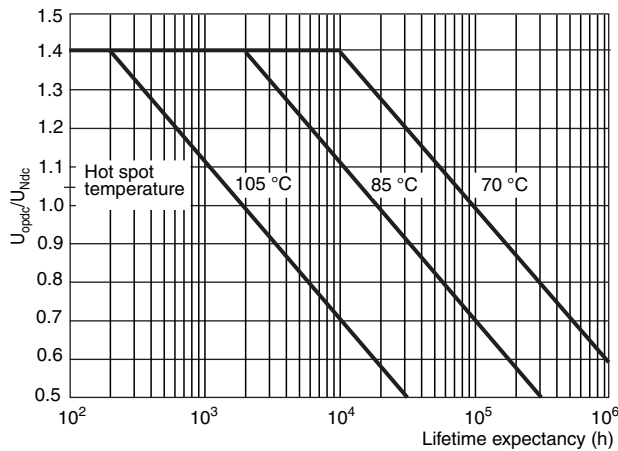

Impedance vs. frequency (typical curve)

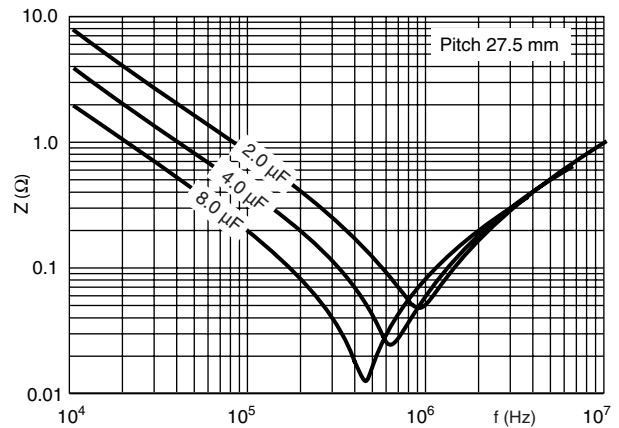

Impedance vs. frequency (typical curve)

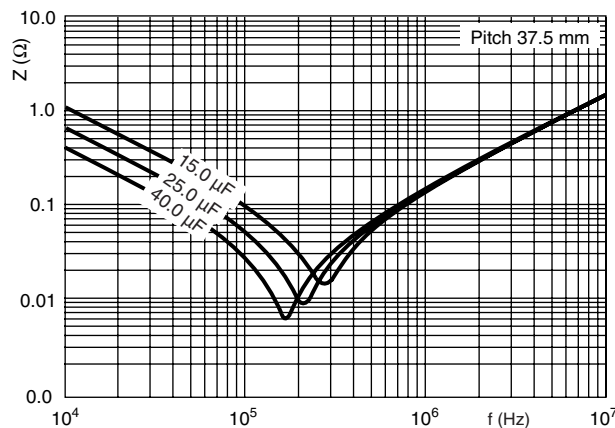

Impedance vs. frequency (typical curve)

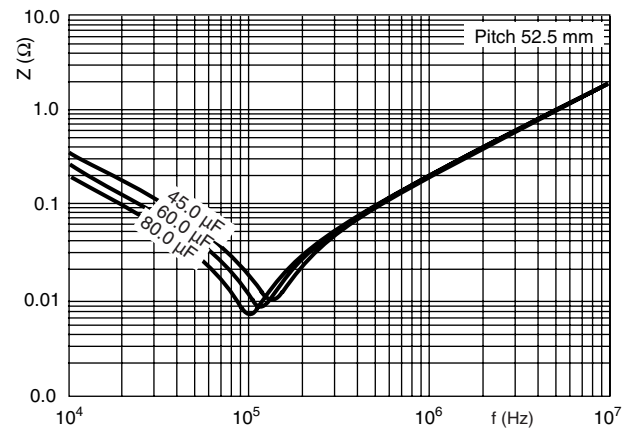

MAXIMUM PEAK TO PEAK RIPPLE VOLTAGE AS A FUNCTION OF FREQUENCY

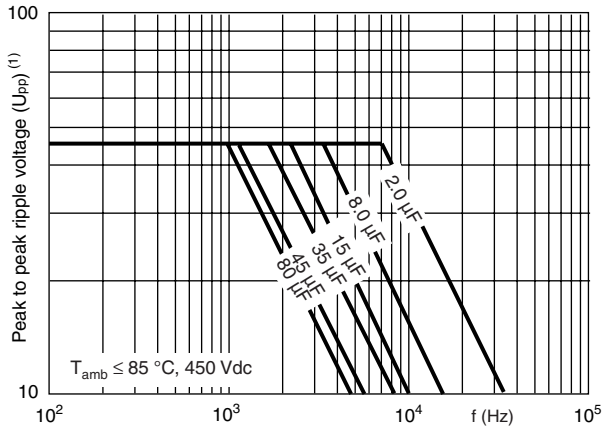

⁽¹⁾ Limited by maximum ripple voltage $0.1 \times U_{Ndc}$

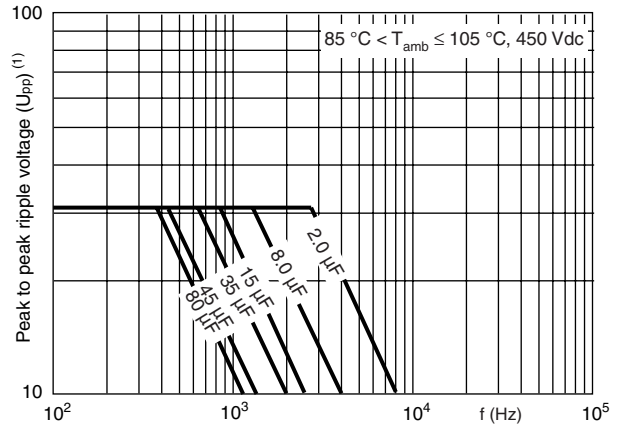

⁽¹⁾ Limited by maximum ripple voltage $0.1 \times U_{Ndc}$

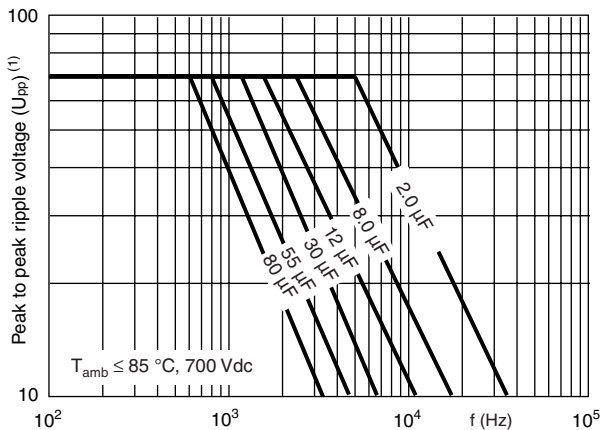

⁽¹⁾ Limited by maximum ripple voltage $0.1 \times U_{Ndc}$

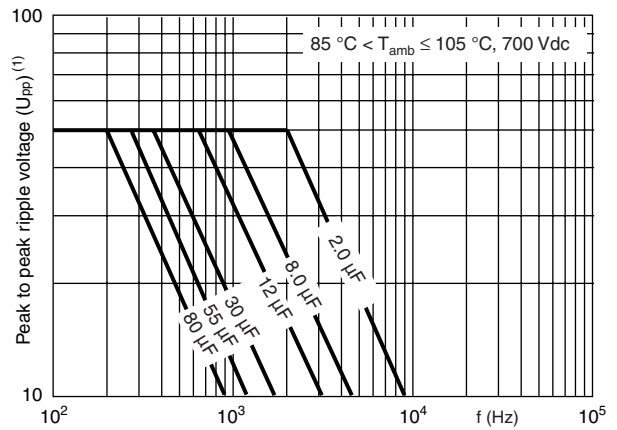

⁽¹⁾ Limited by maximum ripple voltage $0.1 \times U_{Ndc}$

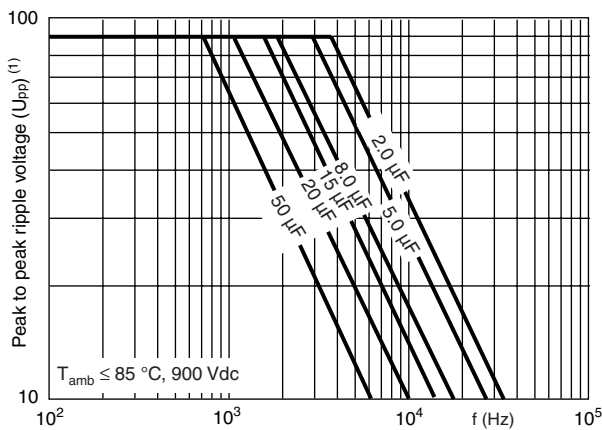

⁽¹⁾ Limited by maximum ripple voltage $0.1 \times U_{Ndc}$

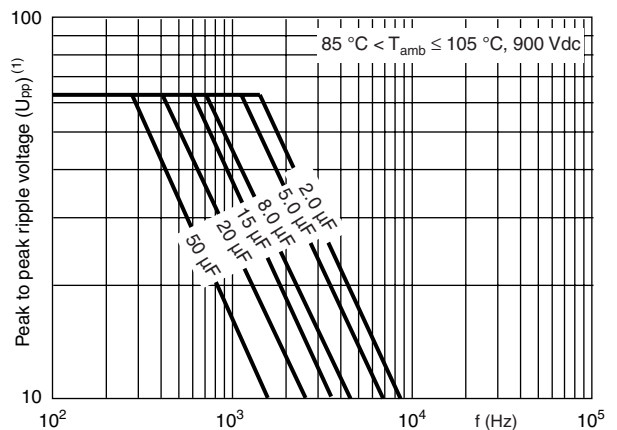

⁽¹⁾ Limited by maximum ripple voltage $0.1 \times U_{Ndc}$



MAXIMUM PEAK TO PEAK RIPPLE VOLTAGE AS A FUNCTION OF FREQUENCY

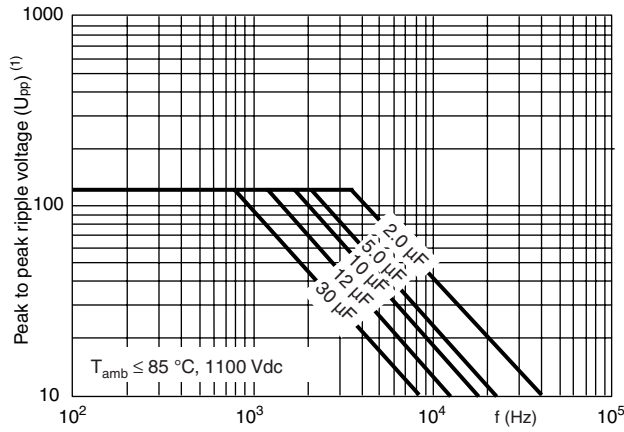

⁽¹⁾ Limited by maximum ripple voltage $0.1 \times U_{Ndc}$

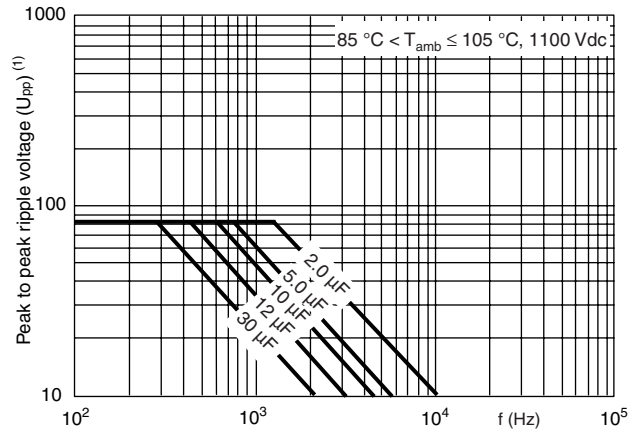

⁽¹⁾ Limited by maximum ripple voltage $0.1 \times U_{Ndc}$

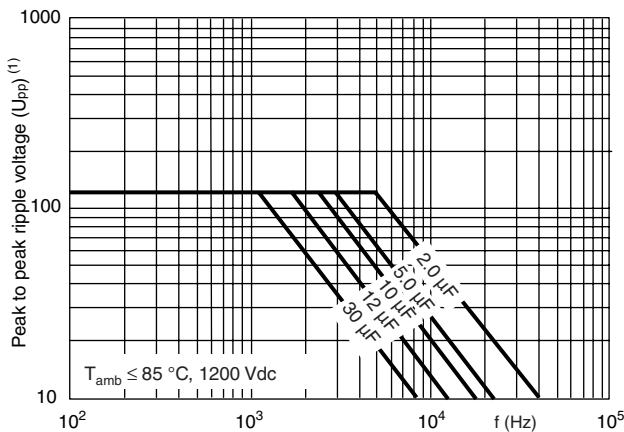

⁽¹⁾ Limited by maximum ripple voltage $0.1 \times U_{Ndc}$

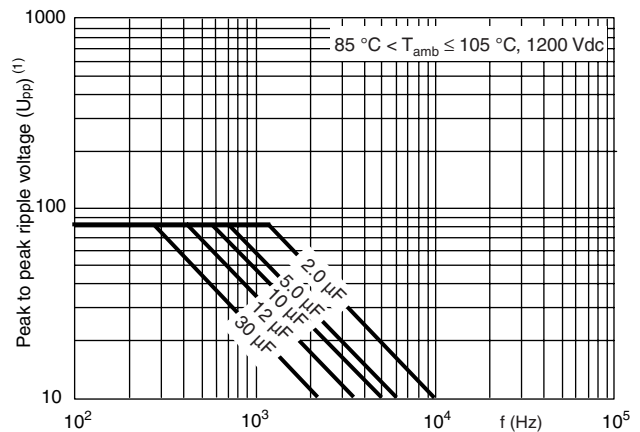

⁽¹⁾ Limited by maximum ripple voltage $0.1 \times U_{Ndc}$

HEAT CONDUCTIVITY AND HOT SPOT TEMPERATURE

W _{max.} (mm)	HEAT CONDUCTIVITY (mW/°C)		
	PITCH 27.5 mm	PITCH 37.5 mm	PITCH 52.5 mm
9.0	31	-	-
11.0	37	-	-
13.0	42	-	-
15.0	48	-	-
18.0	58	-	-
18.5	-	89	-
21.0	68	-	-
21.5	-	102	-
24.0	-	116	-
25.0	-	-	152
30.0	-	134	181
35.0	-	-	197
45.0	-	-	213
87.0	-	-	341

POWER DISSIPATION AND MAXIMUM COMPONENT TEMPERATURE RISE

The power dissipation must be limited in order not to exceed the maximum allowed component temperature rise as a function of the free air ambient temperature.

The component temperature rise (ΔT) can be measured or calculated by $\Delta T = P/G$:

- ΔT = Component temperature rise (°C)
- P = Power dissipation of the component (mW)
- G = Heat conductivity of the component (mW/°C)

MEASURING THE COMPONENT TEMPERATURE

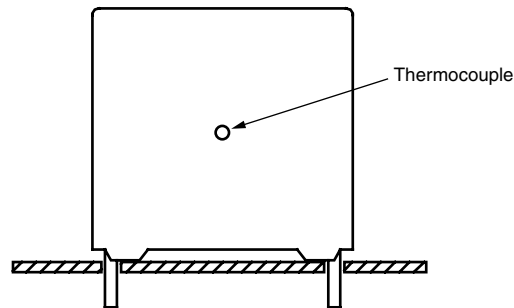

The temperature is measured in unloaded (T_{amb}) and maximum loaded condition (T_C).

The temperature rise is given by $\Delta T = T_C - T_{amb}$.

To avoid thermal radiation or convection, the capacitor must be tested in a closed area from air circulation.

APPLICATION NOTE AND LIMITING CONDITIONS

These capacitors are not suitable for mains applications as across-the-line capacitors without additional protection. These mains applications are strictly regulated in safety standards and therefore electromagnetic interference suppression capacitors conforming the standards must be used.

To select the capacitor for a certain application, the following conditions must be checked:

1. The peak voltage (U_{p+}) shall not be greater than the rated DC voltage (U_{Ndc})
2. The peak-to-peak ripple voltage (U_{p-p}) shall not be greater than $0.1 \times (U_{Ndc})$

Non reversing recurrent waveform

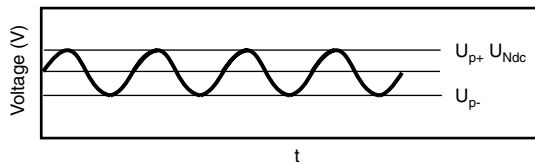

3. The voltage peak slope (dU/dt) shall not exceed the pulse slope at the DC voltage rating.
 If the pulse voltage is lower than the rated DC voltage, the rated voltage pulse slope may be multiplied by U_{Ndc} and divided by the applied voltage.

For all other pulses following equation must be fulfilled:

$$2 \times \int_0^T \left(\frac{dU}{dt} \right)^2 \times dt < U_{Ndc} \times \left(\frac{dU}{dt} \right)_{rated}$$

T is the pulse duration

4. The maximum component surface temperature rise must be lower than 15 °C.

MAXIMUM REPETITIVE PEAK VOLTAGES

The capacitor unit may be subjected to the following surge without any significant reduction of lifetime expectancy

REPETITIVE SURGE VOLTAGE	MAXIMUM DURATION PER DAY
$1.1 \times U_{Ndc}$	30 % on load duration
$1.15 \times U_{Ndc}$	30 min
$1.2 \times U_{Ndc}$	5 min
$1.3 \times U_{Ndc}$	1 min
$1.5 \times U_{Ndc}$	110 ms

INSPECTION REQUIREMENTS

General Notes:

Sub-clause numbers of tests and performance requirements refer to the "Sectional Specification, Publication IEC 61071.

SUB-CLAUSE NUMBER AND TEST	CONDITIONS	PERFORMANCE REQUIREMENTS
ROUTINE TEST-FINAL INSPECTION		
5.14.2.1 External inspection, visual examination		Legible marking as specified
5.14.2.2 Dimensions		See specification drawing
5.3.1 Capacitance	1 kHz at room temperature	See specific reference data
5.3.2 tan δ	1 kHz at room temperature 10 kHz at room temperature	See specific reference data
5.5.1.2 Voltage test between terminal	1.5 x U_{Ndc} at T_{amb} Duration 10 s	No visible damage or puncture No flashover
5.7 Insulation resistance	$U_{Ndc} \leq 500$ V measuring voltage 100 V at room temperature $U_{Ndc} > 500$ V measuring voltage 500 V at room temperature Duration 1 min	See specific reference data
TYPE TESTS		
5.14.2 External inspection	Check for finish, marking and overall dimensions	Legible marking and finish as specified Dimensions: see specific drawing
5.14.0 Initial measurements	Capacitance at 1 kHz tan δ at 10 kHz	
5.14.1.1.4 Robustness of terminations IEC 60068-2-21	Tensile U_a1 Wire diameter section load ≤ 0.8 mm ≤ 0.5 mm ² 10 N ≤ 1.25 mm ≤ 1.2 mm ² 20 N Duration 10 s \pm 1 s Bending U_b method 1 Wire diameter section load ≤ 0.8 mm ≤ 0.05 mm ³ 10 N ≤ 1.25 mm ≤ 0.019 mm ³ 20 N 4 x 90 °, Duration 2 s to 3 s/bend	
5.14.1.6 Resistance to soldering heat IEC 60068-2-20	No predrying, Method 1A Solder bath: 260 °C \pm 5 °C	
5.14.4 Final measurements	Capacitance tan δ	$ \Delta C/C \leq 0.5$ % Increase of tan $\delta \leq 0.0050$ Compared to values measured in 5.14.0
5.14.0 Initial measurements	Capacitance at 1 kHz tan δ at 10 kHz	
5.14.3.1 Vibration IEC 60068-2-6	10 Hz to 55 Hz: amplitude \pm 0.35 mm or acceleration 98 m/s ² Test duration: 10 frequency cycles, 3 axes offset from each other by 90° 1 octave/min	No visible damage
5.14.3.2 Shock or impact IEC 60068-2-6	Pulse shape: half sine Acceleration: 490 m/s ² Duration t of pulse: 11 ms Visual examination	No visible damage
5.14.4 Final measurements	Capacitance tan δ	$ \Delta C/C \leq 0.5$ % Increase of tan $\delta \leq 0.0050$ Compared to values measured in 5.14.0



Disclaimer

All product specifications and data are subject to change without notice.

Vishay Intertechnology, Inc., its affiliates, agents, and employees, and all persons acting on its or their behalf (collectively, "Vishay"), disclaim any and all liability for any errors, inaccuracies or incompleteness contained herein or in any other disclosure relating to any product.

Vishay disclaims any and all liability arising out of the use or application of any product described herein or of any information provided herein to the maximum extent permitted by law. The product specifications do not expand or otherwise modify Vishay's terms and conditions of purchase, including but not limited to the warranty expressed therein, which apply to these products.

No license, express or implied, by estoppel or otherwise, to any intellectual property rights is granted by this document or by any conduct of Vishay.

The products shown herein are not designed for use in medical, life-saving, or life-sustaining applications unless otherwise expressly indicated. Customers using or selling Vishay products not expressly indicated for use in such applications do so entirely at their own risk and agree to fully indemnify Vishay for any damages arising or resulting from such use or sale. Please contact authorized Vishay personnel to obtain written terms and conditions regarding products designed for such applications.

Product names and markings noted herein may be trademarks of their respective owners.