

450-3326 Solder mount socket, for .059 (1,52) to .062 (1,57) diameter pins

Recommended mounting hole .102 (2,59) ± .002 (0,05), #38 drill

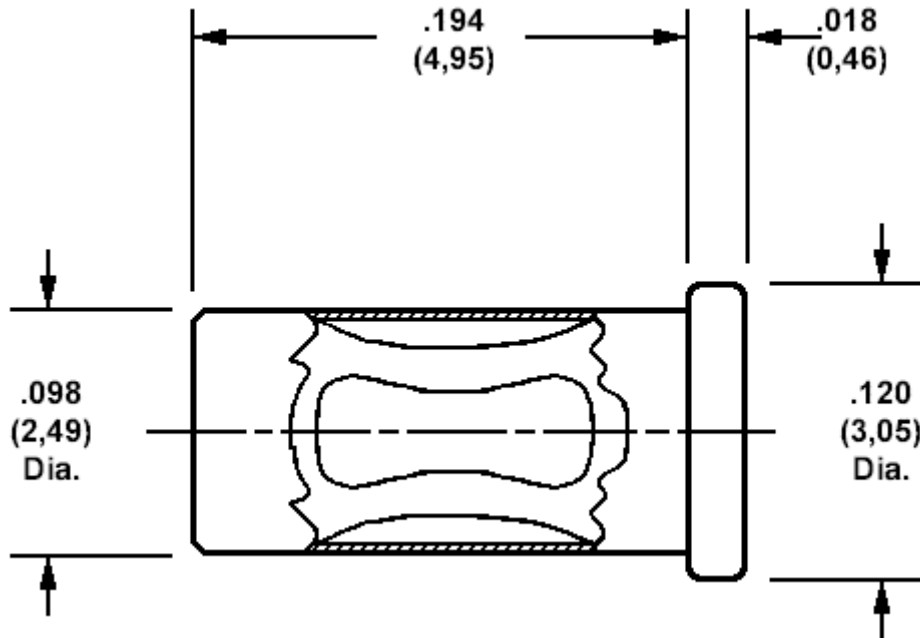

Min hole depth .200 (5,08)

How to order code
450-3326-01-XX-00
 Basic Part No XX = Finish

MATERIALS				
Component	Material	Finish(-03)	Finish(-04)	Finish(-06)
Body	Brass	Gold over Nickel	Tin	Tin
Spring	Beryllium copper	Gold over Nickel	Tin	Gold over Nickel