



S I L I C O N L A B S

Si500 Silicon Oscillator
Product Family

September 2008

Introducing the Si500 Silicon Oscillator



- ◆ All silicon oscillator enables replacement of quartz and MEMS XOs with IC solution
 - Supports any frequency from 0.9 to 200 MHz
- ◆ CMOS based architecture
 - Improves reliability and performance
- ◆ High volume IC manufacturing flow enables short lead times



Si500 Replaces Quartz Oscillators

Traditional Approach

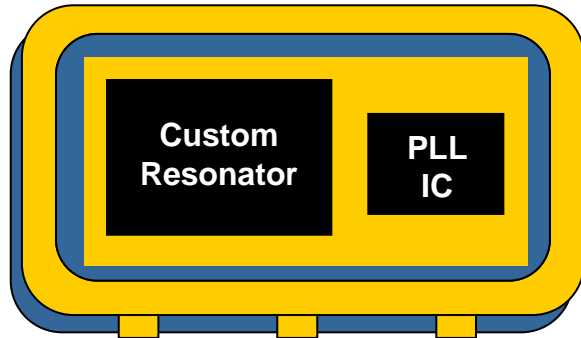

- ◆ Unique resonator required for each output frequency
- ◆ Custom frequencies require fabrication and qualification of new resonator
- ◆ Costly ceramic or metal packaging with hermetic sealing
- ◆ Complex manufacturing flow causes long, unpredictable lead times

Silicon Labs



- ◆ Silicon Labs IC synthesizes all frequencies from single CMOS oscillator
- ◆ Factory-programmable to any frequency from to 200 MHz
- ◆ Standard IC plastic packaging (3.2x4 mm DFN)
- ◆ Short lead times (<2 weeks for samples)



Frequency Control Market

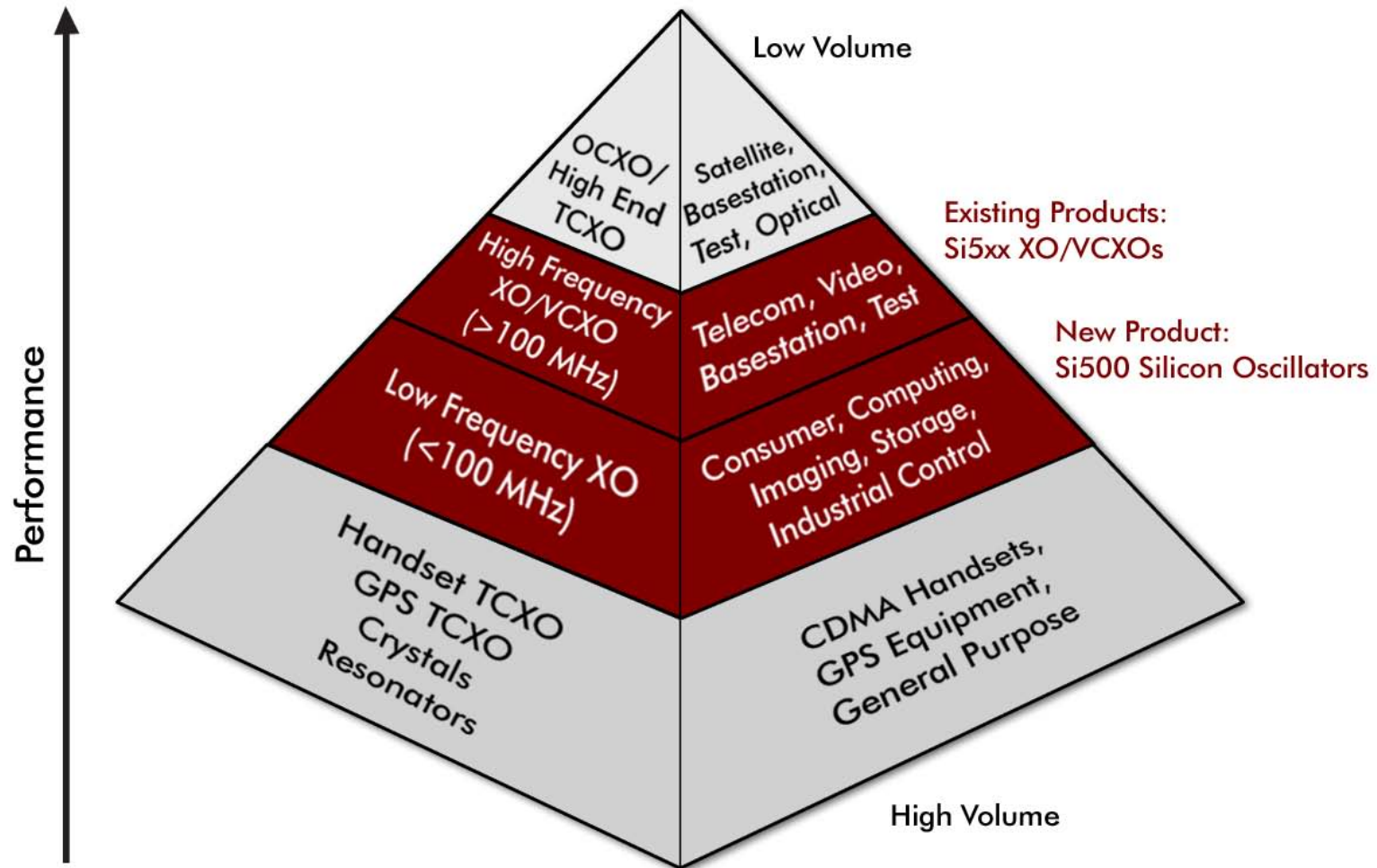

- ◆ Si500 targets high volume <100 MHz XO market

Leapfrogs MEMS and Traditional Silicon Oscillators

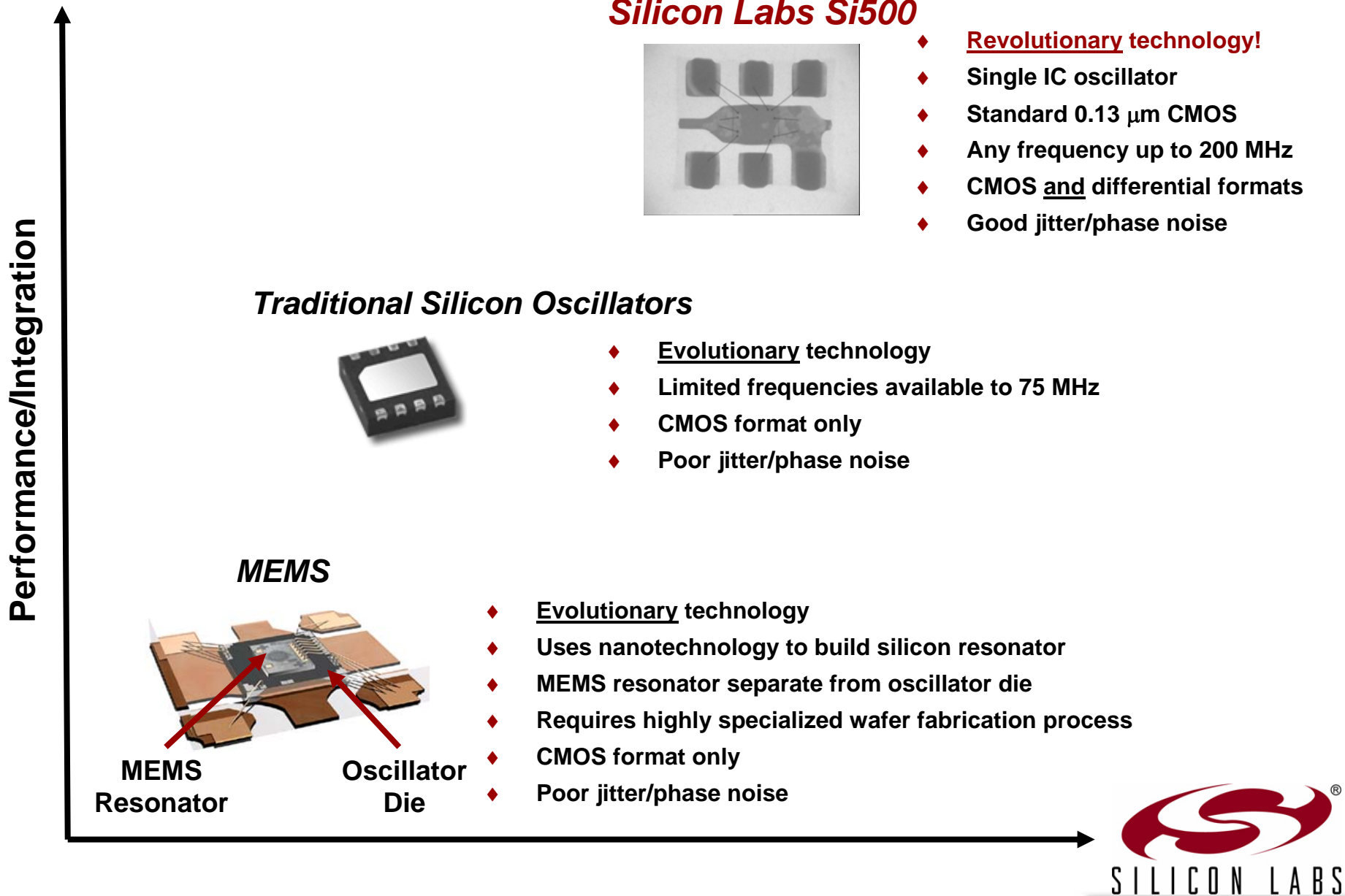

Si500 Silicon Oscillator (XLO)

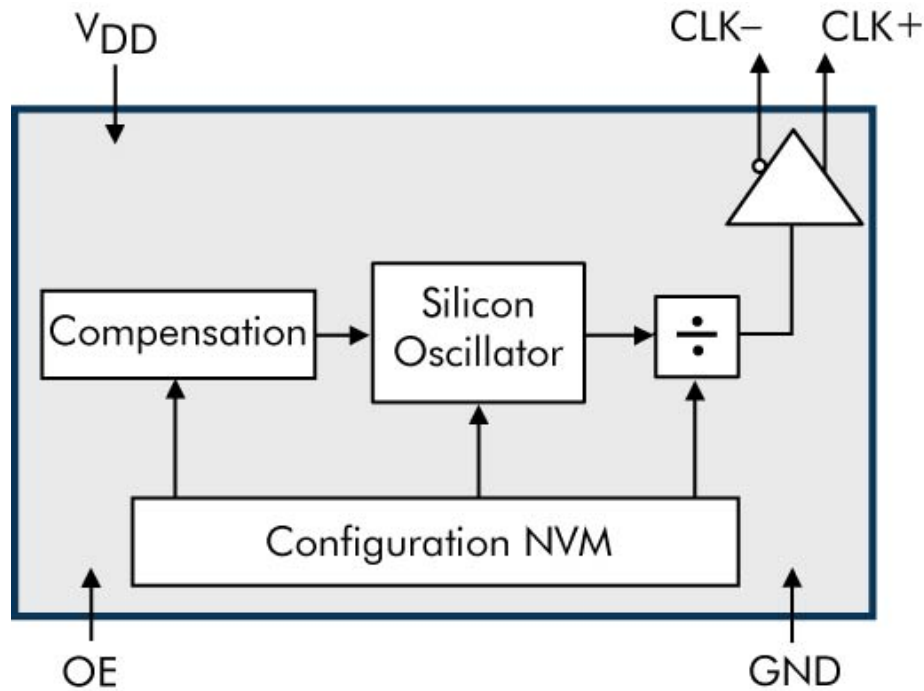

- ◆ Quartz-free, all silicon oscillator
- ◆ Generates any frequency from 0.9 to 200 MHz
- ◆ Low jitter: 1.5 ps RMS phase jitter, 2 ps RMS period jitter (max)
- ◆ Wide selection of output formats: CMOS, LVPECL, LVDS, HCSL, SSTL
- ◆ Dual output CMOS clock oscillators available: produces 2 clocks at same frequency
- ◆ Driver stopped, tristate, and powerdown options available on OE pin
- ◆ Footprint compatible with 3.2x5.0 mm layout
- ◆ Small package: 3.2x4.0 mm DFN
- ◆ 0 to +70 °C operating temperature range
- ◆ Low voltage operation: 3.3, 2.5 and 1.8 V
- ◆ Low core power: 8 mA

Immunity to Shock and Vibration Improves Reliability

Quartz XO

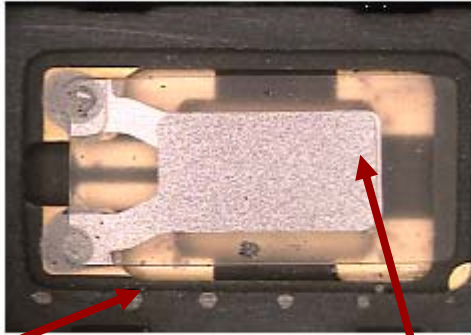

Hermetically Sealed Ceramic
or Metal Package

Crystal

- ◆ Relies on mechanical resonator for oscillation
- ◆ Sensitive to shock and vibration
- ◆ Requires hermetic assembly to prevent crystal contamination from affecting device performance

Silicon Labs Si500

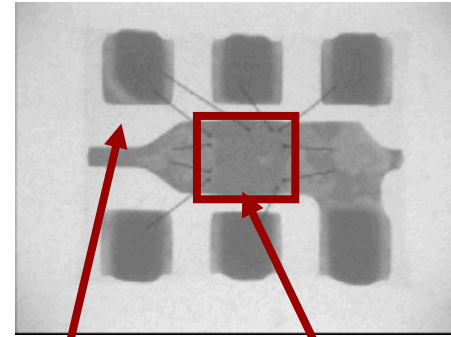

Plastic
Package

Silicon
Oscillator

- ◆ No moving parts
- ◆ Highly immune to shock and vibration
- ◆ Plastic IC packaging does not require hermetic seal, not susceptible to contamination
- ◆ Reliable startup and operation

High PSRR Simplifies Design

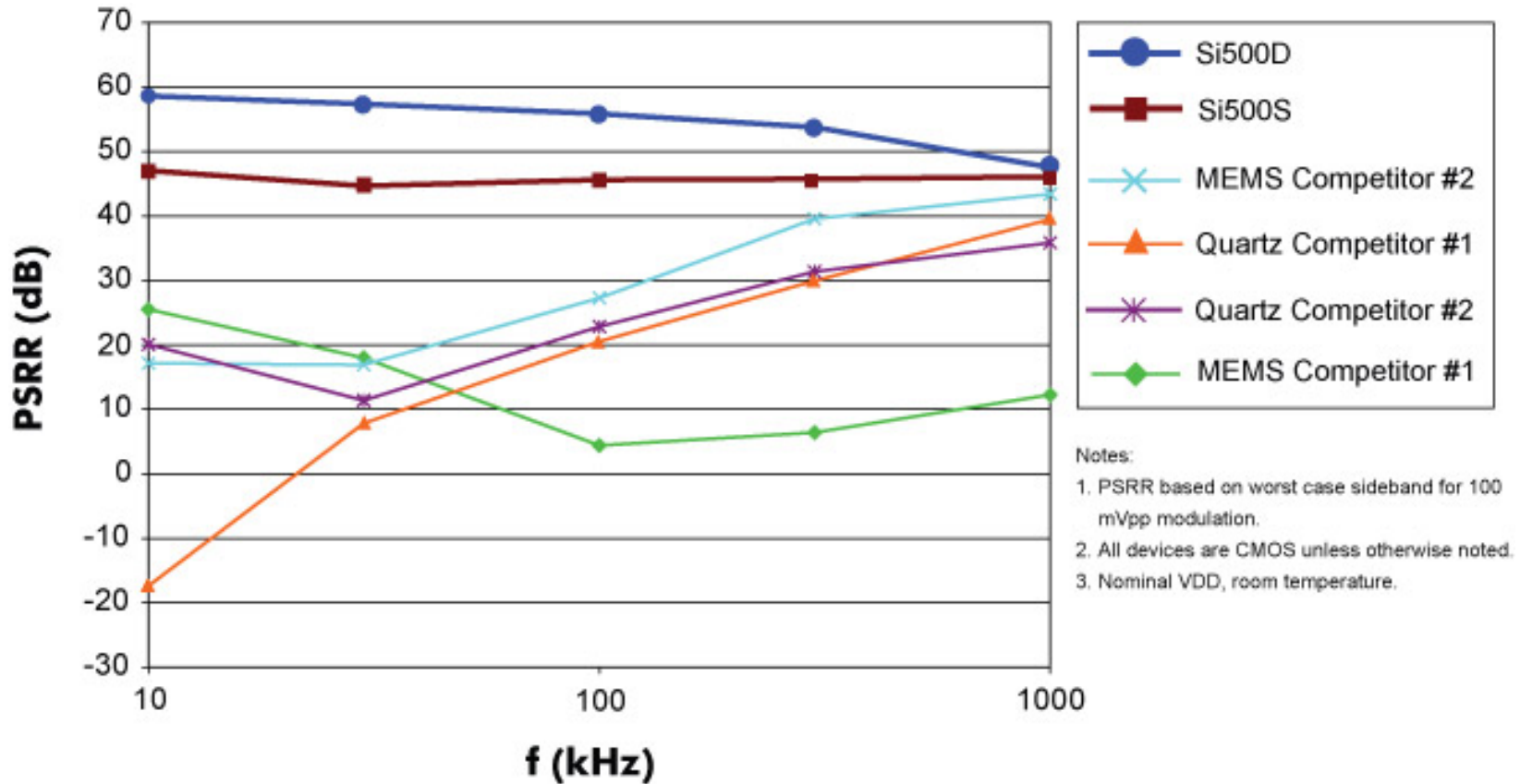

- ◆ Si500 provides bench-quality jitter performance in real-world applications
- ◆ Minimizes impact of power supply switching noise on system performance

Unmatched Performance and Reliability

Key Feature	Customer Benefits
100% CMOS silicon oscillator	Standard, high volume IC manufacturing flow Short, reliable lead times: <2 weeks for samples Quick turn factory programming for standard/custom frequencies
Any-rate frequency support from 0.9 to 200 MHz	Simplified component selection Design flexibility
Differential clock formats	Simplified component selection
High reliability	Excellent mechanical shock, vibration Fast, reliable startup (3 ms) Reliable long-term operation
Low jitter (0.9 ps rms period jitter)	Improves system performance Provides extra margin to simplify design
High PSRR	Simplifies design Reduces product development time
3.2x4 mm DFN packaging	Drop-in compatible with 3.2x5 mm XOs

Si500 Target Applications

Market	Application
Consumer	Digital still cameras, camcorders
Storage	Hard disk drives, servers
Computing	PCI Express peripherals
Imaging	LCD displays
Office Automation	Printers
Industrial	White goods, instrumentation, industrial control



Si500 Silicon Oscillator Selector Guide

Part #	Type	Package	Stability*	Output Format	Frequency (MHz)
Si500S	XO	3.2x4 mm 4 pad	±100 ±150	CMOS, SSTL	0.9 to 200
Si500D	XO	3.2x4 mm 6 pad	±100 ±150	LVPECL, LVDS, HCSL, dual output CMOS, diff CMOS, dual output SSTL, diff SSTL	0.9 to 200

* Inclusive of: initial frequency accuracy at 25 °C, operating temperature range, supply voltage change, output load change, 1st year aging at 25 °C, 260 °C reflow, shock and vibration

◆ Go to www.silabs.com/BuyXO to request part numbers



Easy to Use Tools and Documentation

- ◆ Product Documentation (www.silabs.com/timing)
 - Si500S and Si500D data sheets
 - EVB data sheet
 - AN409: *Output Clock Termination Guidelines*
- ◆ Part Number Utility
 - www.silabs.com/BuyXO
- ◆ Evaluation Boards
 - Si50x-32x4-EVB
 - Samples should be ordered separately
 - Contact factory applications for exceptions



Si50x-32x4-EVB

Summary

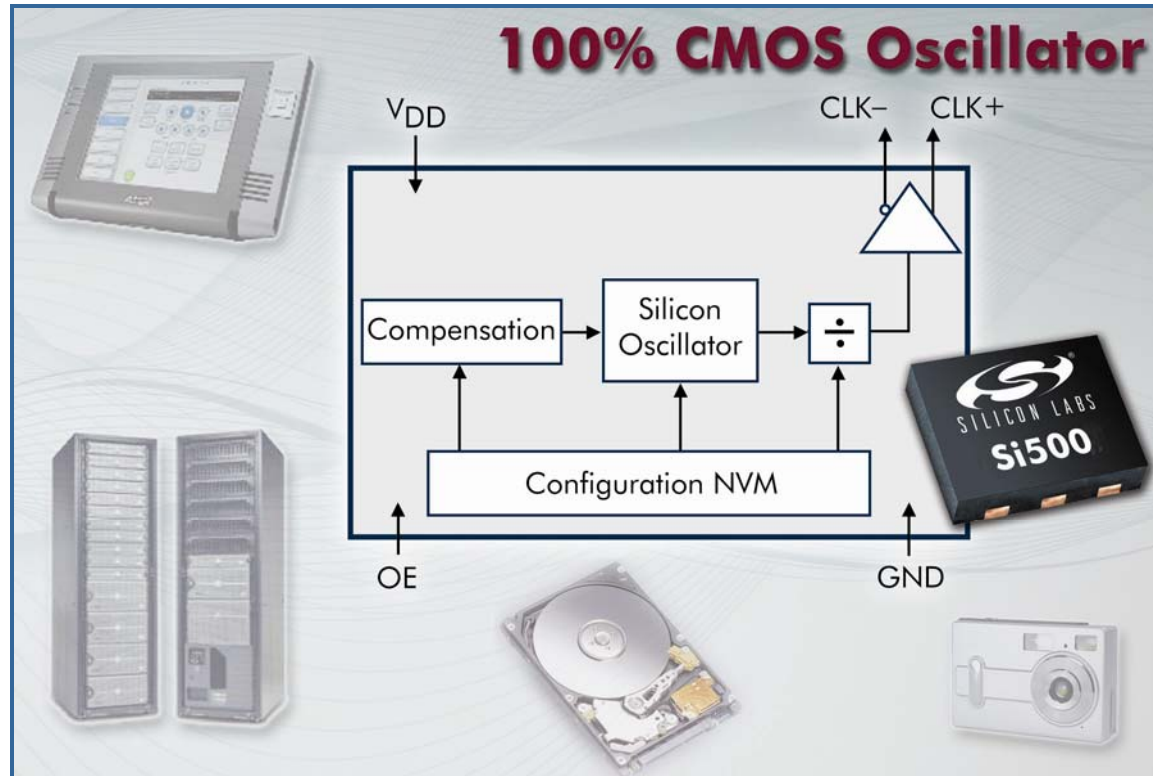

- ◆ Highest performance, all silicon oscillator enables replacement of quartz-based XO's
- ◆ CMOS-based architecture improves reliability and performance
- ◆ Si500 provides short, predictable lead times



S I L I C O N L A B S

www.silabs.com/Timing