

Open Carrier Double-Balanced Mixer For Microwave Telecommunications

Rev. V2

Features

- LO 4.5 TO 7.0 GHz
- RF 4.5 TO 7.0 GHz
- LO DC TO 2.0 GHz
- LO DRIVE +10 dBm (NOMINAL)
- MICROSTRIP INTERFACE

Description

The MC2410 is a double balanced mixer, designed for use in military, commercial and test equipment applications. The design utilizes Schottky ring quad diodes and broadband soft dielectric and ferrite baluns to attain excellent performance. This mixer can also be used as a phase detector and/or bi-phase modulator since the IF port is DC coupled to the diodes. The use of high temperature solder and welded assembly processes used internally makes it ideal for use in manual, semi-automated assembly. Environmental screening available to MIL-STD-883, MIL-STD-202, or MIL-DTL-28837, consult factory.

Product Image



Ordering Information

Part Number	Package
MC2410	Open Carrier
MC2410-2	Open Carrier

Electrical Specifications: $Z_0 = 50\Omega$ $Lo = +10$ dBm (Downconverter application only)

Parameter	Test Conditions	Units	Typical	Guaranteed	
				+25°C	-54° to +85°C
SSB Conversion Loss (max) & SSB Noise Figure (max)	fR = 4.5 to 7 GHz , fL = 4.5 to 7 GHz , fI = 0.01 to 1 GHz fR = 4.5 to 7 GHz , fL = 4.5 to 7 GHz , fI = 0.01 to 2 GHz	dB dB	5.2	6.5	7.0
			5.5	7.0	7.5
Isolation, L to R (min)	fL = 4.5 to 7 GHz	dB	24	20	18
Isolation, L to I (min)	fL = 4.5 to 7 GHz	dB	40	25	23
Isolation, R to I (min)	fL = 4.5 to 7 GHz	dB	20	10	8
1 dB Conversion Comp.	fL = +10 dBm	dBm	+3		
Input IP3	fR1 = 6 GHz at -10 dBm, fR2 = 6.01 GHz at -10 dBm, fL = 5 GHz at +10 dBm	dBm	+13		

1

ADVANCED: Data Sheets contain information regarding a product M/A-COM Technology Solutions is considering for development. Performance is based on target specifications, simulated results, and/or prototype measurements. Commitment to develop is not guaranteed.

PRELIMINARY: Data Sheets contain information regarding a product M/A-COM Technology Solutions has under development. Performance is based on engineering tests. Specifications are typical. Mechanical outline has been fixed. Engineering samples and/or test data may be available. Commitment to produce in volume is not guaranteed.

• **North America** Tel: 800.366.2266 • **Europe** Tel: +353.21.244.6400
• **India** Tel: +91.80.4155721 • **China** Tel: +86.21.2407.1588
Visit www.macomtech.com for additional data sheets and product information.

M/A-COM Technology Solutions Inc. and its affiliates reserve the right to make changes to the product(s) or information contained herein without notice.

Typical Performance Curves

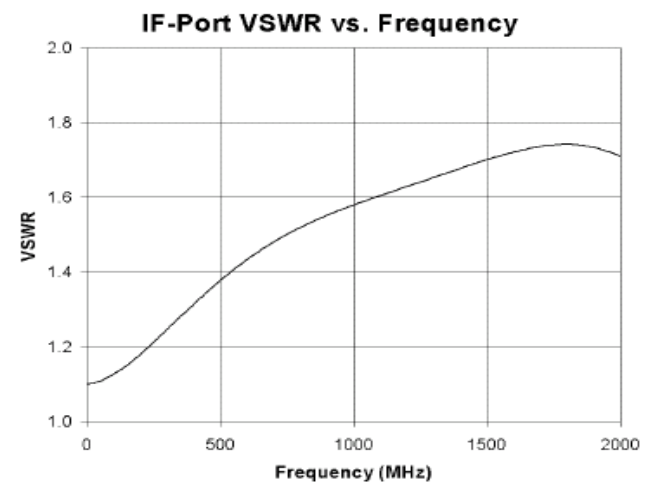
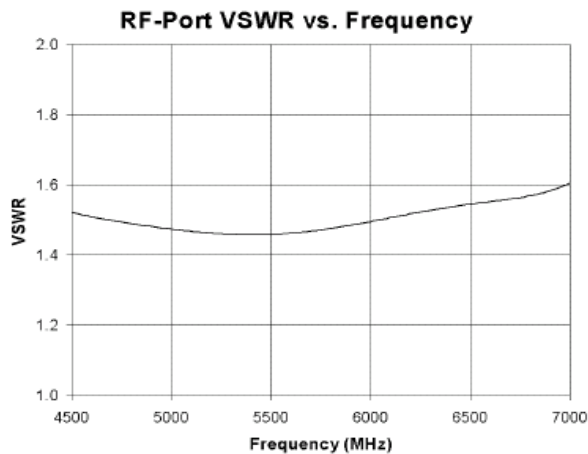
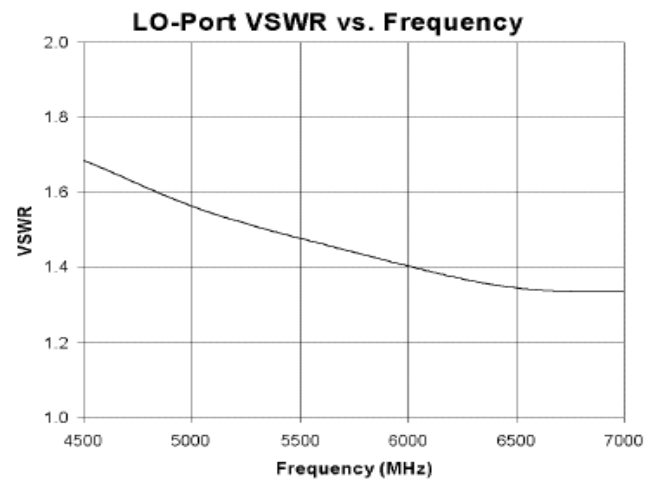
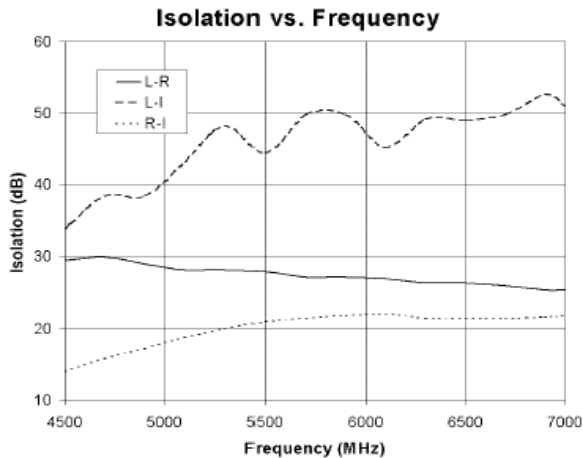
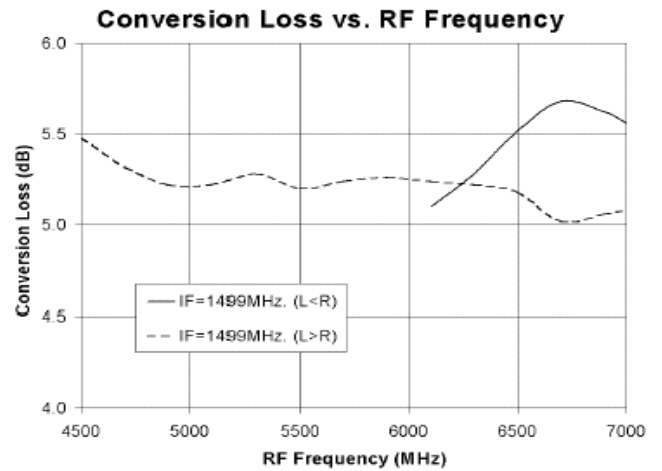
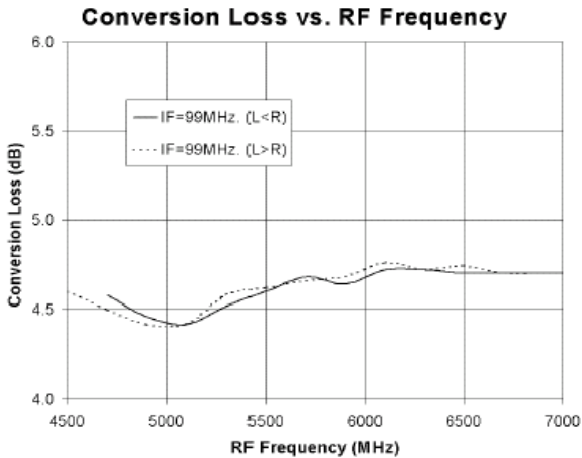

MC2410

Open Carrier Double-Balanced Mixer For Microwave Telecommunications

Rev. V2

Absolute Maximum Ratings

Parameter	Absolute Maximum
Operating Temperature	-54°C to +85°C
Storage Temperature	-65°C to +100°C
Peak Input Power	+23 dBm max @ +25°C +20 dBm max @ +85°C
Peak Input Current	50 mA DC

Outline Drawing: Open Carrier * MC2410

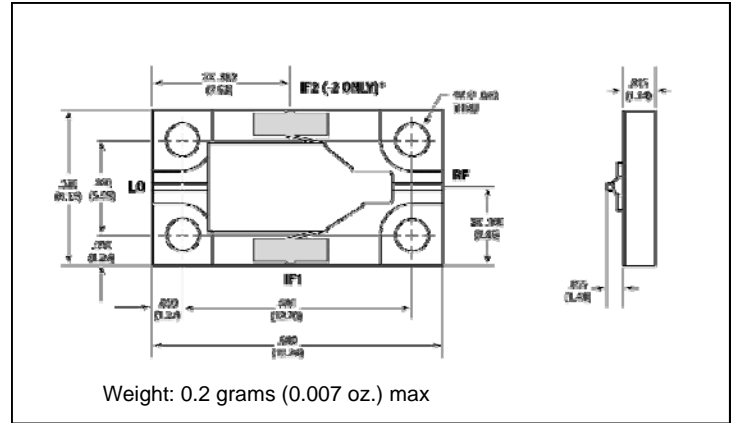

For base model, only the IF1 port is connected.
For the "-2" model, only the IF2 port is connected.

* Dimensions are inches (millimeters) ± 0.015 (0.38) unless otherwise specified.