



Shanghai Lunsure Electronic  
Technology Co.,Ltd  
Tel:0086-21-37185008  
Fax:0086-21-57152769

# SF21 THRU SF26

## Features

- High reliability
- High current capability
- Low forward voltage drop
- High surge capability

## Maximum Ratings

- Operating Temperature: -55°C to +125°C
- Storage Temperature: -55°C to +150°C
- For capacitive load, derate current by 20%

Part Number	Maximum Recurrent Peak Reverse Voltage	Maximum RMS Voltage	Maximum DC Blocking Voltage
SF21	50V	35V	50V
SF22	100V	70V	100V
SF23	150V	105V	150V
SF24	200V	140V	200V
SF25	300V	210V	300V
SF26	400V	280V	400V

**2.0 Amp Super Fast  
Rectifier  
50 to 400 Volts**

## DO-15

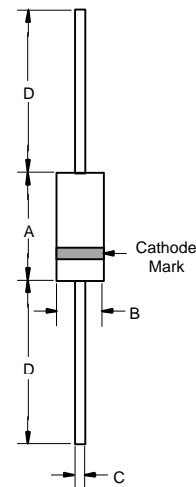

## Electrical Characteristics @ 25°C Unless Otherwise Specified

Average Forward Current	$I_{F(AV)}$	2.0A	$T_C = 55^\circ\text{C}$
Peak Forward Surge Current	$I_{FSM}$	50A	8.3ms, half sine
Maximum Instantaneous Forward Voltage SF21-SF24 SF25-SF26	$V_F$	0.95V 1.3V	$I_{FM} = 2.0\text{A};$ $T_C = 25^\circ\text{C}$
Maximum DC Reverse Current At Rated DC Blocking Voltage	$I_R$	5.0uA 100uA	$T_C = 25^\circ\text{C}$ $T_C = 100^\circ\text{C}$
Typical Junction Capacitance SF21-SF24 SF25-SF26	$C_J$	60pF 30pF	Measured at 1.0MHz, $V_R=4.0\text{V}$
Maximum Reverse Recovery Time	$T_{RR}$	35nS	$I_F=0.5\text{A}, I_R=1.0\text{A},$ $I_{RR}=0.25\text{A}$

Pulse Test: Pulse width 300 usec, Duty cycle 1%.

DIM	INCHES		MM		NOTE
	MIN	MAX	MIN	MAX	
A	.230	.300	5.80	7.60	
B	.104	.140	2.60	3.60	
C	.026	.034	.70	.90	
D	1.000	---	25.40	---	

# SF21 thru SF26

Figure 1  
Typical Reverse Characteristics

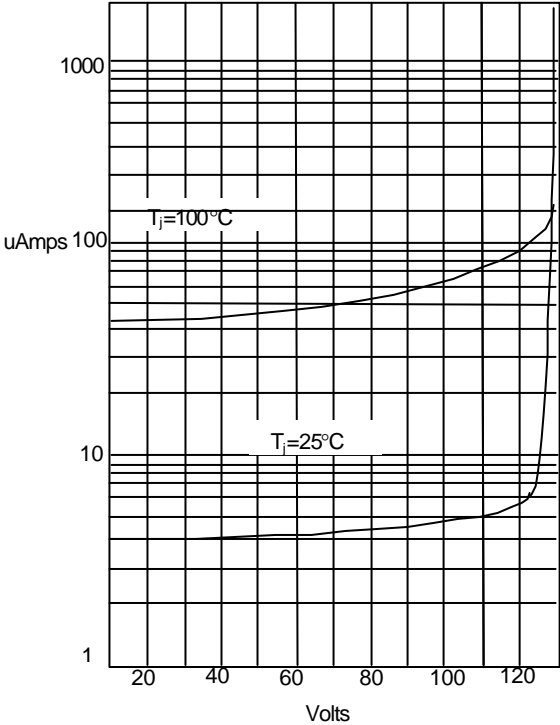

Instantaneous Reverse Current - uAmperes versus  
Percent of Rated Peak Reverse Voltage - %

Figure 2  
Typical Forward Characteristics

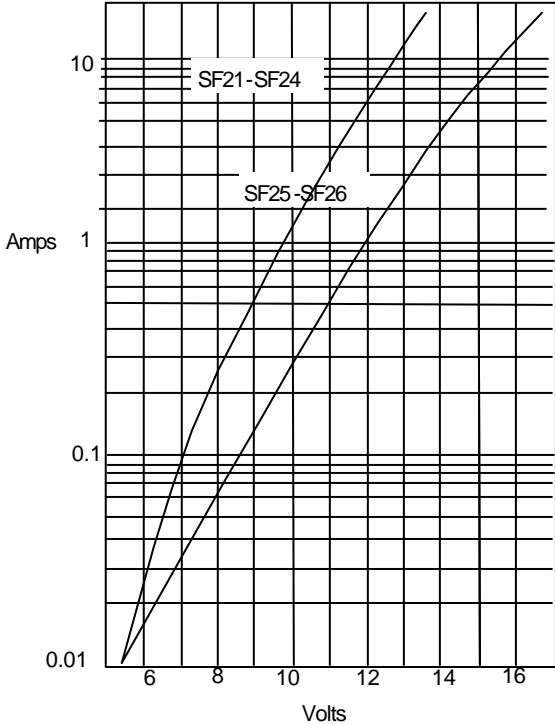

Instantaneous Forward Current - Amperes versus  
Instantaneous Forward Voltage - Volts

Figure 3  
Forward Derating Curve

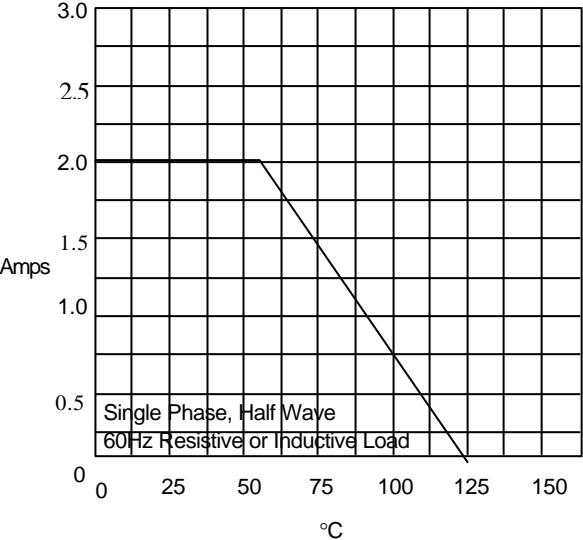

Average Forward Rectified Current Per Leg - Amperes versus  
Case Temperature - °C

# SF21 thru SF26

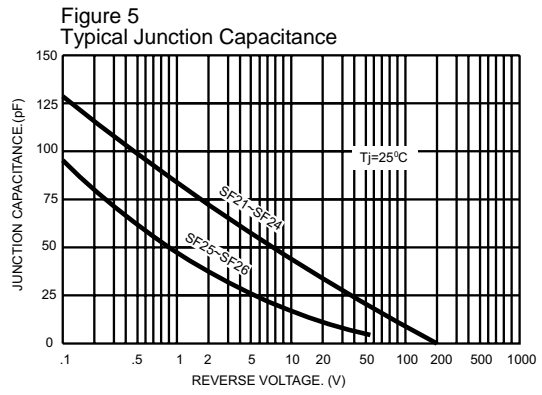
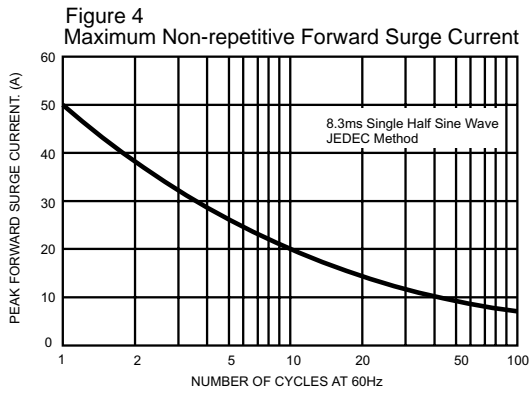

**Figure 6**  
Reverse Recovery Time Characteristic And Test Circuit Diagram

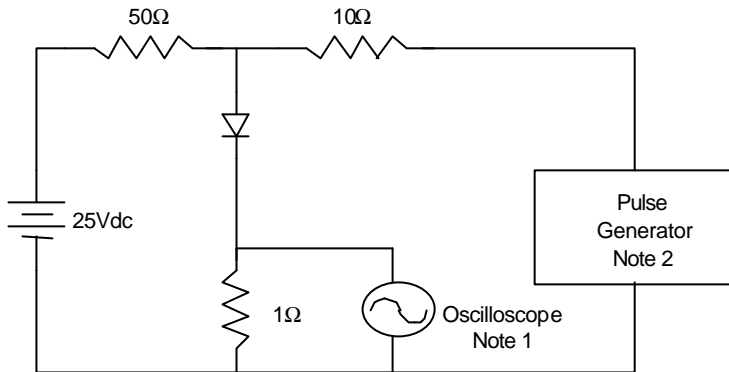

- Notes:
1. Rise Time = 7ns max.  
Input impedance = 1 megohm, 22pF
  2. Rise Time = 10ns max.  
Source impedance = 50 ohms
  3. Resistors are non-inductive

