

PBSS4160V

60 V, 1 A NPN low V_{CEsat} (BISS) transistor

Rev. 03 — 11 December 2009

Product data sheet

1. Product profile

1.1 General description

Low V_{CEsat} (BISS) NPN transistor in a SOT666 plastic package.

PNP complement: PBSS5160V.

1.2 Features

- Low collector-emitter saturation voltage V_{CEsat}
- High collector current capability I_C and I_{CM}
- High efficiency, reduces heat generation
- Reduces printed-circuit board area required
- Cost effective replacement for medium power transistor BCP55 and BCX55

1.3 Applications

- Major application segments:
 - ◆ Automotive
 - ◆ Telecom infrastructure
 - ◆ Industrial
- Power management:
 - ◆ DC-to-DC conversion
 - ◆ Supply line switching
- Peripheral driver:
 - ◆ Driver in low supply voltage applications (e.g. lamps and LEDs)
 - ◆ Inductive load driver (e.g. relays, buzzers and motors)

1.4 Quick reference data

Table 1. Quick reference data

Symbol	Parameter	Conditions	Min	Typ	Max	Unit
V_{CEO}	collector-emitter voltage	open base	-	-	60	V
I_C	collector current (DC)		[1]	-	1	A
I_{CM}	peak collector current	$t = 1$ ms or limited by $T_{j(max)}$	-	-	2	A
R_{CEsat}	equivalent on-resistance	$I_C = 1$ A; $I_B = 100$ mA	[2]	200	250	m Ω

[1] Device mounted on an FR4 Printed-Circuit Board (PCB), single-sided copper, tin-plated, 1 cm² collector mounting pad.

[2] Pulse test: $t_p \leq 300$ μ s; $\delta \leq 0.02$.

2. Pinning information

Table 2. Discrete pinning

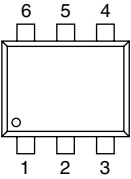
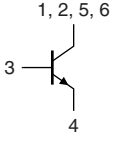
Pin	Description	Simplified outline	Symbol
1, 2, 5, 6	collector		 sym014
3	base		
4	emitter		

3. Ordering information

Table 3. Ordering information

Type number	Package		
	Name	Description	Version
PBSS4160V	-	plastic surface mounted package; 6 leads	SOT666

4. Marking

Table 4. Marking codes

Type number	Marking code
PBSS4160V	41

5. Limiting values

Table 5. Limiting values

In accordance with the Absolute Maximum Rating System (IEC 60134).

Symbol	Parameter	Conditions	Min	Max	Unit
V_{CBO}	collector-base voltage	open emitter	-	80	V
V_{CEO}	collector-emitter voltage	open base	-	60	V
V_{EBO}	emitter-base voltage	open collector	-	5	V
I_C	collector current (DC)		[1] -	0.9	A
			[2]	1	
I_{CM}	peak collector current	$t = 1$ ms or limited by $T_{j(max)}$	-	2	A
I_B	base current (DC)		-	300	mA
I_{BM}	peak base current	$t_p \leq 300$ μ s; $\delta \leq 0.02$	-	1	A
P_{tot}	total power dissipation	$T_{amb} \leq 25$ °C	[1] -	300	mW
			[2] -	500	mW
T_j	junction temperature		-	150	°C
T_{amb}	ambient temperature		-65	+150	°C
T_{stg}	storage temperature		-65	+150	°C

[1] Device mounted on an FR4 PCB, single-sided copper, tin-plated and standard footprint.

[2] Device mounted on an FR4 PCB, single-sided copper, tin-plated, 1 cm² collector mounting pad.

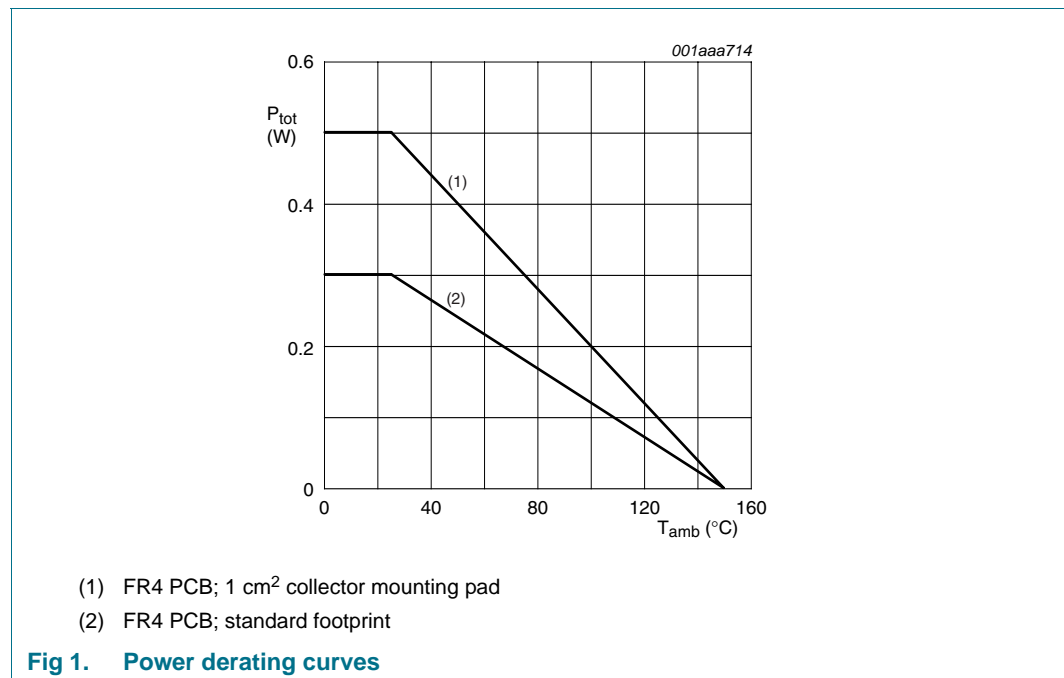

6. Thermal characteristics

Table 6. Thermal characteristics

Symbol	Parameter	Conditions	Min	Typ	Max	Unit
$R_{th(j-a)}$	thermal resistance from junction to ambient	in free air	[1]	-	-	415 K/W
			[2]	-	-	250 K/W

[1] Device mounted on an FR4 PCB, single-sided copper, tin-plated and standard footprint.

[2] Device mounted on an FR4 PCB, single-sided copper, tin-plated, 1 cm² collector mounting pad.

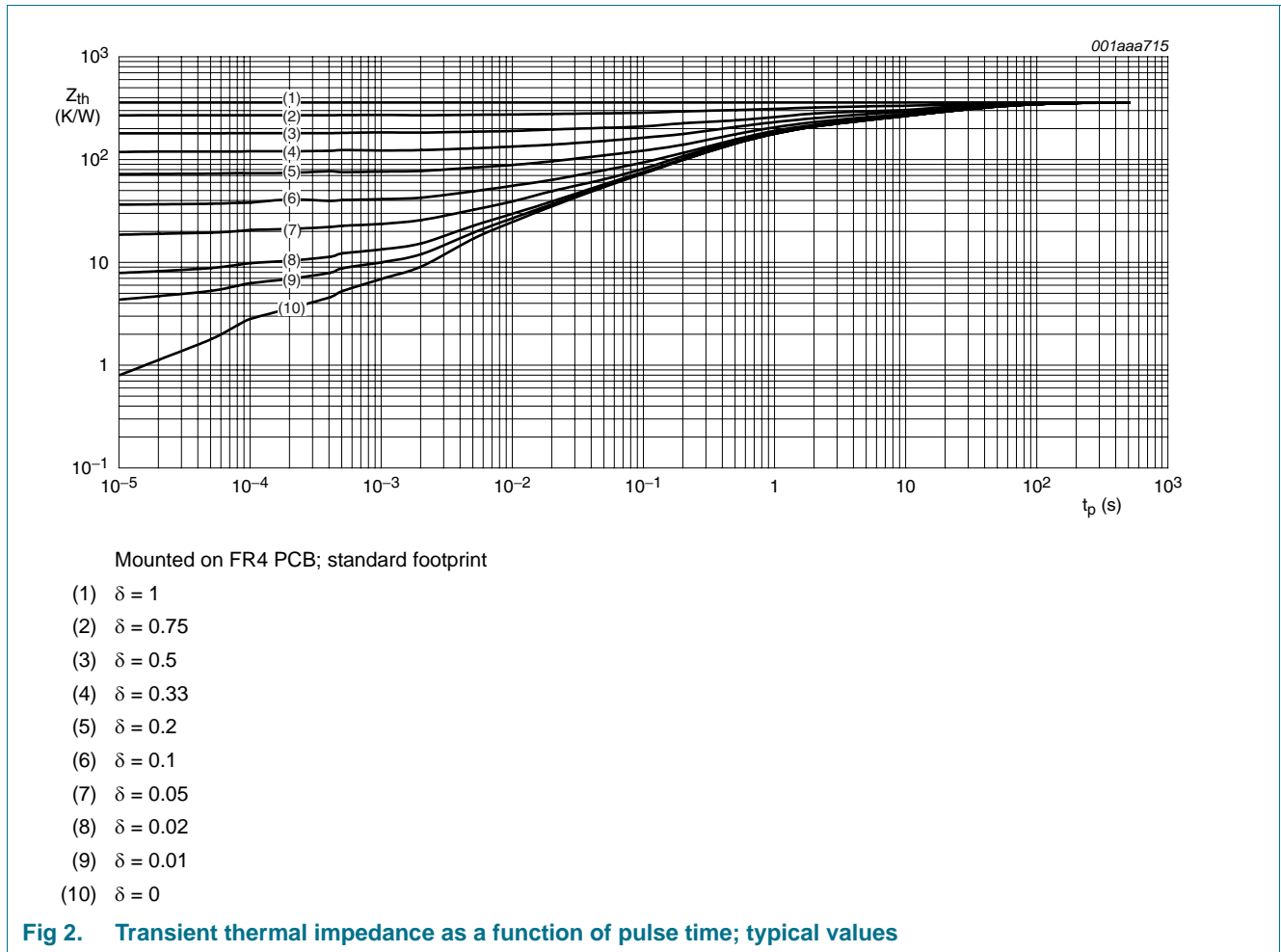

7. Characteristics

Table 7. Characteristics

$T_{amb} = 25\text{ °C}$ unless otherwise specified.

Symbol	Parameter	Conditions	Min	Typ	Max	Unit
I_{CBO}	collector-base cut-off current	$V_{CB} = 60\text{ V}; I_E = 0\text{ A}$	-	-	100	nA
		$V_{CB} = 60\text{ V}; I_E = 0\text{ A}; T_j = 150\text{ °C}$	-	-	50	μA
I_{CES}	collector-emitter cut-off current	$V_{CE} = 60\text{ V}; V_{BE} = 0\text{ V}$	-	-	100	nA
I_{EBO}	emitter-base cut-off current	$V_{EB} = 5\text{ V}; I_C = 0\text{ A}$	-	-	100	nA
h_{FE}	DC current gain	$V_{CE} = 5\text{ V}; I_C = 1\text{ mA}$	250	400	-	
		$V_{CE} = 5\text{ V}; I_C = 500\text{ mA}$	[1] 200	350	-	
		$V_{CE} = 5\text{ V}; I_C = 1\text{ A}$	[1] 100	150	-	
V_{CEsat}	collector-emitter saturation voltage	$I_C = 100\text{ mA}; I_B = 1\text{ mA}$	-	90	110	mV
		$I_C = 500\text{ mA}; I_B = 50\text{ mA}$	-	110	140	mV
		$I_C = 1\text{ A}; I_B = 100\text{ mA}$	[1] -	200	250	mV
V_{BEsat}	base-emitter saturation voltage	$I_C = 1\text{ A}; I_B = 50\text{ mA}$	-	0.95	1.1	V
R_{CEsat}	equivalent on-resistance	$I_C = 1\text{ A}; I_B = 100\text{ mA}$	[1] -	200	250	$\text{m}\Omega$
V_{BEon}	base-emitter turn-on voltage	$V_{CE} = 5\text{ V}; I_C = 1\text{ A}$	-	0.82	0.9	V
t_d	delay time	$V_{CC} = 10\text{ V}; I_C = 0.5\text{ A}; I_{Bon} = 25\text{ mA}; I_{Boff} = -25\text{ mA}$	-	11	-	ns
t_r	rise time		-	78	-	ns
t_{on}	turn-on time		-	90	-	ns
t_s	storage time		-	340	-	ns
t_f	fall time		-	160	-	ns
t_{off}	turn-off time		-	500	-	ns
f_T	transition frequency		$I_C = 50\text{ mA}; V_{CE} = 10\text{ V}; f = 100\text{ MHz}$	150	220	-
C_c	collector capacitance	$V_{CB} = 10\text{ V}; I_E = I_e = 0\text{ A}; f = 1\text{ MHz}$	-	5.5	10	pF

[1] Pulse test: $t_p \leq 300\text{ }\mu\text{s}; \delta \leq 0.02$.

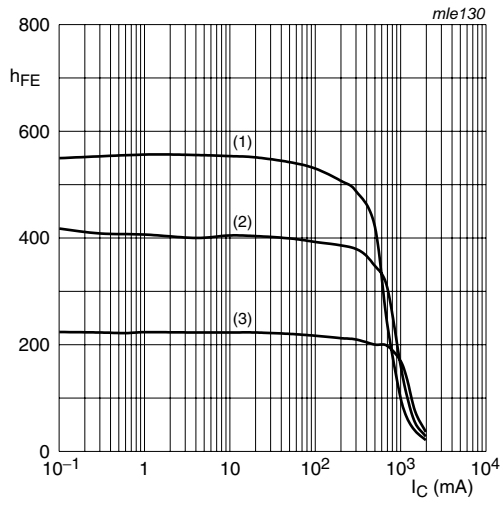

$V_{CE} = 5\text{ V}$
 (1) $T_{amb} = 100\text{ °C}$
 (2) $T_{amb} = 25\text{ °C}$
 (3) $T_{amb} = -55\text{ °C}$

Fig 3. DC current gain as a function of collector current; typical values

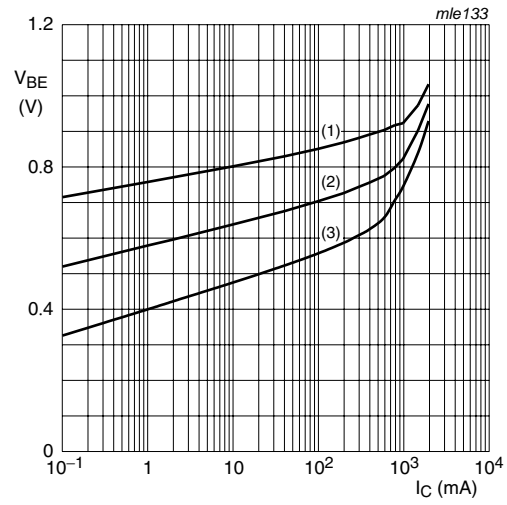

$V_{CE} = 5\text{ V}$
 (1) $T_{amb} = -55\text{ °C}$
 (2) $T_{amb} = 25\text{ °C}$
 (3) $T_{amb} = 100\text{ °C}$

Fig 4. Base-emitter voltage as a function of collector current; typical values

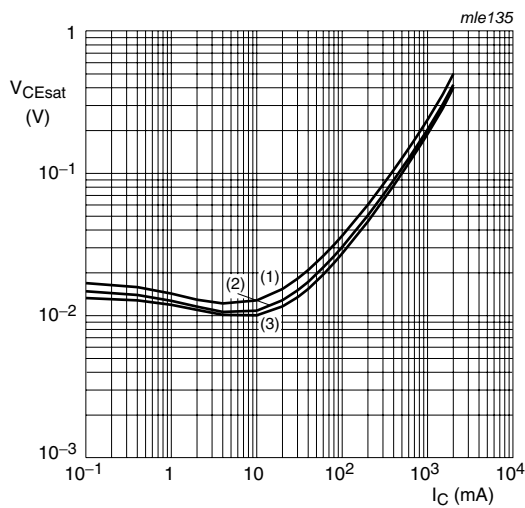

$I_C/I_B = 10$
 (1) $T_{amb} = 100\text{ °C}$
 (2) $T_{amb} = 25\text{ °C}$
 (3) $T_{amb} = -55\text{ °C}$

Fig 5. Collector-emitter saturation voltage as a function of collector current; typical values

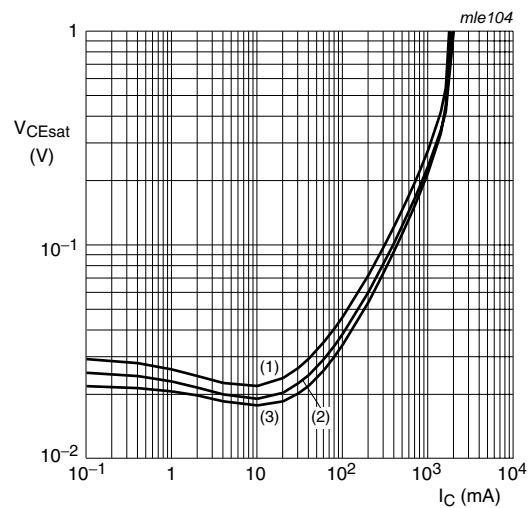

$I_C/I_B = 20$
 (1) $T_{amb} = 100\text{ °C}$
 (2) $T_{amb} = 25\text{ °C}$
 (3) $T_{amb} = -55\text{ °C}$

Fig 6. Collector-emitter saturation voltage as a function of collector current; typical values

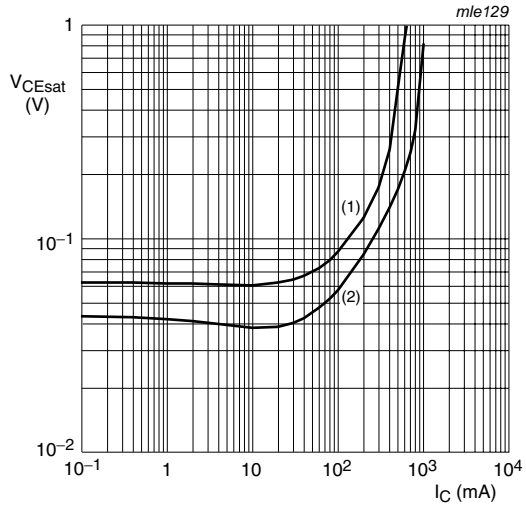

$T_{amb} = 25\text{ }^{\circ}\text{C}$
 (1) $I_C/I_B = 100$
 (2) $I_C/I_B = 50$

Fig 7. Collector-emitter saturation voltage as a function of collector current; typical values

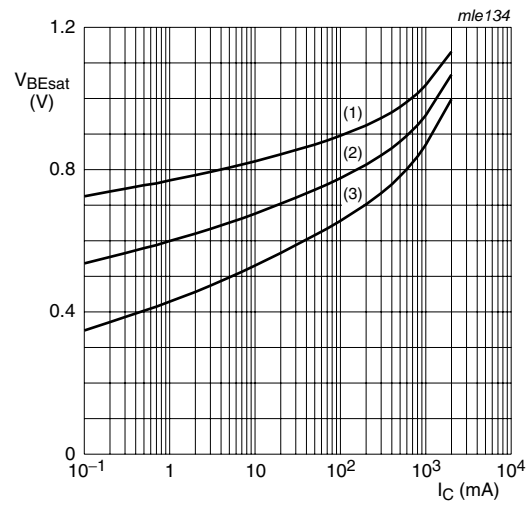

$I_C/I_B = 20$
 (1) $T_{amb} = -55\text{ }^{\circ}\text{C}$
 (2) $T_{amb} = 25\text{ }^{\circ}\text{C}$
 (3) $T_{amb} = 100\text{ }^{\circ}\text{C}$

Fig 8. Base-emitter saturation voltage as a function of collector current; typical values

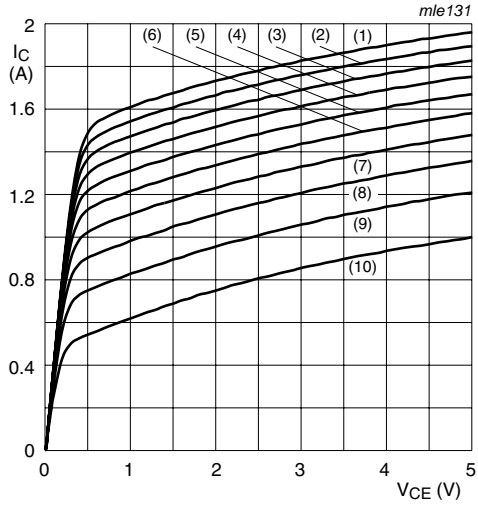

- $T_{amb} = 25\text{ }^\circ\text{C}$
- (1) $I_B = 60\text{ mA}$
 - (2) $I_B = 54\text{ mA}$
 - (3) $I_B = 48\text{ mA}$
 - (4) $I_B = 42\text{ mA}$
 - (5) $I_B = 36\text{ mA}$
 - (6) $I_B = 30\text{ mA}$
 - (7) $I_B = 24\text{ mA}$
 - (8) $I_B = 18\text{ mA}$
 - (9) $I_B = 12\text{ mA}$
 - (10) $I_B = 6\text{ mA}$

Fig 9. Collector current as a function of collector-emitter voltage; typical values

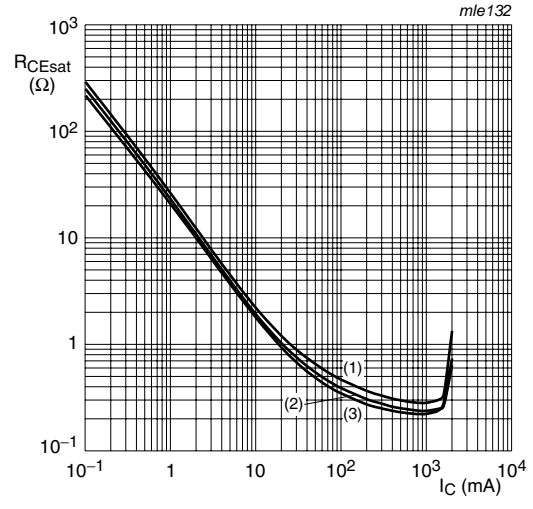

- $I_C/I_B = 20$
- (1) $T_{amb} = 100\text{ }^\circ\text{C}$
 - (2) $T_{amb} = 25\text{ }^\circ\text{C}$
 - (3) $T_{amb} = -55\text{ }^\circ\text{C}$

Fig 10. Equivalent on-resistance as a function of collector current; typical values

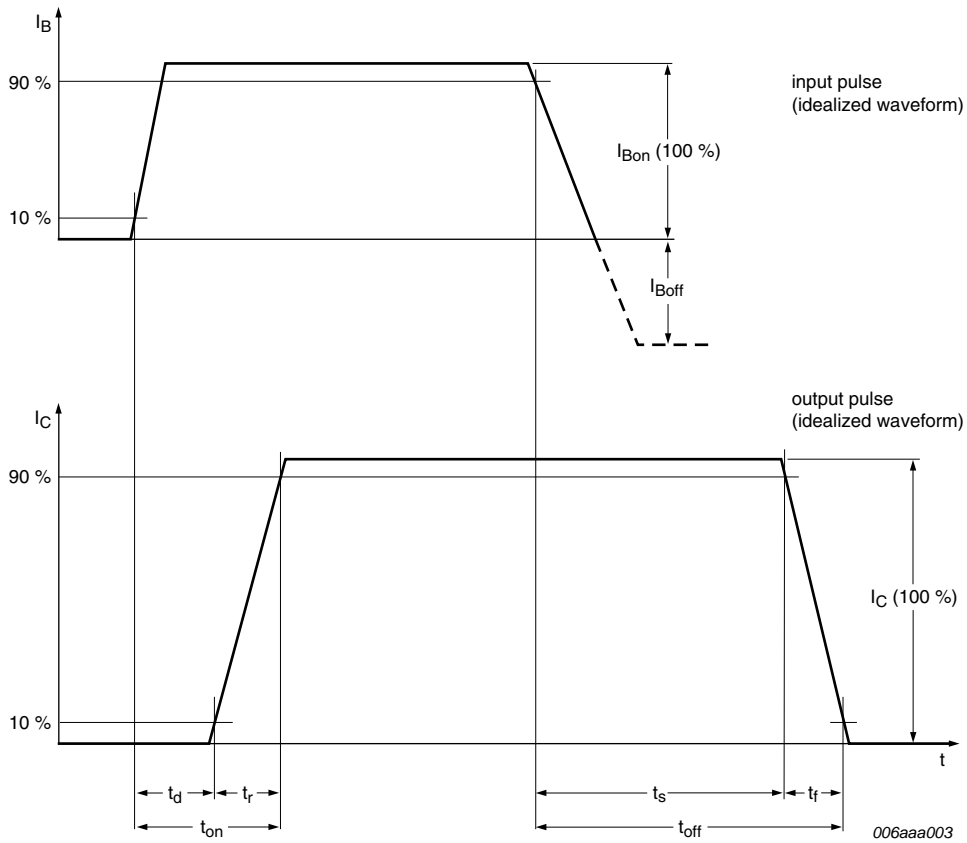
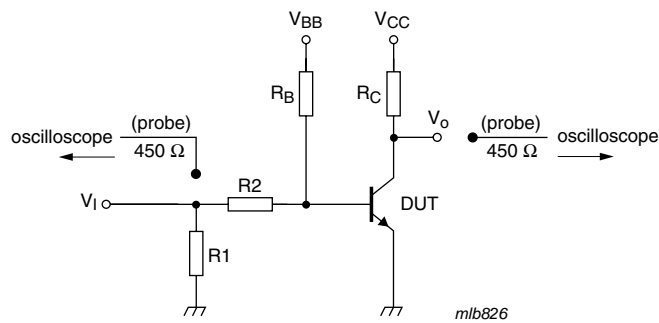

Fig 11. BISS transistor switching time definition



$V_{CC} = 10\text{ V}$; $I_C = 0.5\text{ A}$; $I_{Bon} = 25\text{ mA}$; $I_{Boff} = -25\text{ mA}$

Fig 12. Test circuit for switching times

8. Package outline

Plastic surface-mounted package; 6 leads

SOT666

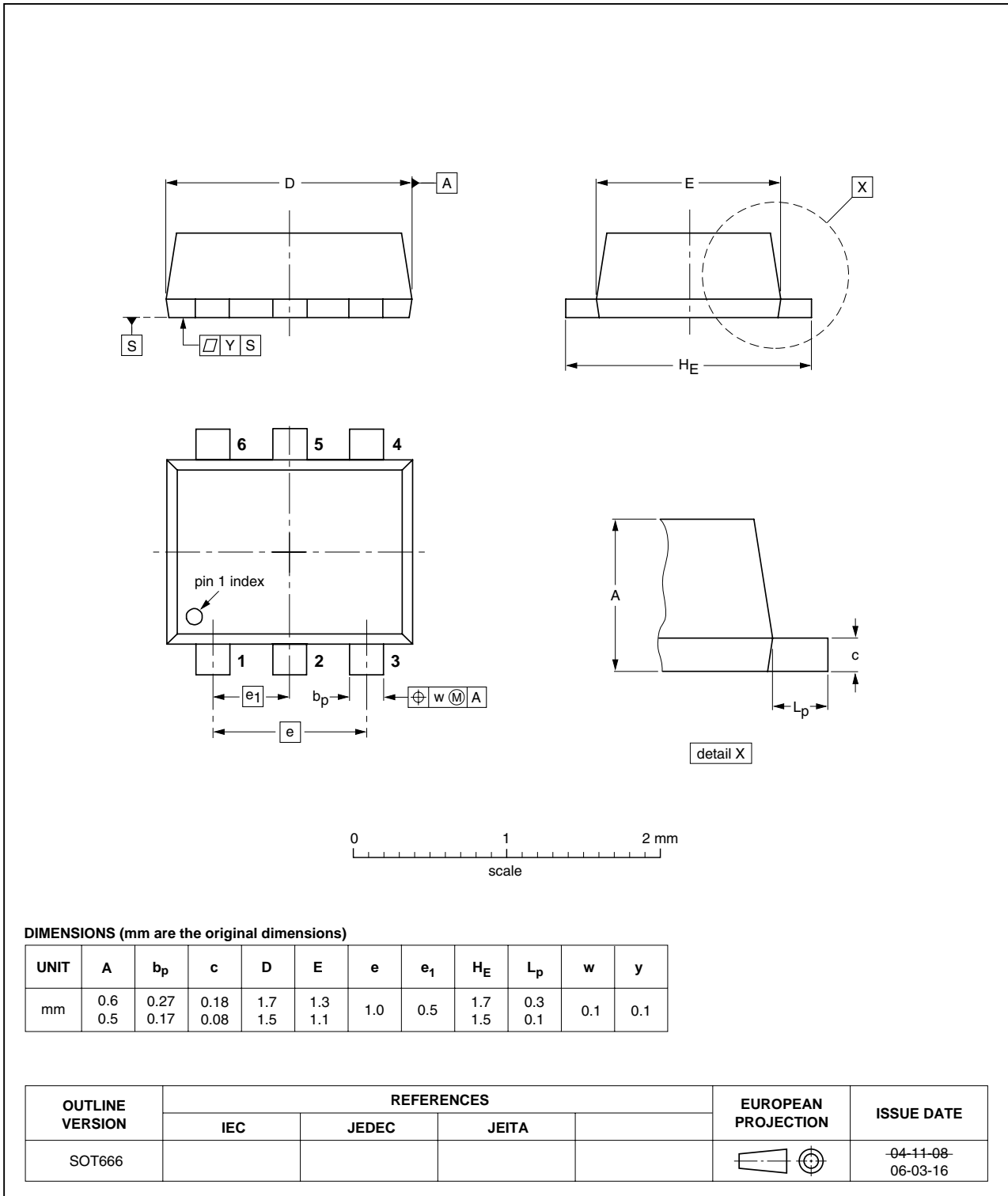

Fig 13. Package outline SOT666

9. Packing information

Table 8. Packing methods

The indicated -xxx are the last three digits of the 12NC ordering code.^[1]

Type number	Package	Description	Packing quantity
			4000
PBSS4160V	SOT666	4 mm pitch, 8 mm tape and reel	-115

[1] For further information and the availability of packing methods, see [Section 12](#).

10. Revision history

Table 9. Revision history

Document ID	Release date	Data sheet status	Change notice	Supersedes
PBSS4160V_3	20091211	Product data sheet	-	PBSS4160V_2
Modifications:		<ul style="list-style-type: none">• This data sheet was changed to reflect the new company name NXP Semiconductors, including new legal definitions and disclaimers. No changes were made to the technical content.• Table 2 “Discrete pinning”: updated• Figure 13 “Package outline SOT666”: updated		
PBSS4160V_2	20050131	Product data sheet	-	PBSS4160V_1
PBSS4160V_1	20040423	Objective data sheet	-	-

11. Legal information

11.1 Data sheet status

Document status ^{[1][2]}	Product status ^[3]	Definition
Objective [short] data sheet	Development	This document contains data from the objective specification for product development.
Preliminary [short] data sheet	Qualification	This document contains data from the preliminary specification.
Product [short] data sheet	Production	This document contains the product specification.

[1] Please consult the most recently issued document before initiating or completing a design.

[2] The term 'short data sheet' is explained in section "Definitions".

[3] The product status of device(s) described in this document may have changed since this document was published and may differ in case of multiple devices. The latest product status information is available on the Internet at URL <http://www.nxp.com>.

11.2 Definitions

Draft — The document is a draft version only. The content is still under internal review and subject to formal approval, which may result in modifications or additions. NXP Semiconductors does not give any representations or warranties as to the accuracy or completeness of information included herein and shall have no liability for the consequences of use of such information.

Short data sheet — A short data sheet is an extract from a full data sheet with the same product type number(s) and title. A short data sheet is intended for quick reference only and should not be relied upon to contain detailed and full information. For detailed and full information see the relevant full data sheet, which is available on request via the local NXP Semiconductors sales office. In case of any inconsistency or conflict with the short data sheet, the full data sheet shall prevail.

11.3 Disclaimers

General — Information in this document is believed to be accurate and reliable. However, NXP Semiconductors does not give any representations or warranties, expressed or implied, as to the accuracy or completeness of such information and shall have no liability for the consequences of use of such information.

Right to make changes — NXP Semiconductors reserves the right to make changes to information published in this document, including without limitation specifications and product descriptions, at any time and without notice. This document supersedes and replaces all information supplied prior to the publication hereof.

Suitability for use — NXP Semiconductors products are not designed, authorized or warranted to be suitable for use in medical, military, aircraft, space or life support equipment, nor in applications where failure or malfunction of an NXP Semiconductors product can reasonably be expected to result in personal injury, death or severe property or environmental

damage. NXP Semiconductors accepts no liability for inclusion and/or use of NXP Semiconductors products in such equipment or applications and therefore such inclusion and/or use is at the customer's own risk.

Applications — Applications that are described herein for any of these products are for illustrative purposes only. NXP Semiconductors makes no representation or warranty that such applications will be suitable for the specified use without further testing or modification.

Limiting values — Stress above one or more limiting values (as defined in the Absolute Maximum Ratings System of IEC 60134) may cause permanent damage to the device. Limiting values are stress ratings only and operation of the device at these or any other conditions above those given in the Characteristics sections of this document is not implied. Exposure to limiting values for extended periods may affect device reliability.

Terms and conditions of sale — NXP Semiconductors products are sold subject to the general terms and conditions of commercial sale, as published at <http://www.nxp.com/profile/terms>, including those pertaining to warranty, intellectual property rights infringement and limitation of liability, unless explicitly otherwise agreed to in writing by NXP Semiconductors. In case of any inconsistency or conflict between information in this document and such terms and conditions, the latter will prevail.

No offer to sell or license — Nothing in this document may be interpreted or construed as an offer to sell products that is open for acceptance or the grant, conveyance or implication of any license under any copyrights, patents or other industrial or intellectual property rights.

Export control — This document as well as the item(s) described herein may be subject to export control regulations. Export might require a prior authorization from national authorities.

Quick reference data — The Quick reference data is an extract of the product data given in the Limiting values and Characteristics sections of this document, and as such is not complete, exhaustive or legally binding.

11.4 Trademarks

Notice: All referenced brands, product names, service names and trademarks are the property of their respective owners.

12. Contact information

For more information, please visit: <http://www.nxp.com>

For sales office addresses, please send an email to: salesaddresses@nxp.com

13. Contents

1	Product profile	1
1.1	General description	1
1.2	Features	1
1.3	Applications	1
1.4	Quick reference data	1
2	Pinning information	2
3	Ordering information	2
4	Marking	2
5	Limiting values	3
6	Thermal characteristics	4
7	Characteristics	5
8	Package outline	10
9	Packing information	11
10	Revision history	12
11	Legal information	13
11.1	Data sheet status	13
11.2	Definitions	13
11.3	Disclaimers	13
11.4	Trademarks	13
12	Contact information	13
13	Contents	14

Please be aware that important notices concerning this document and the product(s) described herein, have been included in section 'Legal information'.



© NXP B.V. 2009.

All rights reserved.

For more information, please visit: <http://www.nxp.com>

For sales office addresses, please send an email to: salesaddresses@nxp.com

Date of release: 11 December 2009

Document identifier: PBSS4160V_3