

Specification LX110 . LX113

All exposed cast aluminum components are made of non corrosive pure aluminum copper free (Aluminum is less than .1% copper content.#356 alloy.)
 Finish: All polyester powder baked coatings preceded with a 5 baths preparation process. Meets military grade MIL-C781706 with a 2000 hours salt spray test.

- Pulse rated medium base porcelain socket.
- 75W/600V thermoplastic compact fluorescent socket.
- One-piece molded silicone gasket with memory retention.
- High power factor CWA ballast. Or 98% P.F.electronic smart ballast with end of life detection for compact fluorescent.
- All stainless steel hardware.
- All Moving and removable parts are sealed with a memory retention silicone gasket.
- Cast aluminum swing out hinge mechanism for quick maintenance access.

- 1 - Galvanized mounting plate with perimeter gasketing .
- 2 - Cast aluminum isolated ballast compartment
- 3 - One piece copper free cast aluminum pyramid housing available with closed or open luminous faces.
- 4 - Standard specular multi facet reflector,with type V distribution.
- 5 - Tempered frosted glass for luminous faces.
- 6 - Hinge frame slider allowing to keep the luminaire lens frame in open position during maintenance.
- 7 - Clear tempered glass lens.
- 8 - Stainless steel captive hexagonal cap screws .
- 9 - Cast aluminum sealed removable regressed glass frame, with perimeter memory retention embedded silicone gasket.

LX110: Enclosed pyramid housing down light.
LX113: Open light glow triangular openings with down light.

Photometry

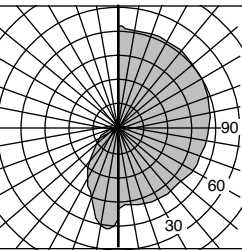

Separate updated technical specification sheets with related models and light sources with I.E.S formatted photometry are available on www.luminis.com.

For options details and specifications, please refer to pages 42 & 72

Certification Mounting

UL. Wet Location. Max.weight: 30 lbs.
 Installation: Mounts over a standard 4" octagonal electrical box with 3 1/2" c/c mounting holes. (by others) additional separate mounting holes are provided with wall plate.

Model#	Light source selection	Voltage	Finish	Options	
<input type="checkbox"/> LX110 <input type="checkbox"/> LX113	MH (ED17) <input type="checkbox"/> M70 <input type="checkbox"/> M100 <input type="checkbox"/> M150 <input type="checkbox"/> M175 HPS (ED17) <input type="checkbox"/> H70 <input type="checkbox"/> H100 <input type="checkbox"/> H150	CF (Gx24q) Single lamp <input type="checkbox"/> F142 <input type="checkbox"/> F157 <input type="checkbox"/> F170 CF (Gx24q) Two lamp <input type="checkbox"/> F226 <input type="checkbox"/> F232 <input type="checkbox"/> F242	120 V Standard factory prewired (If no voltage is specified) For other voltages, please specify with catalog number. H.I.D. <input type="checkbox"/> 208 V <input type="checkbox"/> 240 V <input type="checkbox"/> 277 V <input type="checkbox"/> 347 V COMP. FLUO. Smart ballast 120/277 <input type="checkbox"/> 347 V (To specify)	(Refer to color chart) Standard selection <input type="checkbox"/> WHT: Snow white <input type="checkbox"/> BKT: Jet black <input type="checkbox"/> BZT: Bronze <input type="checkbox"/> GRT: Titanium gray <input type="checkbox"/> DGT: Gun metal <input type="checkbox"/> CHT: Champagne <input type="checkbox"/> MST: Matte silver <input type="checkbox"/> GNT: Forest green Optional colors <input type="checkbox"/> CS: Custom color <input type="checkbox"/> RAL: RAL# color	Accessories <input type="checkbox"/> RL3: Type III semi specular reflector. (Single lamps only.) <input type="checkbox"/> RL4: Forward Throw type IV distribution RL3 & RL4 are available with LX110 only. Electrical <input type="checkbox"/> FS: Fuse <input type="checkbox"/> PH1: 120/277V photo cell <input type="checkbox"/> PH2: 347V photo cell <input type="checkbox"/> EM42S: 1 lamp (26/32/42W) EM battery. Note: EM optional battery test switch and pilot lamp are installed remotely. (Refer to page 72)
	Best results with H.I.D. Clear lamps (Lamps by others)				

luminaires may be altered for design improvements or discontinued without prior notice.

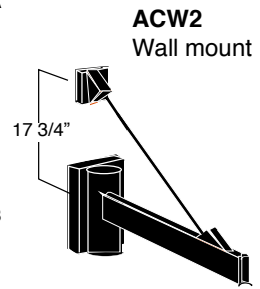
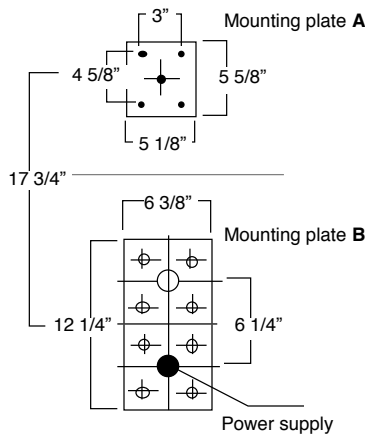
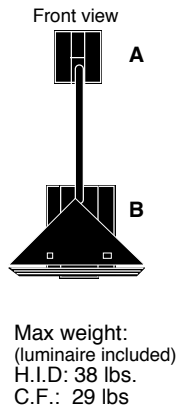
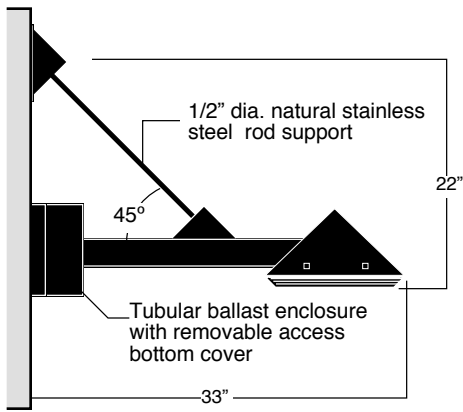

LX120-ACW2 Compact fluorescent
LX124-ACW2 H.I.D

Extruded aluminum wall mounted adaptor . 5" dia.x 12 3/4" lg. tubular ballast enclosure with removable cover for access to ballast tray. Cast aluminum wall mounted plate. 1/2" dia.stainless steel rod support. Extruded arm and all other parts are painted same color as luminaire .

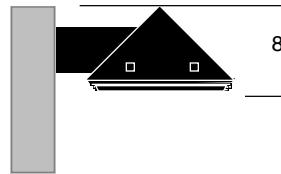
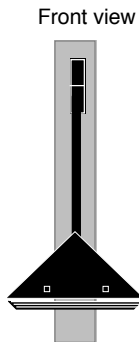
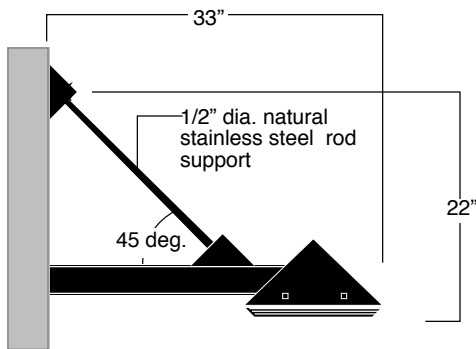

LX150-PC Compact fluorescent
LX150-PH H.I.D

E.P.A.: .74
 Extruded aluminum side pole mounting adaptor. 2" X 4" Extruded arm and all other parts are painted same color as luminaire..

LX120-ACA2 Compact fluorescent
LX124-ACA2 H.I.D

E.P.A.: 2.0
 Extruded aluminum side pole mounting adaptor. 1/2" dia. stainless steel natural rod support. Extruded arm and all other parts are painted same color as luminaire.

* Note: 36" extension with ACA2 attachment
 24" extension with LX150PC / LX150PH attachment

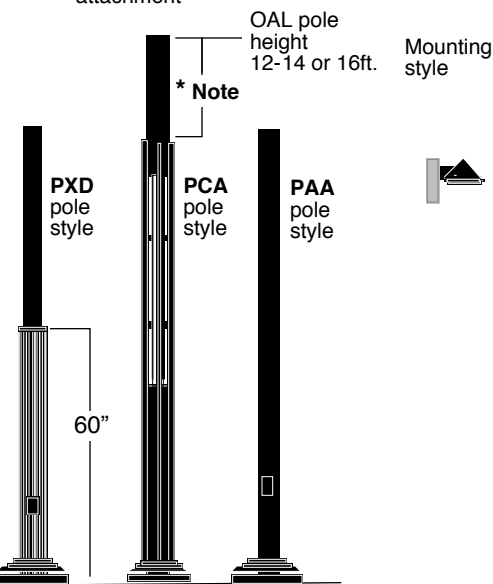

Post side mount for LX150PC
 (For Luxor Compact Fluorescent.)

4"O.D.	5"O.D.	4"O.D.	4"O.D.
PAA410-APC	PAA510-APC		PXD10-APC
PAA412-APC	PAA512-APC	PCA12-APC	PXD12-APC
PAA414-APC	PAA514-APC	PCA14-APC	PXD14-APC
PAA416-APC	PAA516-APC	PCA16-APC	PXD16-APC
PAA418-APC	PAA518-APC		PXD18-APC
PAA420-APC	PAA520-APC		PXD20-APC

Post side mount for LX150PH
 (For Luxor HID.)

5"O.D.	Pole height
PAA510-APC	10 ft
PAA512-APC	12 ft
PAA514-APC	14 ft
PAA516-APC	16 ft
PAA518-APC	18 ft
PAA520-APC	20 ft

Post side mount with ACA2 attachment accessory

Post top mounting for LX120-ACA2 and LX124-ACA2



PAA514-ACA	14 ft
PAA516-ACA	16 ft
PAA518-ACA	18 ft
PAA520-ACA	20 ft

For poles details and specification, please refer to pages 140 to 144

luminaires may be altered for design improvements or discontinued without prior notice.