

General Description

This planar stripe MOSFET has better characteristics, such as fast switching time, low on resistance, low gate charge and excellent avalanche characteristics. It is mainly suitable for active power factor correction and switching mode power supplies.

FEATURES

- $V_{DSS}=600V$, $I_D=7.5A$
- Drain-Source ON Resistance :
 $R_{DS(ON)}=1.2 \Omega$ @ $V_{GS}=10V$
- $Qg(\text{typ.})= 32.5nC$

MAXIMUM RATING (Tc=25)

CHARACTERISTIC	SYMBOL	RATING		UNIT	
		KHB7D5N60P1	KHB7D5N60F1 KHB7D5N60F2		
Drain-Source Voltage	V_{DSS}	600		V	
Gate-Source Voltage	V_{GSS}	± 30		V	
Drain Current	@ $T_c=25^\circ C$	I_D	7.5	7.5*	A
	@ $T_c=100^\circ C$		4.6	4.6*	
	Pulsed (Note1)	I_{DP}	30	30*	
Single Pulsed Avalanche Energy (Note 2)	E_{AS}	230		mJ	
Repetitive Avalanche Energy (Note 1)	E_{AR}	14.7		mJ	
Peak Diode Recovery dv/dt (Note 3)	dv/dt	4.5		V/ns	
Drain Power Dissipation	$T_c=25^\circ C$	P_D	147	48	W
	Derate above $25^\circ C$		1.18	0.38	
Maximum Junction Temperature	T_j	150		$^\circ C$	
Storage Temperature Range	T_{stg}	-55 ~ 150		$^\circ C$	
Thermal Characteristics					
Thermal Resistance, Junction-to-Case	R_{thJC}	0.85	2.6	$^\circ C/W$	
Thermal Resistance, Case-to-Sink	R_{thCS}	0.5	-	$^\circ C/W$	
Thermal Resistance, Junction-to-Ambient	R_{thJA}	62.5	62.5	$^\circ C/W$	

* : Drain current limited by maximum junction temperature.

PIN CONNECTION

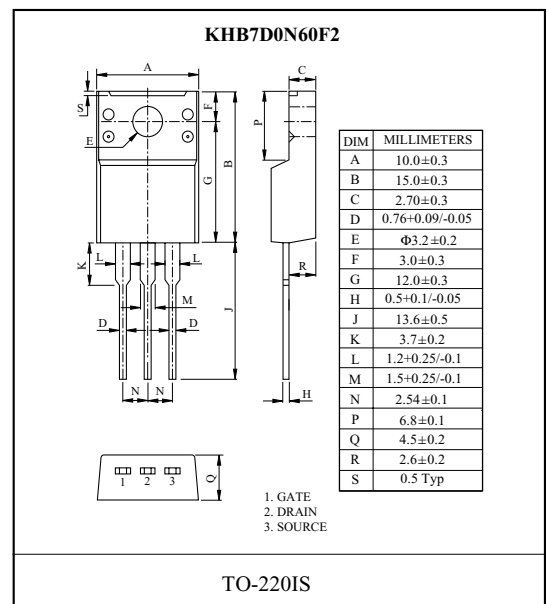
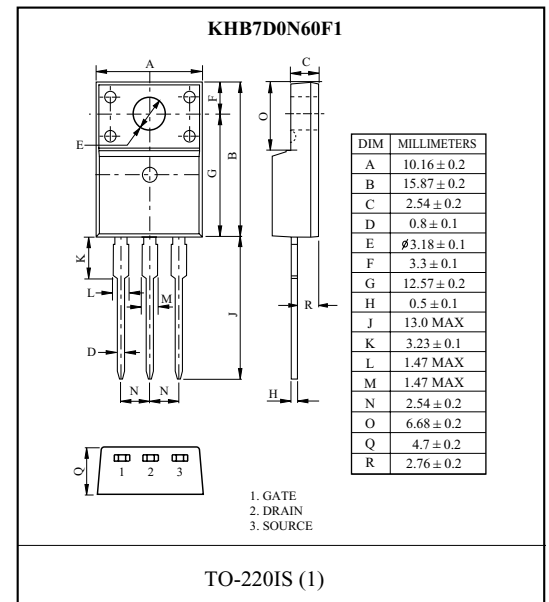
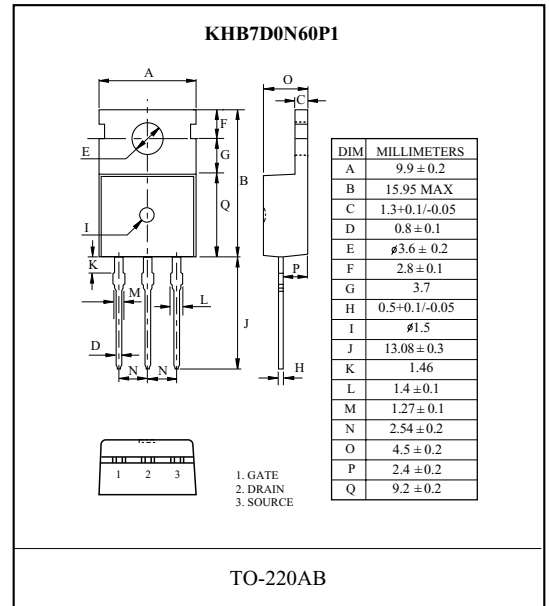
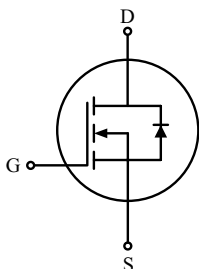

KHB7D5N60P1/F1/F2

ELECTRICAL CHARACTERISTICS (Tc=25 °C)

CHARACTERISTIC	SYMBOL	TEST CONDITION	MIN.	TYP.	MAX.	UNIT
Static						
Drain-Source Breakdown Voltage	BV_{DSS}	$I_D=250\mu A, V_{GS}=0V$	600	-	-	V
Breakdown Voltage Temperature Coefficient	$\Delta BV_{DSS}/\Delta T_j$	$I_D=250\mu A$, Referenced to 25 °C	-	0.7	-	V/°C
Drain Cut-off Current	I_{DSS}	$V_{DS}=600V, V_{GS}=0V$,	-	-	10	μA
Gate Threshold Voltage	V_{th}	$V_{DS}=V_{GS}, I_D=250\mu A$	2.0	-	4.0	V
Gate Leakage Current	I_{GSS}	$V_{GS}=\pm 30V, V_{DS}=0V$	-	-	± 100	nA
Drain-Source ON Resistance	$R_{DS(ON)}$	$V_{GS}=10V, I_D=3.75A$	-	1.0	1.2	Ω
Dynamic						
Total Gate Charge	Q_g	$V_{DS}=480V, I_D=7.5A$ $V_{GS}=10V$ (Note4,5)	-	32.5	43	nC
Gate-Source Charge	Q_{gs}		-	5.5	7.2	
Gate-Drain Charge	Q_{gd}		-	13.2	14.2	
Turn-on Delay time	$t_{d(on)}$	$V_{DD}=300V$ $R_L=40\Omega$ $R_G=25\Omega$ (Note4,5)	-	-	45	ns
Turn-on Rise time	t_r		-	-	130	
Turn-off Delay time	$t_{d(off)}$		-	-	220	
Turn-off Fall time	t_f		-	-	140	
Input Capacitance	C_{iss}	$V_{DS}=25V, V_{GS}=0V, f=1.0MHz$	-	1363	1550	pF
Output Capacitance	C_{oss}		-	121.8	140	
Reverse Transfer Capacitance	C_{rss}		-	17	21	
Source-Drain Diode Ratings						
Continuous Source Current	I_S	$V_{GS}<V_{th}$	-	-	7.5	A
Pulsed Source Current	I_{SP}		-	-	30	
Diode Forward Voltage	V_{SD}	$I_S=7.5A, V_{GS}=0V$	-	-	1.5	V
Reverse Recovery Time	t_{rr}	$I_S=7.5A, V_{GS}=0V$, $dI_S/dt=100A/\mu s$	-	359	-	ns
Reverse Recovery Charge	Q_{rr}		-	3.5	-	μC

Note 1) Repetivity rating : Pulse width limited by junction temperature.

Note 2) $L=7.3mH, I_S=7.5A, V_{DD}=50V, R_G=25\Omega$, Starting $T_j=25\text{ }^\circ\text{C}$.

Note 3) $I_S \leq 7.5A, dI/dt \leq 200A/\mu s, V_{DD} \leq BV_{DSS}$, Starting $T_j=25\text{ }^\circ\text{C}$.

Note 4) Pulse Test : Pulse width $\leq 300\mu s$, Duty Cycle $\leq 2\%$.

Note 5) Essentially independent of operating temperature.

KHB7D5N60P1/F1/F2

Fig1. $I_D - V_{DS}$

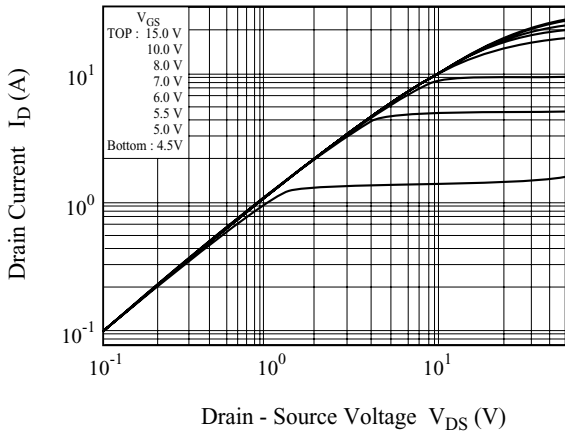

Fig2. $I_D - V_{GS}$

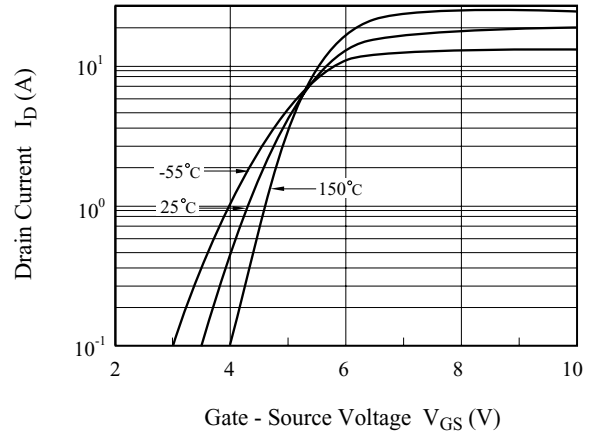

Fig3. $BV_{DSS} - T_j$

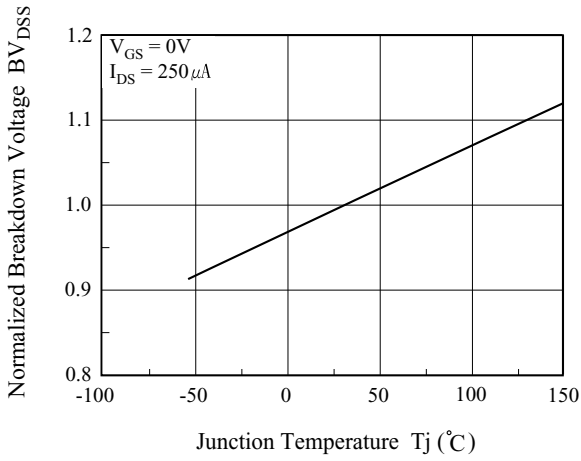

Fig4. $R_{DS(ON)} - I_D$

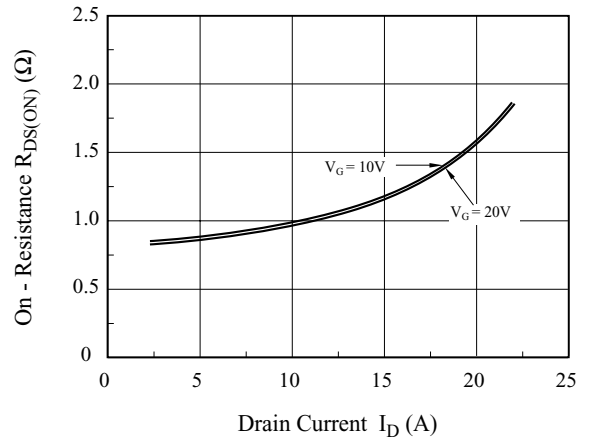

Fig5. $I_S - V_{SD}$

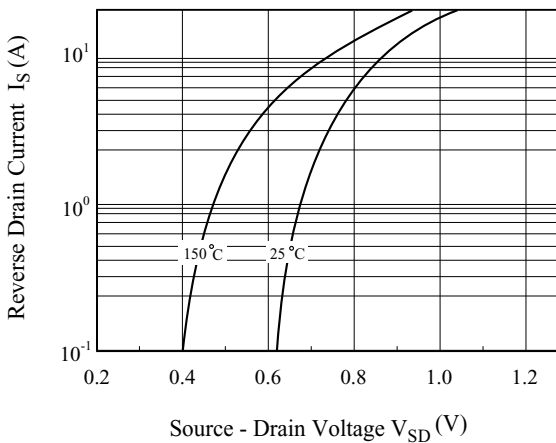
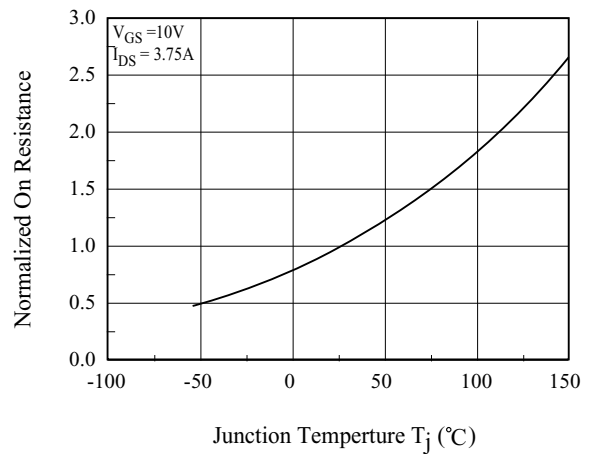

Fig6. $R_{DS(ON)} - T_j$



KHB7D5N60P1/F1/F2

Fig7. C - V_{DS}

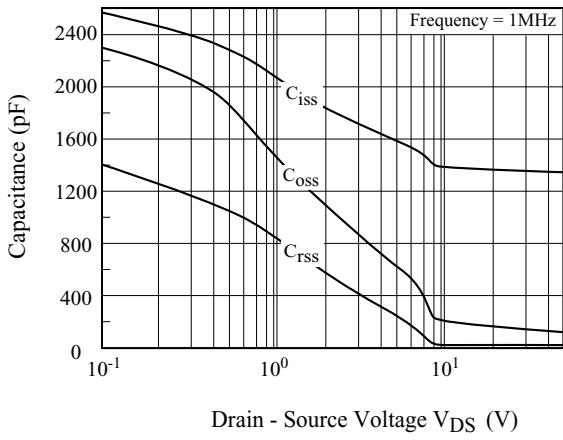

Fig8. Q_g- V_{GS}

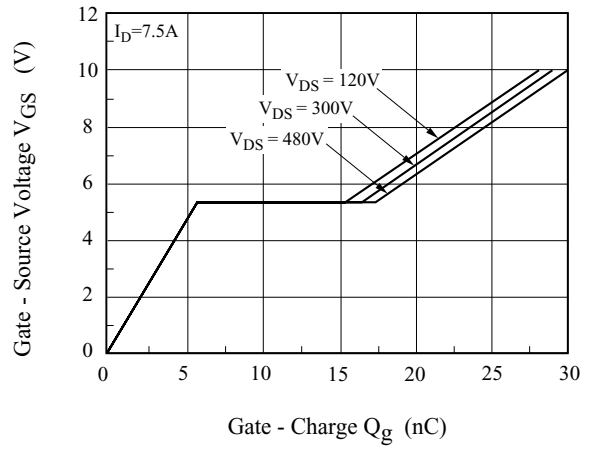

Fig9. Safe Operation Area

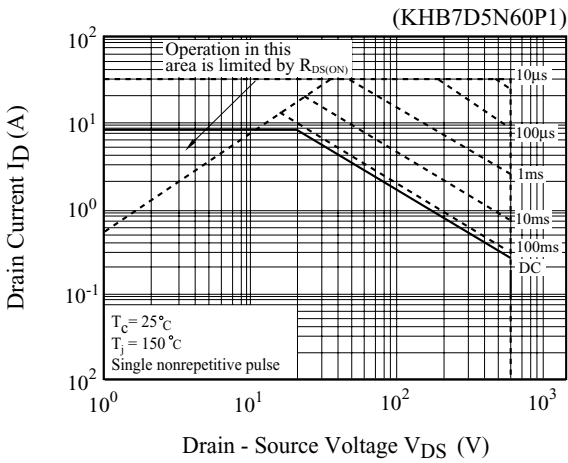

Fig10. Safe Operation Area

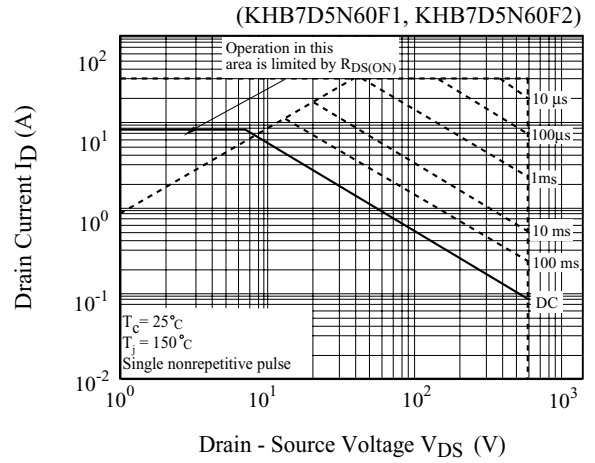
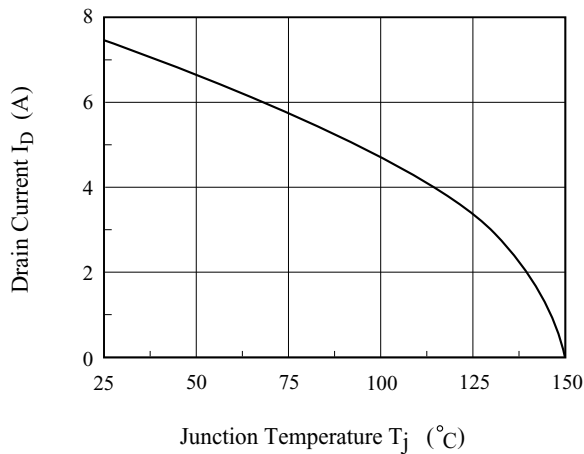

Fig11. I_D - T_j



KHB7D5N60P1/F1/F2

Fig12. Transient Thermal Response Curve

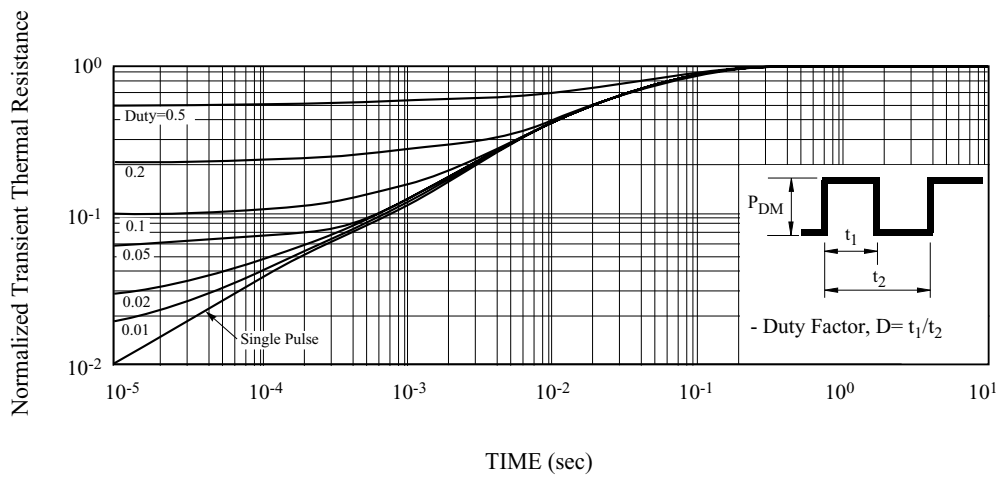

Fig13. Transient Thermal Response Curve

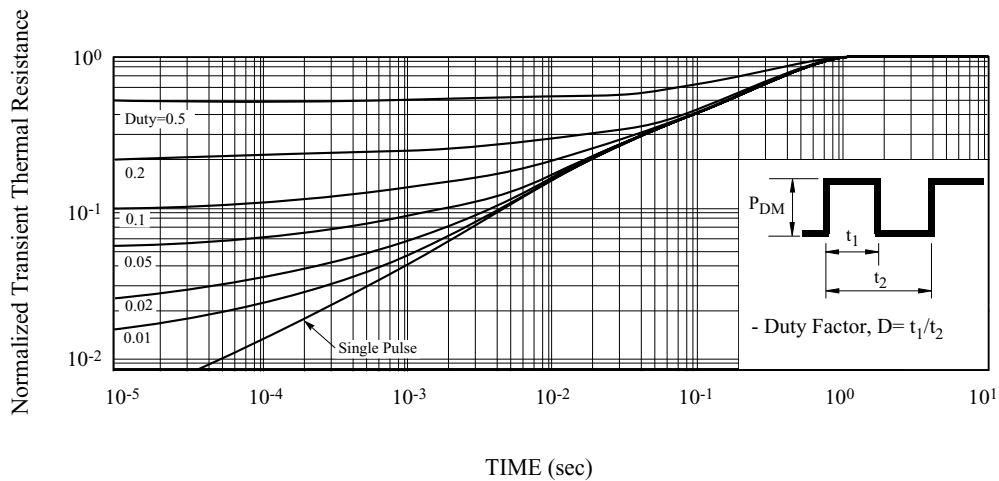

Fig14. Gate Charge

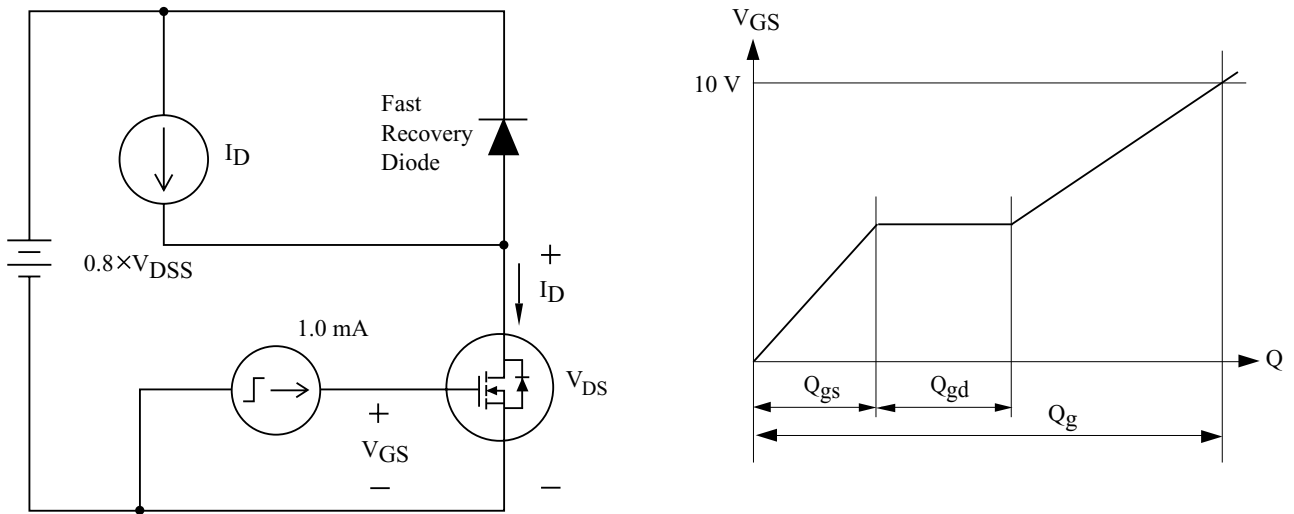

Fig15. Single Pulsed Avalanche Energy

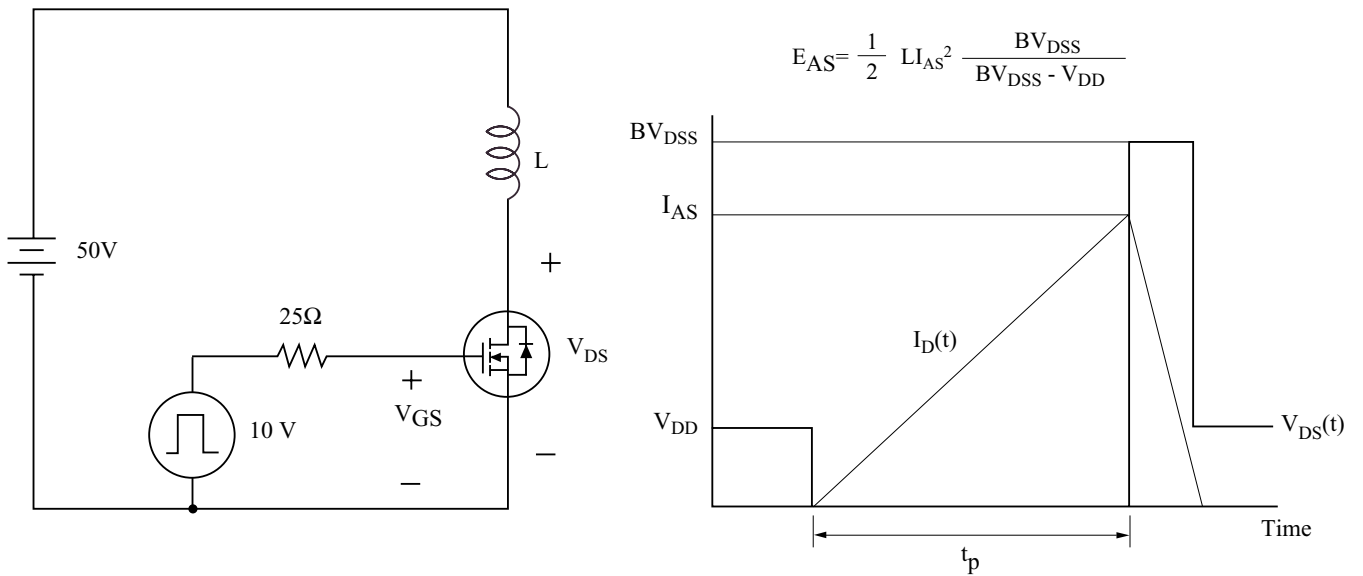

Fig16. Resistive Load Switching

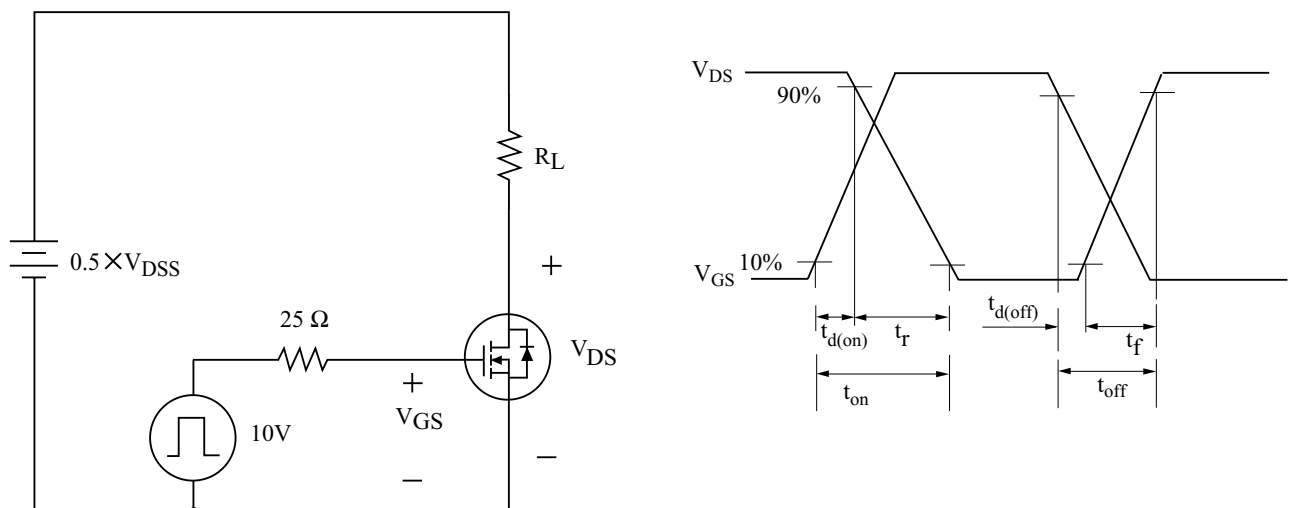

Fig17. Source - Drain Diode Reverse Recovery and dv/dt

