

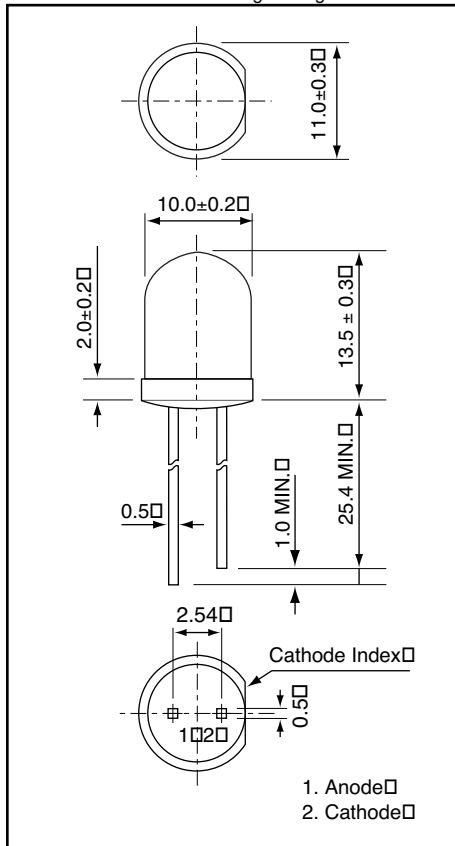

Weight: 1.0g Unit: mm



AND190HOP

InGaAlP High Brightness Orange Light Emission

T-3 Package (10 mm)

Features

- New emission material (InGaAlP) orange LED
- Peak wavelength ($\lambda_p = 620$ nm) high bright emission
- All plastic mold type, clear colorless lens
- Low drive current, (forward current = 1 to 20 mA)
- Excellent On-Off contrast ratio
- Fast response time, capable of pulse operation
- High power luminous intensity
- Suitable for Outdoor Message Signboards, Automotive use.
- **RoHS Compliant**

Maximum Ratings ($T_a = 25^\circ\text{C}$)

Characteristics	Symbol	Rating	Unit
Forward Current	I_F	50	mA
Reverse Voltage	V_R	5	V
Power Dissipation	P_D	125	mW
Operating Temperature Range	T_{Opr}	-40 to 85	$^\circ\text{C}$

Maximum Ratings ($T_a = 25^\circ\text{C}$)

Characteristics	Symbol	Rating	Unit
Storage Temperature Range	T_{Stg}	-40 to 100	$^\circ\text{C}$

Electro-Optical Characteristics ($T_a = 25^\circ\text{C}$)

Characteristics	Symbol	Test Condition	Minimum	Typical	Maximum	Unit
Forward Voltage	V_F	$I_F = 20$ mA	–	2.0	2.4	V
Reverse Current	I_R	$V_R = 5$ V	–	–	10	μA
Luminous Intensity	I_V	$I_F = 20$ mA	4,000	6,000	–	mcd
Peak Emission Wavelength	λ_p	$I_F = 20$ mA	–	620	–	nm
Spectral Line Half Width	$\Delta\lambda$	$I_F = 20$ mA	–	18	–	nm
Dominant Wavelength	λ_d	$I_F = 20$ mA	–	615	–	nm
Full Viewing Angle	θ	$I_V = 1/2$ Peak	–	6	–	degree

Precaution

Please be careful of the following:

1. Soldering temperature: 260 $^\circ\text{C}$ max

Soldering time: 5 sec. max

It is therefore advisable to contact Purdy Electronics before proceeding with the design of equipment incorporating this product.

Soldering portion of lead: up to 1.6 mm from the body of the device

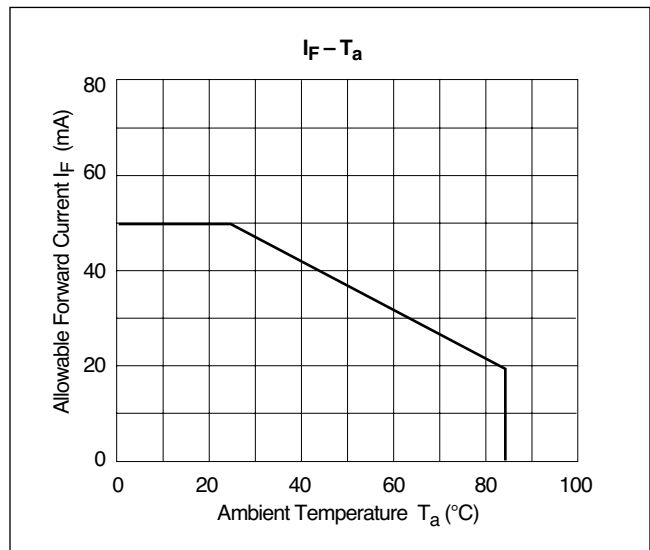
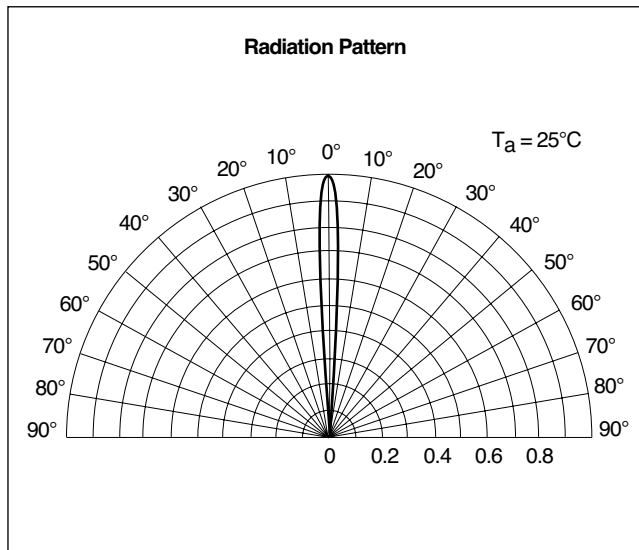
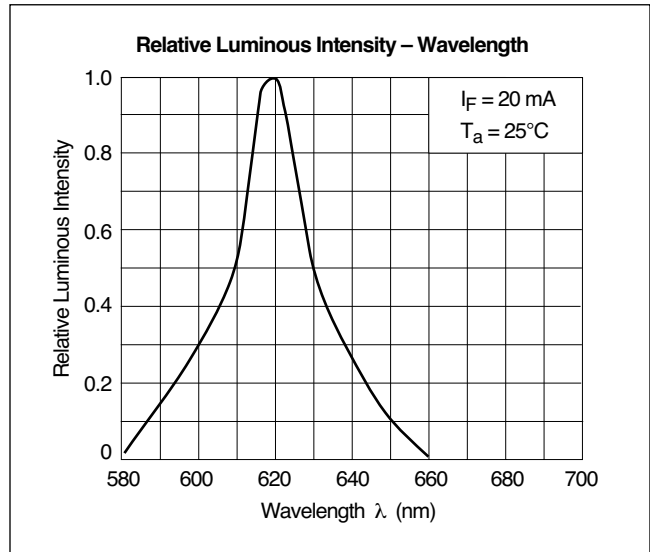
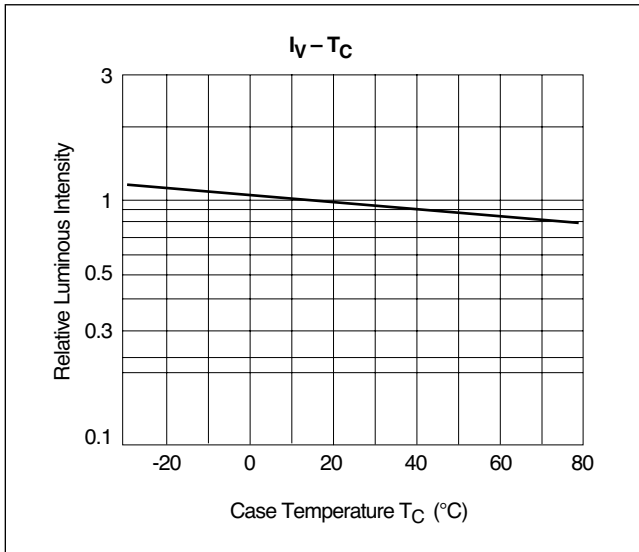
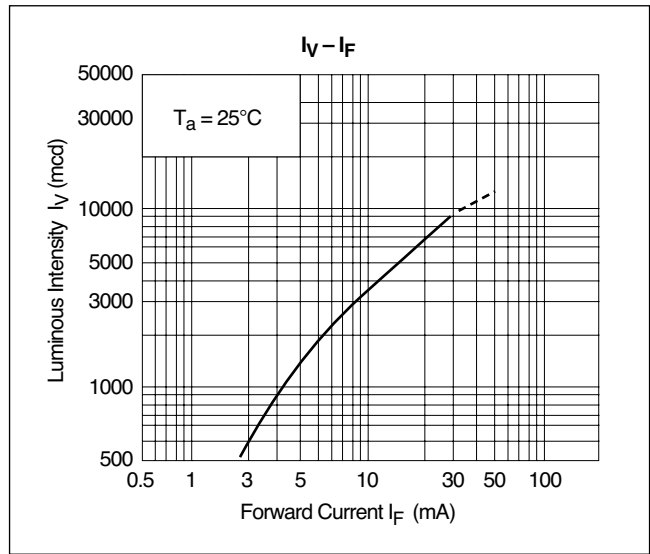
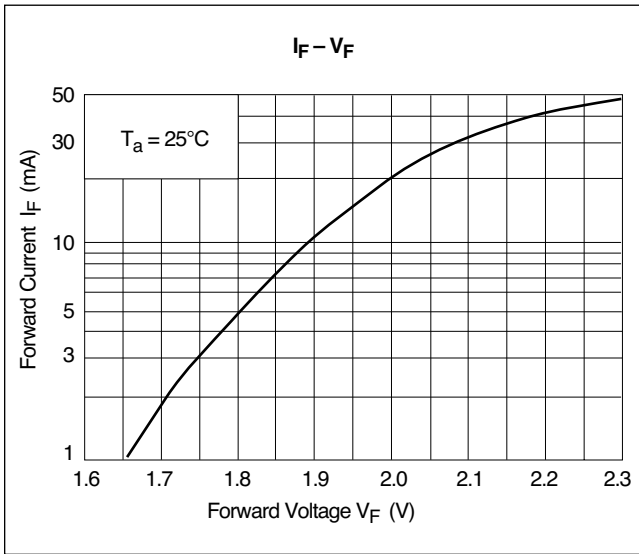

2. The lead can be formed up to 5 mm from the body of the device without forming stress.



InGaAlP High Brightness Orange Light Emission

AND190HOP
Ultra Bright LED Lamps: Type 3

Soldering should be performed after the lead forming.



InGaAlP High Brightness Orange Light Emission

AND190HOP
Ultra Bright LED Lamps: Type 3
