

1. PART NO. EXPRESSION :

C 2 - 1 N 0 S - 1 0
 (a) (b) (c) (d)

(a) Series code

(b) Inductance code : 1N0 = 1.0nH

(c) Tolerance code : S = $\pm 0.3nH$, J = $\pm 5\%$

(d) 10 : Lead Free

2. CONFIGURATION & DIMENSIONS :

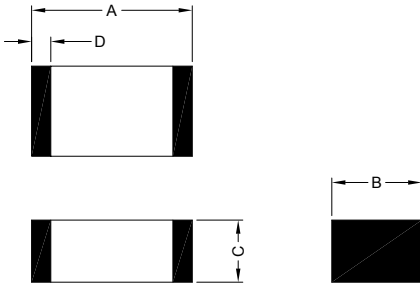

Unit:m/m

A	B	C	D
1.6 \pm 0.15	0.8 \pm 0.15	0.8 \pm 0.15	0.2 ~ 0.6

3. GENERAL SPECIFICATION :

- a) Operating temp. : -40°C to +85°C
- b) Storage temp. : -10°C to +40°C
- c) Humidity range : 70% RH Max.
- d) Resistance to solder heat : 265°C.6secs



RoHS Compliant

NOTE : Specifications subject to change without notice. Please check our website for latest information.

26.09.2008



SUPERWORLD ELECTRONICS (S) PTE LTD

6. ELECTRICAL CHARACTERISTICS :

Part Number	EIA Size	Inductance (nH)	Q Min.	Test Frequency (MHz)	SRF (GHz) Min.	DCR (Ω) Max.	Rated Current (mA) Max.
C2-1N0S-10	0603	1.0	8	100	10	0.05	300
C2-1N2S-10	0603	1.2	8	100	10	0.05	300
C2-1N5S-10	0603	1.5	8	100	6	0.10	300
C2-1N8S-10	0603	1.8	8	100	6	0.10	300
C2-2N2S-10	0603	2.2	8	100	6	0.10	300
C2-2N7S-10	0603	2.7	10	100	6	0.10	300
C2-3N3S-10	0603	3.3	10	100	6	0.12	300
C2-3N9S-10	0603	3.9	10	100	6	0.14	300
C2-4N7S-10	0603	4.7	10	100	4	0.16	300
C2-5N6S-10	0603	5.6	10	100	4	0.18	300
C2-6N8J-10	0603	6.8	10	100	4	0.22	300
C2-8N2J-10	0603	8.2	10	100	3.5	0.24	300
C2-10NJ-10	0603	10	12	100	3.4	0.26	300
C2-12NJ-10	0603	12	12	100	2.6	0.28	300
C2-15NJ-10	0603	15	12	100	2.3	0.32	300
C2-18NJ-10	0603	18	12	100	2.0	0.35	300
C2-22NJ-10	0603	22	12	100	1.6	0.40	300
C2-27NJ-10	0603	27	12	100	1.4	0.45	300
C2-33NJ-10	0603	33	12	100	1.2	0.55	300
C2-39NJ-10	0603	39	12	100	1.1	0.60	300
C2-47NJ-10	0603	47	12	100	0.9	0.70	300
C2-56NJ-10	0603	56	12	100	0.9	0.75	300
C2-68NJ-10	0603	68	12	100	0.7	0.85	300
C2-82NJ-10	0603	82	12	100	0.6	0.95	300
C2-R10J-10	0603	100	12	100	0.6	1.00	300
C2-R12J-10	0603	120	8	50	0.5	1.20	300
C2-R15J-10	0603	150	8	50	0.5	1.20	300
C2-R18J-10	0603	180	8	50	0.4	1.30	300
C2-R22J-10	0603	220	8	50	0.4	1.50	300

Tolerance code :

S : $\pm 0.3nH$

J : $\pm 5\%$



RoHS Compliant

NOTE : Specifications subject to change without notice. Please check our website for latest information.

26.09.2008



SUPERWORLD ELECTRONICS (S) PTE LTD

7. CHARACTERISTICS CURVES :

Inductance vs. Frequency

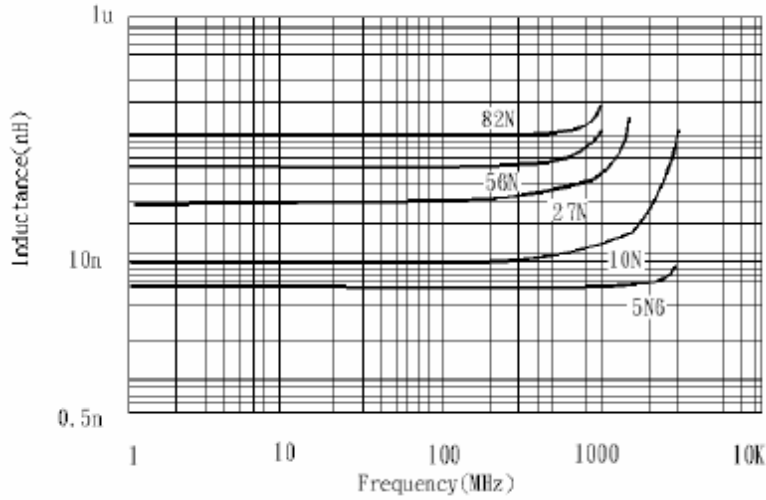

Q vs. Frequency

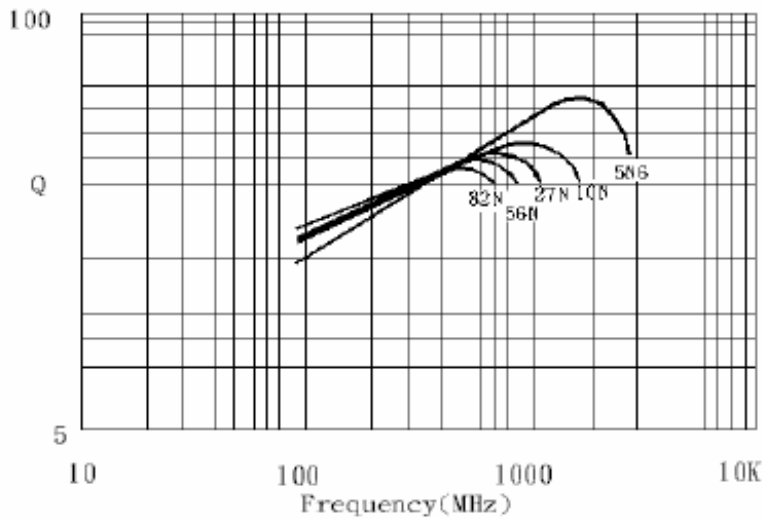

RoHS Compliant

NOTE : Specifications subject to change without notice. Please check our website for latest information.

26.09.2008



SUPERWORLD ELECTRONICS (S) PTE LTD

8. RELIABILITY & TEST CONDITION :

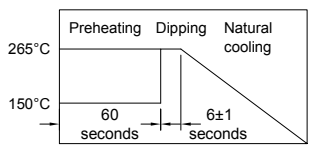
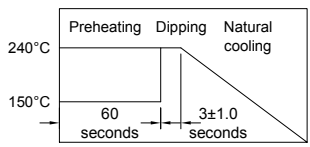
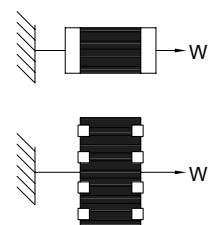
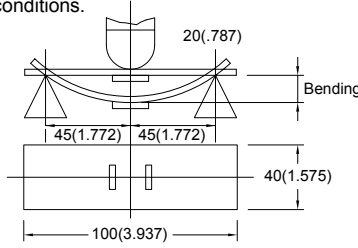
ITEM	PERFORMANCE	TEST CONDITION																											
Solder Heat Resistance	Appearance : Cracks should not be allowed. More than 75% of the terminal electrode should be covered with new solder.	Preheat : 100~150°C, 60sec. Solder : Sn-Ag3.0-Cu0.5 Solder Temperature : 265±3°C Flux : Rosin Dip Time : 6±1sec. 																											
Solderability	More than 90% of the terminal electrode should be covered with new solder.	Preheat : 150°C, 60sec. Solder : Sn-Ag3.0-Cu0.5 Solder Temperature : 240±5°C Flux : Rosin Dip Time : 3±1sec. 																											
Terminal Strength	The terminal electrode & the dielectric must not be damaged by the forces applied on the right conditions. 	For C Series : <table border="1" data-bbox="909 884 1252 1153"> <thead> <tr> <th>Size</th> <th>Force (Kfg)</th> <th>Time (sec)</th> </tr> </thead> <tbody> <tr> <td>1</td> <td>0.2</td> <td></td> </tr> <tr> <td>2</td> <td>0.5</td> <td></td> </tr> <tr> <td>3</td> <td>0.6</td> <td></td> </tr> <tr> <td>4</td> <td>1.0</td> <td>> 25</td> </tr> <tr> <td>5</td> <td>1.0</td> <td></td> </tr> <tr> <td>6</td> <td>1.0</td> <td></td> </tr> <tr> <td>7</td> <td>1.5</td> <td></td> </tr> <tr> <td>8</td> <td>2.0</td> <td></td> </tr> </tbody> </table>	Size	Force (Kfg)	Time (sec)	1	0.2		2	0.5		3	0.6		4	1.0	> 25	5	1.0		6	1.0		7	1.5		8	2.0	
Size	Force (Kfg)	Time (sec)																											
1	0.2																												
2	0.5																												
3	0.6																												
4	1.0	> 25																											
5	1.0																												
6	1.0																												
7	1.5																												
8	2.0																												
Flexture Strength	The terminal electrode & the dielectric must not be damaged by the forces applied on the right conditions. 	Solder a chip on a test substrate, bend the substrate by 3mm (0.118in) for 10secs and return.																											



RoHS Compliant

NOTE : Specifications subject to change without notice. Please check our website for latest information.

26.09.2008



SUPERWORLD ELECTRONICS (S) PTE LTD

PG. 4

8. RELIABILITY & TEST CONDITION :

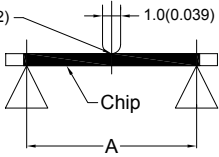
ITEM	PERFORMANCE	TEST CONDITION									
Bending Strength	<p>The ferrite should not be damaged by forces applied on the right condition.</p> 										
High Temperature Resistance	<p>Appearance : No damage. Inductance : Within $\pm 20\%$ of initial value.</p>	<p>Temperature : $85 \pm 5^\circ\text{C}$ Applied Current : rated current Duration : 1008 ± 12hrs Measurement : After placing for at least 24hrs.</p>									
Humidity Resistance		<p>Humidity : 90~95% RH. Temperature : $60 \pm 2^\circ\text{C}$ Applied Current : rated current (max.) Duration : 1008 ± 12hrs Measurement : After placing for at least 24hrs.</p>									
Thermal Shock	<p>Appearance : Cracking, chipping or any other defects that are harmful to the characteristics shall not be allowed. Inductance : Within $\pm 20\%$ of initial value.</p> <table border="1" data-bbox="469 1070 874 1160"> <thead> <tr> <th>Phase</th> <th>Temperature ($^\circ\text{C}$)</th> <th>Times (min.)</th> </tr> </thead> <tbody> <tr> <td>1</td> <td>$-40 \pm 2^\circ\text{C}$</td> <td>30</td> </tr> <tr> <td>2</td> <td>$+85 \pm 5^\circ\text{C}$</td> <td>30</td> </tr> </tbody> </table>	Phase	Temperature ($^\circ\text{C}$)	Times (min.)	1	$-40 \pm 2^\circ\text{C}$	30	2	$+85 \pm 5^\circ\text{C}$	30	<p>For C Series : Condition for 1 cycle Step1 : $-40 \pm 2^\circ\text{C}$ 30 min. Step2 : $+85 \pm 5^\circ\text{C}$ 30 min. Number of cycles : 100 Measurement : After placing for at least 24hrs.</p>
Phase	Temperature ($^\circ\text{C}$)	Times (min.)									
1	$-40 \pm 2^\circ\text{C}$	30									
2	$+85 \pm 5^\circ\text{C}$	30									
Low temperature storage test	<p>Measured : 100 times</p>	<p>Temperature : $-40 \pm 2^\circ\text{C}$ Duration : 1008 ± 12hrs Measurement : After placing for at least 24hrs.</p>									



RoHS Compliant

NOTE : Specifications subject to change without notice. Please check our website for latest information.

26.09.2008



SUPERWORLD ELECTRONICS (S) PTE LTD

9. SOLDERING :

9-1. Reflow soldering conditions

Pre-heating should be in such a way that the temperature difference between solder and ferrite surface is limited to 150°C max. Also cooling into the solvent after soldering should be in such a way that the temperature difference is limited to 100°C max. Insufficient pre-heating may cause cracks on the ferrite, resulting in the deterioration of product quality.

Products should be soldered within the following allowable range indicated by the slanted line. The excessive soldering conditions may cause the corrosion of the electrode. When soldering is repeated, allowable time is the accumulated time.

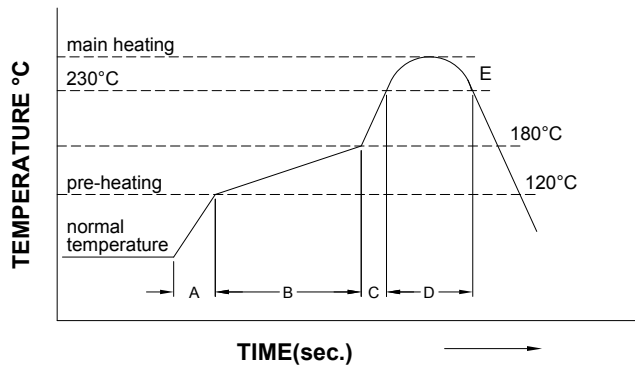
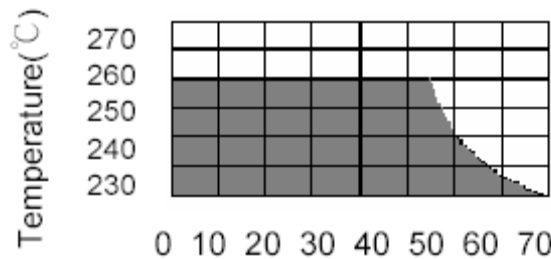

A	Slope of temp. rise	1 to 5	°C/sec
B	Heat time	50 to 150	sec
	Heat temperature	120 to 180	°C
C	Slope of temp. rise	1 to 5	°C/sec
D	Time over 230°C	90 ~ 120	sec
E	Peak temperature	255 ~ 260	°C
	Peak hold time	10 max.	sec
No. of mounting		3	times

(Melting area of solder)

9-2. Soldering Iron

Products attachment with soldering iron is discouraged due to the inherent process control limitations. In the event that a soldering iron must be employed the following precautions are recommended.

Note :

- a) Preheat circuit and products to 150°C.
- b) 280°C tip temperature (max)
- c) Never contact the ceramic with the iron tip
- d) 3.0mm tip diameter (max)
- e) Use a 30 watt max. soldering iron with tip diameter of 3.0mm
- f) Limit soldering time to 3 secs.

9-3. Solder Volume :

Accordingly increasing the solder volume, the mechanical stress to product is also increased. Exceeding solder volume may cause the failure of mechanical or electrical performance. Solder shall be used not to be exceed as shown in right side.

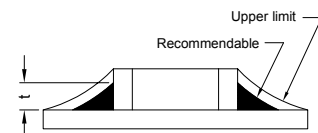

RoHS Compliant

NOTE : Specifications subject to change without notice. Please check our website for latest information.

26.09.2008



SUPERWORLD ELECTRONICS (S) PTE LTD

10. PACKAGING INFORMATION :

10-1. Carrier Tape Packaging

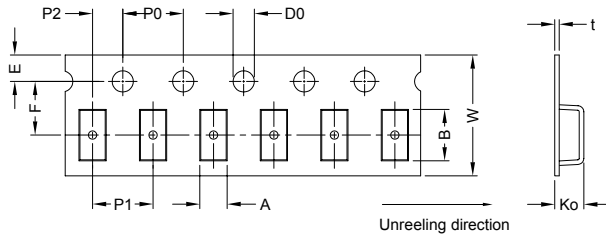

A(mm)	B(mm)	W(mm)	F(mm)	E(mm)	P1(mm)	P2(mm)	P0(mm)	D0(mm)	Ko(mm)	t(mm)
1.1±0.1	1.9±0.1	8±0.2	3.5±0.05	1.75±0.1	4±0.1	2±0.05	4±0.1	1.5 ^{+0.1} ₋₀	1.1±0.05	0.2±0.05

10-2. Leader And Trailer Tape

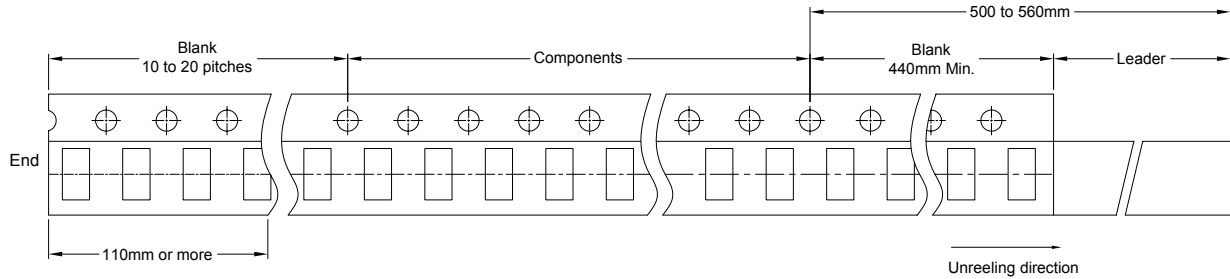

10-3. Configuration

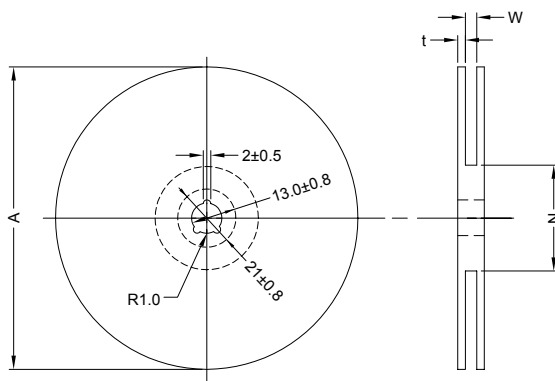

A(mm)	N(mm)	W(mm)	t(mm)	Qty (pcs)
178±2.0	Ø60±2	10±1.5	2±0.5	4000/Reel



RoHS Compliant

NOTE : Specifications subject to change without notice. Please check our website for latest information.

26.09.2008



SUPERWORLD ELECTRONICS (S) PTE LTD