

24 MHz, 2.5 mA Op Amps

Features

- Gain Bandwidth Product: 24 MHz (typical)
- Short Circuit Current: 70 mA (typical)
- Noise: 10 nV/ $\sqrt{\text{Hz}}$ (typical, at 1 MHz)
- Rail-to-Rail Output
- Slew Rate: 10 V/ μs (typical)
- Supply Current: 2.5 mA (typical)
- Power Supply: 2.5V to 5.5V
- Extended Temperature Range: -40°C to +125°C

Typical Applications

- Driving A/D Converters
- Power Amplifier Control Loops
- Barcode Scanners
- Optical Detector Amplifier

Design Aids

- SPICE Macro Models
- FilterLab[®] Software
- Mindi[™] Circuit Designer & Simulator
- Microchip Advanced Part Selector (MAPS)
- Analog Demonstration and Evaluation Boards
- Application Notes

Description

The Microchip Technology, Inc. MCP631/2/3/5 family of operational amplifiers features high gain bandwidth product (24 MHz, typical) and high output short circuit current (70 mA, typical). Some also provide a Chip Select pin (CS) that supports a low power mode of operation. These amplifiers are optimized for high speed, low noise and distortion, single-supply operation with rail-to-rail output and an input that includes the negative rail.

This family is offered in single (MCP631), single with CS pin (MCP633), dual (MCP632) and dual with two CS pins (MCP635). All devices are fully specified from -40°C to +125°C.

Typical Application Circuit

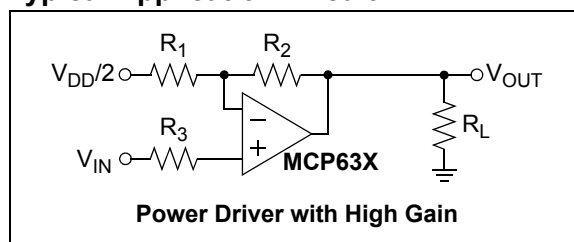

Package Types

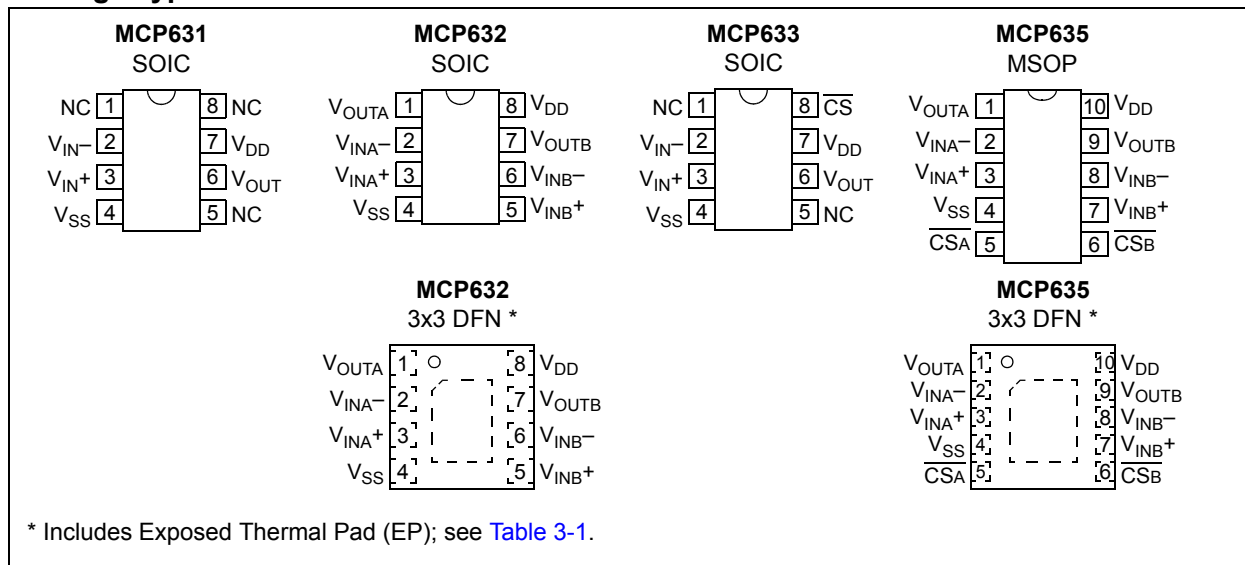

MCP631/2/3/5

NOTES:

1.0 ELECTRICAL CHARACTERISTICS

1.1 Absolute Maximum Ratings †

| | |
|---|------------------------------------|
| $V_{DD} - V_{SS}$ | 6.5V |
| Current at Input Pins | ±2 mA |
| Analog Inputs (V_{IN+} and V_{IN-}) †† . $V_{SS} - 1.0V$ to $V_{DD} + 1.0V$ | |
| All other Inputs and Outputs | $V_{SS} - 0.3V$ to $V_{DD} + 0.3V$ |
| Output Short Circuit Current | Continuous |
| Current at Output and Supply Pins | ±150 mA |
| Storage Temperature | -65°C to +150°C |
| Max. Junction Temperature | +150°C |
| ESD protection on all pins (HBM, MM) | ≥ 1 kV, 200V |

† **Notice:** Stresses above those listed under “Absolute Maximum Ratings” may cause permanent damage to the device. This is a stress rating only and functional operation of the device at those or any other conditions above those indicated in the operational listings of this specification is not implied. Exposure to maximum rating conditions for extended periods may affect device reliability.

†† See Section 4.1.2 “Input Voltage and Current Limits”.

1.2 Specifications

TABLE 1-1: DC ELECTRICAL SPECIFICATIONS

| Electrical Characteristics: Unless otherwise indicated, $T_A = +25^\circ\text{C}$, $V_{DD} = +2.5V$ to $+5.5V$, $V_{SS} = \text{GND}$, $V_{CM} = V_{DD}/3$, $V_{OUT} \approx V_{DD}/2$, $V_L = V_{DD}/2$, $R_L = 2\text{ k}\Omega$ to V_L and $\text{CS} = V_{SS}$ (refer to Figure 1-2). | | | | | | |
|---|----------------------------|----------------|--------------|----------------|------------------------------|---|
| Parameters | Sym | Min | Typ | Max | Units | Conditions |
| Input Offset | | | | | | |
| Input Offset Voltage | V_{OS} | -8 | ±1.8 | +8 | mV | |
| Input Offset Voltage Drift | $\Delta V_{OS}/\Delta T_A$ | — | ±2.0 | — | $\mu\text{V}/^\circ\text{C}$ | $T_A = -40^\circ\text{C}$ to $+125^\circ\text{C}$ |
| Power Supply Rejection Ratio | PSRR | 61 | 76 | — | dB | |
| Input Current and Impedance | | | | | | |
| Input Bias Current | I_B | — | 4 | — | pA | |
| Across Temperature | I_B | — | 100 | — | pA | $T_A = +85^\circ\text{C}$ |
| Across Temperature | I_B | — | 1500 | 5,000 | pA | $T_A = +125^\circ\text{C}$ |
| Input Offset Current | I_{OS} | — | ±2 | — | pA | |
| Common Mode Input Impedance | Z_{CM} | — | $10^{13} 9$ | — | ΩpF | |
| Differential Input Impedance | Z_{DIFF} | — | $10^{13} 2$ | — | ΩpF | |
| Common Mode | | | | | | |
| Common-Mode Input Voltage Range | V_{CMR} | $V_{SS} - 0.3$ | — | $V_{DD} - 1.3$ | V | (Note 1) |
| Common-Mode Rejection Ratio | CMRR | 63 | 78 | — | dB | $V_{DD} = 2.5V$, $V_{CM} = -0.3$ to $1.2V$ |
| | CMRR | 66 | 81 | — | dB | $V_{DD} = 5.5V$, $V_{CM} = -0.3$ to $4.2V$ |
| Open Loop Gain | | | | | | |
| DC Open Loop Gain (large signal) | A_{OL} | 88 | 115 | — | dB | $V_{DD} = 2.5V$, $V_{OUT} = 0.3V$ to $2.2V$ |
| | A_{OL} | 94 | 124 | — | dB | $V_{DD} = 5.5V$, $V_{OUT} = 0.3V$ to $5.2V$ |
| Output | | | | | | |
| Maximum Output Voltage Swing | V_{OL}, V_{OH} | $V_{SS} + 20$ | — | $V_{DD} - 20$ | mV | $V_{DD} = 2.5V$, $G = +2$, $0.5V$ Input Overdrive |
| | V_{OL}, V_{OH} | $V_{SS} + 40$ | — | $V_{DD} - 40$ | mV | $V_{DD} = 5.5V$, $G = +2$, $0.5V$ Input Overdrive |
| Output Short Circuit Current | I_{SC} | ±40 | ±85 | ±130 | mA | $V_{DD} = 2.5V$ (Note 2) |
| | I_{SC} | ±35 | ±70 | ±110 | mA | $V_{DD} = 5.5V$ (Note 2) |
| Power Supply | | | | | | |
| Supply Voltage | V_{DD} | 2.5 | — | 5.5 | V | |
| Quiescent Current per Amplifier | I_Q | 1.2 | 2.5 | 3.6 | mA | No Load Current |

Note 1: See Figure 2-5 for temperature effects.

2: The I_{SC} specifications are for design guidance only; they are not tested.

MCP631/2/3/5

TABLE 1-2: AC ELECTRICAL SPECIFICATIONS

Electrical Characteristics: Unless otherwise indicated, $T_A = +25^\circ\text{C}$, $V_{DD} = +2.5\text{V}$ to $+5.5\text{V}$, $V_{SS} = \text{GND}$, $V_{CM} = V_{DD}/2$, $V_{OUT} \approx V_{DD}/2$, $V_L = V_{DD}/2$, $R_L = 2\text{ k}\Omega$ to V_L , $C_L = 50\text{ pF}$ and $\overline{\text{CS}} = V_{SS}$ (refer to [Figure 1-2](#)).

| Parameters | Sym | Min | Typ | Max | Units | Conditions |
|--------------------------------------|-----------|-----|--------|-----|------------------------|--|
| AC Response | | | | | | |
| Gain Bandwidth Product | GBWP | — | 24 | — | MHz | |
| Phase Margin | PM | — | 65 | — | ° | $G = +1$ |
| Open Loop Output Impedance | R_{OUT} | — | 20 | — | Ω | |
| AC Distortion | | | | | | |
| Total Harmonic Distortion plus Noise | THD+N | — | 0.0015 | — | % | $G = +1$, $V_{OUT} = 2V_{P-P}$, $f = 1\text{ kHz}$, $V_{DD} = 5.5\text{V}$, $BW = 80\text{ kHz}$ |
| Step Response | | | | | | |
| Rise Time, 10% to 90% | t_r | — | 20 | — | ns | $G = +1$, $V_{OUT} = 100\text{ mV}_{P-P}$ |
| Slew Rate | SR | — | 10 | — | V/ μs | $G = +1$ |
| Noise | | | | | | |
| Input Noise Voltage | E_{ni} | — | 16 | — | μV_{P-P} | $f = 0.1\text{ Hz}$ to 10 Hz |
| Input Noise Voltage Density | e_{ni} | — | 10 | — | nV/ $\sqrt{\text{Hz}}$ | $f = 1\text{ MHz}$ |
| Input Noise Current Density | i_{ni} | — | 4 | — | fA/ $\sqrt{\text{Hz}}$ | $f = 1\text{ kHz}$ |

TABLE 1-3: DIGITAL ELECTRICAL SPECIFICATIONS

Electrical Characteristics: Unless otherwise indicated, $T_A = +25^\circ\text{C}$, $V_{DD} = +2.5\text{V}$ to $+5.5\text{V}$, $V_{SS} = \text{GND}$, $V_{CM} = V_{DD}/2$, $V_{OUT} \approx V_{DD}/2$, $V_L = V_{DD}/2$, $R_L = 2\text{ k}\Omega$ to V_L , $C_L = 50\text{ pF}$ and $\overline{\text{CS}} = V_{SS}$ (refer to [Figure 1-1](#) and [Figure 1-2](#)).

| Parameters | Sym | Min | Typ | Max | Units | Conditions |
|--|---------------|-------------|------|-------------|---------------|---|
| $\overline{\text{CS}}$ Low Specifications | | | | | | |
| $\overline{\text{CS}}$ Logic Threshold, Low | V_{IL} | V_{SS} | — | $0.2V_{DD}$ | V | |
| $\overline{\text{CS}}$ Input Current, Low | I_{CSL} | — | 0.1 | — | nA | $\overline{\text{CS}} = 0\text{V}$ |
| $\overline{\text{CS}}$ High Specifications | | | | | | |
| $\overline{\text{CS}}$ Logic Threshold, High | V_{IH} | $0.8V_{DD}$ | — | V_{DD} | V | |
| $\overline{\text{CS}}$ Input Current, High | I_{CSH} | — | 0.7 | — | μA | $\overline{\text{CS}} = V_{DD}$ |
| GND Current | I_{SS} | -2 | -1 | — | μA | |
| $\overline{\text{CS}}$ Internal Pull Down Resistor | R_{PD} | — | 5 | — | M Ω | |
| Amplifier Output Leakage | $I_{O(LEAK)}$ | — | 50 | — | nA | $\overline{\text{CS}} = V_{DD}$, $T_A = +125^\circ\text{C}$ |
| $\overline{\text{CS}}$ Dynamic Specifications | | | | | | |
| $\overline{\text{CS}}$ Input Hysteresis | V_{HYST} | — | 0.25 | — | V | |
| $\overline{\text{CS}}$ High to Amplifier Off Time (output goes High-Z) | t_{OFF} | — | 200 | — | ns | $G = +1\text{ V/V}$, $V_L = V_{SS}$ $\overline{\text{CS}} = 0.8V_{DD}$ to $V_{OUT} = 0.1(V_{DD}/2)$ |
| $\overline{\text{CS}}$ Low to Amplifier On Time | t_{ON} | — | 2 | 10 | μs | $G = +1\text{ V/V}$, $V_L = V_{SS}$, $\overline{\text{CS}} = 0.2V_{DD}$ to $V_{OUT} = 0.9(V_{DD}/2)$ |

TABLE 1-4: TEMPERATURE SPECIFICATIONS

| Electrical Characteristics: Unless otherwise indicated, all limits are specified for: $V_{DD} = +2.5V$ to $+5.5V$, $V_{SS} = GND$. | | | | | | |
|--|---------------|-----|-------|------|---------------|------------|
| Parameters | Sym | Min | Typ | Max | Units | Conditions |
| Temperature Ranges | | | | | | |
| Specified Temperature Range | T_A | -40 | — | +125 | $^{\circ}C$ | |
| Operating Temperature Range | T_A | -40 | — | +125 | $^{\circ}C$ | (Note 1) |
| Storage Temperature Range | T_A | -65 | — | +150 | $^{\circ}C$ | |
| Thermal Package Resistances | | | | | | |
| Thermal Resistance, 8L-3x3 DFN | θ_{JA} | — | 60 | — | $^{\circ}C/W$ | (Note 2) |
| Thermal Resistance, 8L-SOIC | θ_{JA} | — | 149.5 | — | $^{\circ}C/W$ | |
| Thermal Resistance, 10L-3x3 DFN | θ_{JA} | — | 57 | — | $^{\circ}C/W$ | (Note 2) |
| Thermal Resistance, 10L-MSOP | θ_{JA} | — | 202 | — | $^{\circ}C/W$ | |

- Note 1:** Operation must not cause T_J to exceed Maximum Junction Temperature specification ($+150^{\circ}C$).
Note 2: Measured on a standard JC51-7, four layer printed circuit board with ground plane and vias.

1.3 Timing Diagram

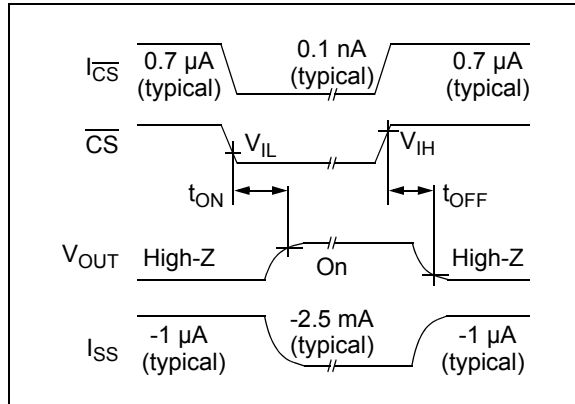

FIGURE 1-1: Timing Diagram.

EQUATION 1-1:

$$G_{DM} = R_F/R_G$$

$$G_N = 1 + G_{DM}$$

$$V_{CM} = V_P(1 - 1/G_N) + V_{REF}(1/G_N)$$

$$V_{OST} = V_{IN-} - V_{IN+}$$

$$V_{OUT} = V_{REF} + (V_P - V_M)G_{DM} + V_{OST}G_N$$

Where:

- G_{DM} = Differential Mode Gain (V/V)
- G_N = Noise Gain (V/V)
- V_{CM} = Op Amp's Common Mode Input Voltage (V)
- V_{OST} = Op Amp's Total Input Offset Voltage (mV)

1.4 Test Circuits

The circuit used for most DC and AC tests is shown in Figure 1-2. It independently sets V_{CM} and V_{OUT} ; see Equation 1-1. The circuit's common mode voltage is $(V_P + V_M)/2$, not V_{CM} . V_{OST} includes V_{OS} plus the effects of temperature, CMRR, PSRR and A_{OL} .

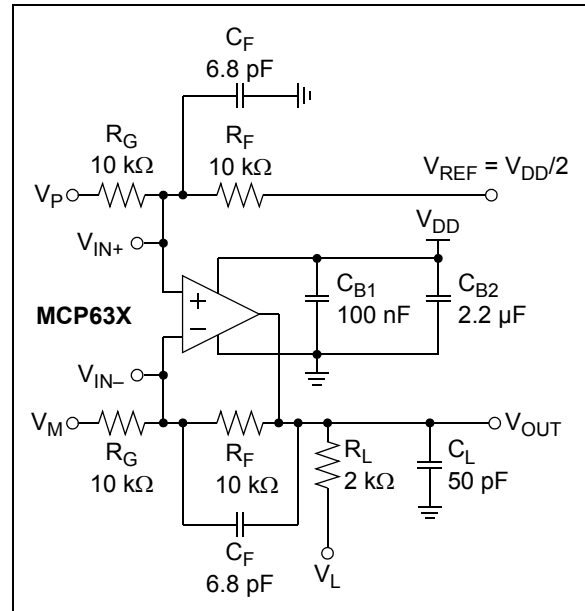

FIGURE 1-2: AC and DC Test Circuit for Most Specifications.

MCP631/2/3/5

NOTES:

2.0 TYPICAL PERFORMANCE CURVES

Note: The graphs and tables provided following this note are a statistical summary based on a limited number of samples and are provided for informational purposes only. The performance characteristics listed herein are not tested or guaranteed. In some graphs or tables, the data presented may be outside the specified operating range (e.g., outside specified power supply range) and therefore outside the warranted range.

Note: Unless otherwise indicated, $T_A = +25^\circ\text{C}$, $V_{DD} = +2.5\text{V}$ to 5.5V , $V_{SS} = \text{GND}$, $V_{CM} = V_{DD}/3$, $V_{OUT} = V_{DD}/2$, $V_L = V_{DD}/2$, $R_L = 2\text{ k}\Omega$ to V_L , $C_L = 50\text{ pF}$ and $\overline{CS} = V_{SS}$.

2.1 DC Signal Inputs

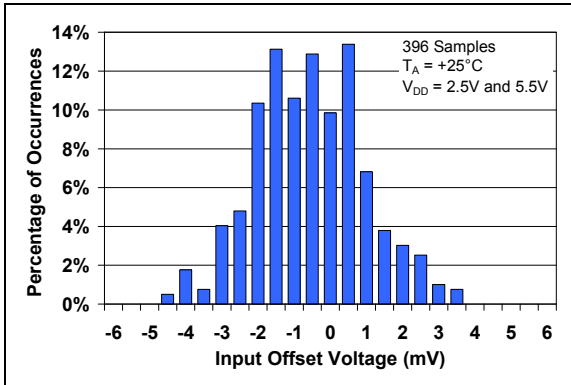

FIGURE 2-1: Input Offset Voltage.

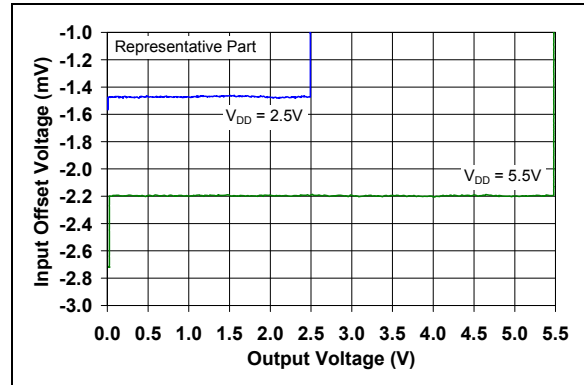

FIGURE 2-4: Input Offset Voltage vs. Output Voltage.

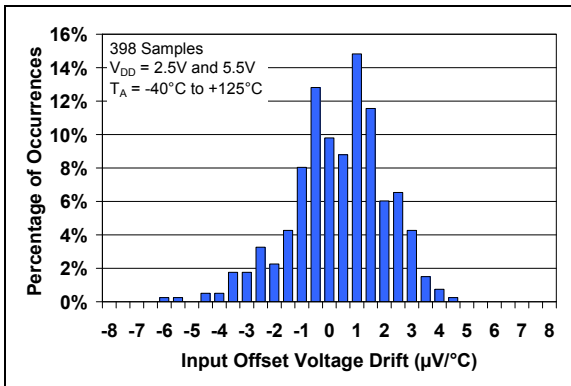

FIGURE 2-2: Input Offset Voltage Drift.

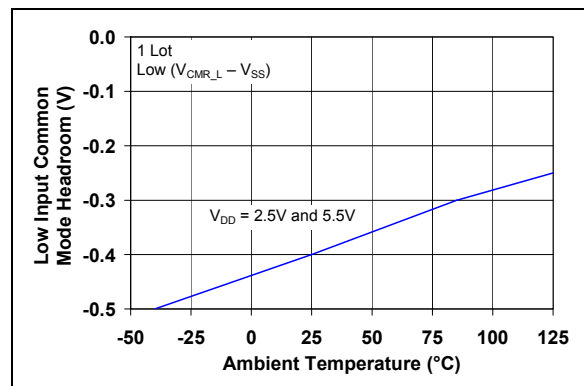

FIGURE 2-5: Low Input Common Mode Voltage Headroom vs. Ambient Temperature.

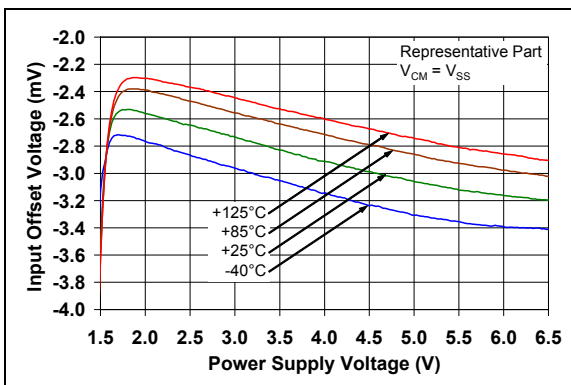

FIGURE 2-3: Input Offset Voltage vs. Power Supply Voltage with $V_{CM} = 0\text{V}$.

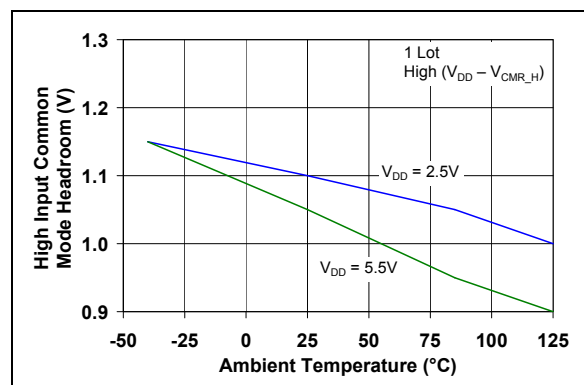

FIGURE 2-6: High Input Common Mode Voltage Headroom vs. Ambient Temperature.

MCP631/2/3/5

Note: Unless otherwise indicated, $T_A = +25^\circ\text{C}$, $V_{DD} = +2.5\text{V}$ to 5.5V , $V_{SS} = \text{GND}$, $V_{CM} = V_{DD}/3$, $V_{OUT} = V_{DD}/2$, $V_L = V_{DD}/2$, $R_L = 2\text{ k}\Omega$ to V_L , $C_L = 50\text{ pF}$ and $\overline{\text{CS}} = V_{SS}$.

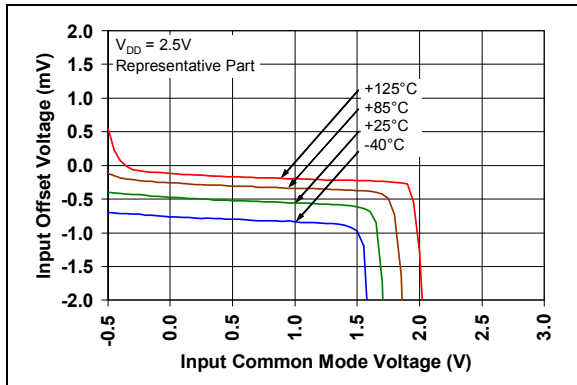

FIGURE 2-7: Input Offset Voltage vs. Common Mode Voltage with $V_{DD} = 2.5\text{V}$.

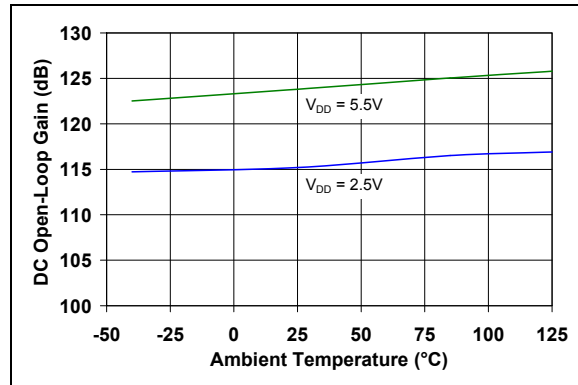

FIGURE 2-10: DC Open-Loop Gain vs. Ambient Temperature.

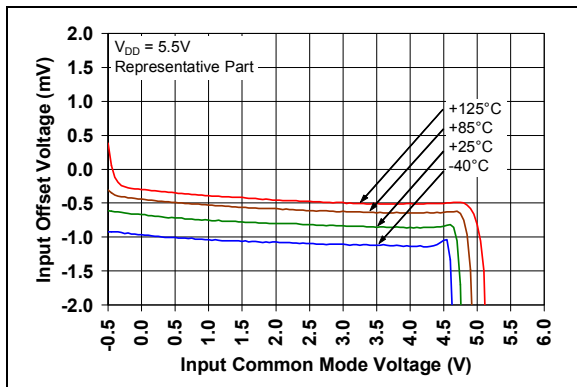

FIGURE 2-8: Input Offset Voltage vs. Common Mode Voltage with $V_{DD} = 5.5\text{V}$.

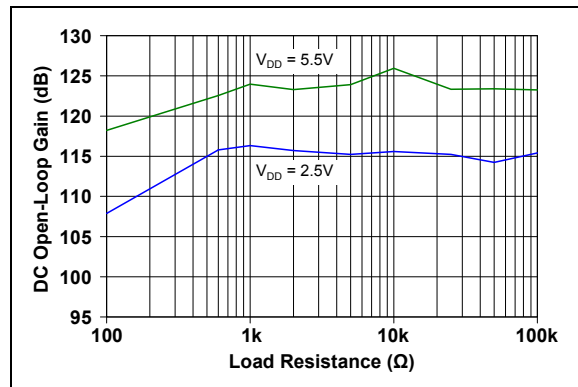

FIGURE 2-11: DC Open-Loop Gain vs. Load Resistance.

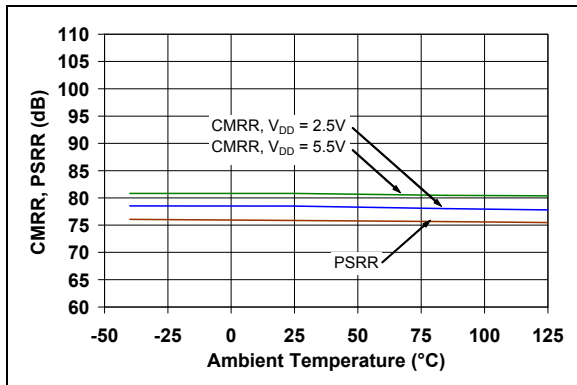

FIGURE 2-9: CMRR and PSRR vs. Ambient Temperature.

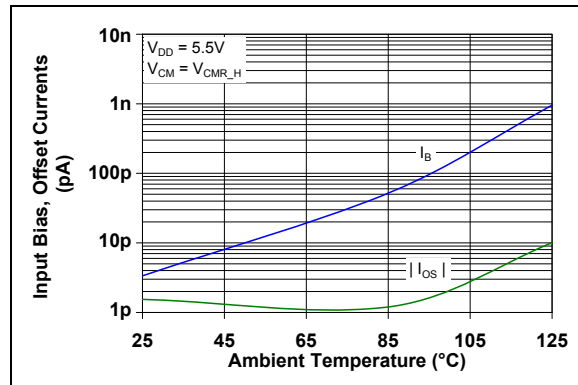

FIGURE 2-12: Input Bias and Offset Currents vs. Ambient Temperature with $V_{DD} = +5.5\text{V}$.

Note: Unless otherwise indicated, $T_A = +25^\circ\text{C}$, $V_{DD} = +2.5\text{V}$ to 5.5V , $V_{SS} = \text{GND}$, $V_{CM} = V_{DD}/3$, $V_{OUT} = V_{DD}/2$, $V_L = V_{DD}/2$, $R_L = 2\text{ k}\Omega$ to V_L , $C_L = 50\text{ pF}$ and $\overline{CS} = V_{SS}$.

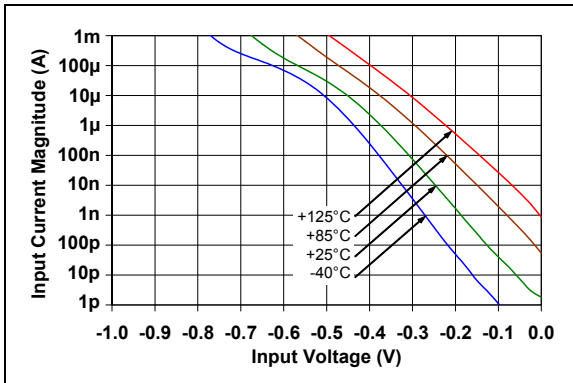

FIGURE 2-13: Input Bias Current vs. Input Voltage (below V_{SS}).

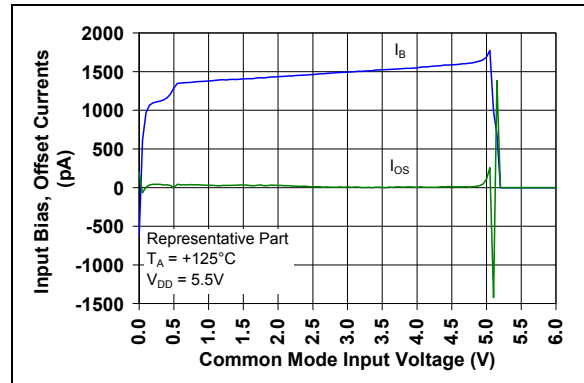

FIGURE 2-15: Input Bias and Offset Currents vs. Common Mode Input Voltage with $T_A = +125^\circ\text{C}$.

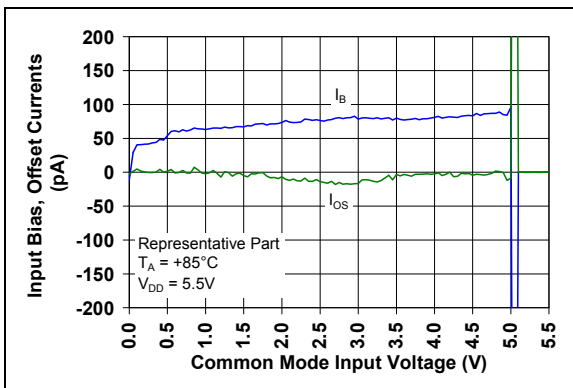

FIGURE 2-14: Input Bias and Offset Currents vs. Common Mode Input Voltage with $T_A = +85^\circ\text{C}$.

MCP631/2/3/5

Note: Unless otherwise indicated, $T_A = +25^\circ\text{C}$, $V_{DD} = +2.5\text{V}$ to 5.5V , $V_{SS} = \text{GND}$, $V_{CM} = V_{DD}/3$, $V_{OUT} = V_{DD}/2$, $V_L = V_{DD}/2$, $R_L = 2\text{ k}\Omega$ to V_L , $C_L = 50\text{ pF}$ and $\overline{CS} = V_{SS}$.

2.2 Other DC Voltages and Currents

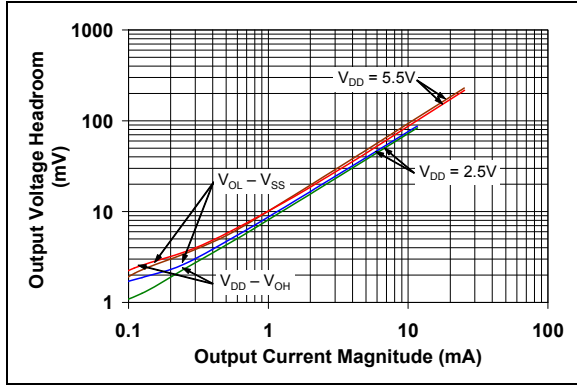

FIGURE 2-16: Output Voltage Headroom vs. Output Current.

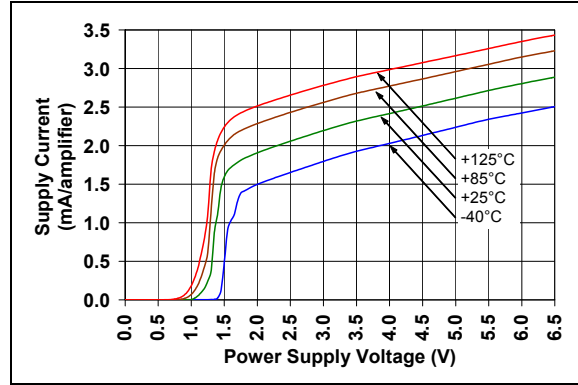

FIGURE 2-19: Supply Current vs. Power Supply Voltage.

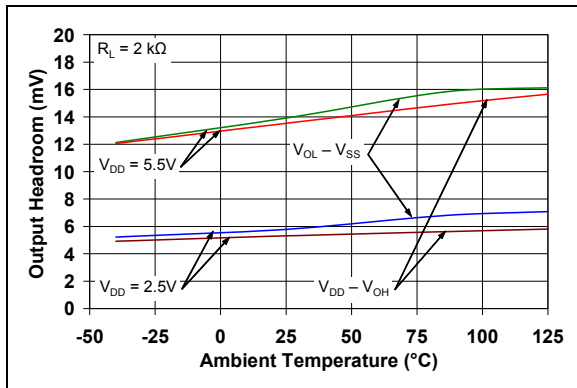

FIGURE 2-17: Output Voltage Headroom vs. Ambient Temperature.

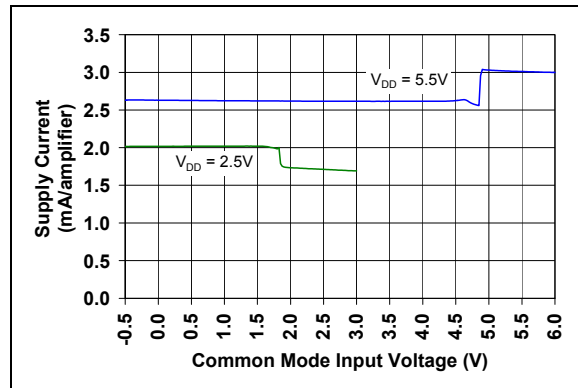

FIGURE 2-20: Supply Current vs. Common Mode Input Voltage.

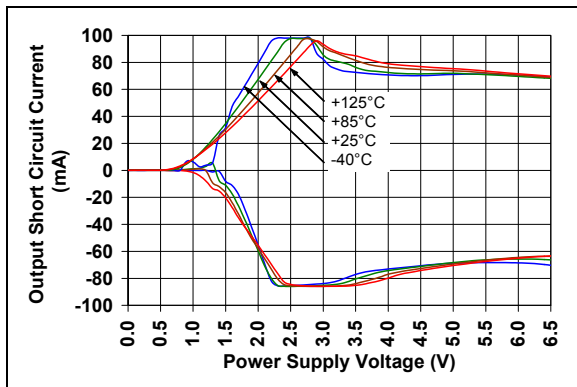

FIGURE 2-18: Output Short Circuit Current vs. Power Supply Voltage.

Note: Unless otherwise indicated, $T_A = +25^\circ\text{C}$, $V_{DD} = +2.5\text{V}$ to 5.5V , $V_{SS} = \text{GND}$, $V_{CM} = V_{DD}/3$, $V_{OUT} = V_{DD}/2$, $V_L = V_{DD}/2$, $R_L = 2\text{ k}\Omega$ to V_L , $C_L = 50\text{ pF}$ and $\overline{CS} = V_{SS}$.

2.3 Frequency Response

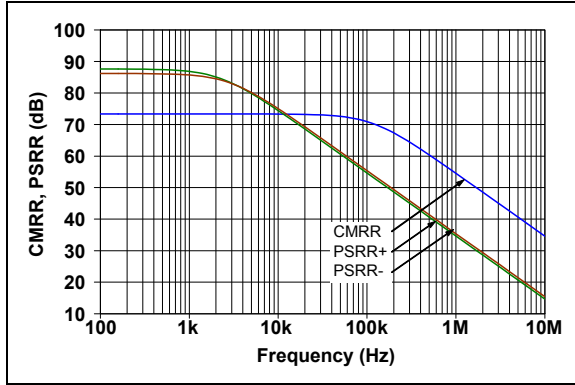

FIGURE 2-21: CMRR and PSRR vs. Frequency.

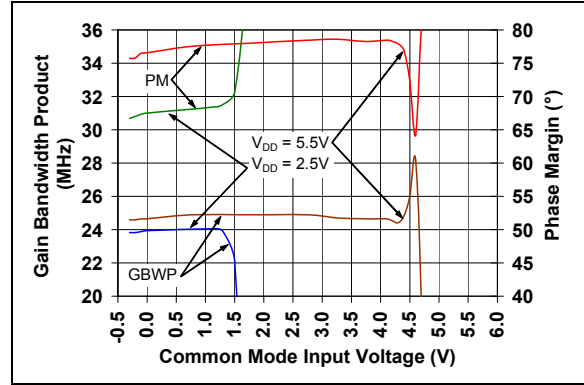

FIGURE 2-24: Gain Bandwidth Product and Phase Margin vs. Common Mode Input Voltage.

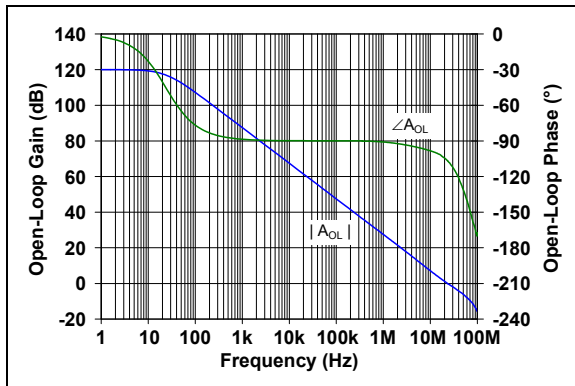

FIGURE 2-22: Open-Loop Gain vs. Frequency.

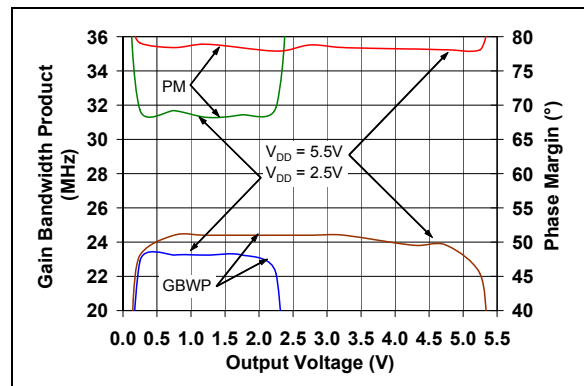

FIGURE 2-25: Gain Bandwidth Product and Phase Margin vs. Output Voltage.

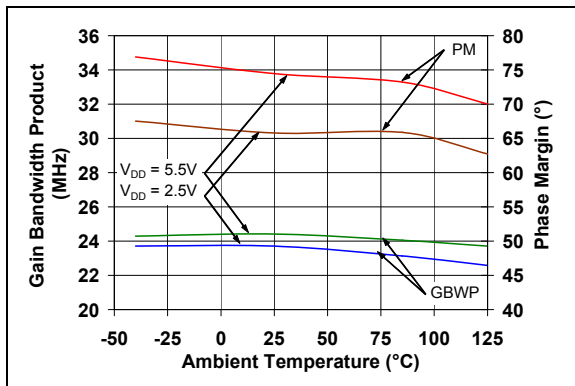

FIGURE 2-23: Gain Bandwidth Product and Phase Margin vs. Ambient Temperature.

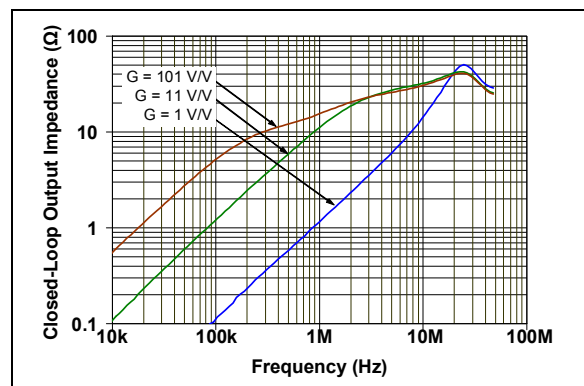

FIGURE 2-26: Closed-Loop Output Impedance vs. Frequency.

MCP631/2/3/5

Note: Unless otherwise indicated, $T_A = +25^\circ\text{C}$, $V_{DD} = +2.5\text{V}$ to 5.5V , $V_{SS} = \text{GND}$, $V_{CM} = V_{DD}/3$, $V_{OUT} = V_{DD}/2$, $V_L = V_{DD}/2$, $R_L = 2\text{ k}\Omega$ to V_L , $C_L = 50\text{ pF}$ and $\overline{CS} = V_{SS}$.

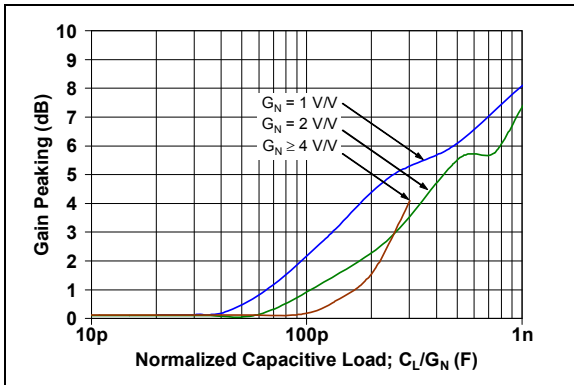

FIGURE 2-27: Gain Peaking vs. Normalized Capacitive Load.

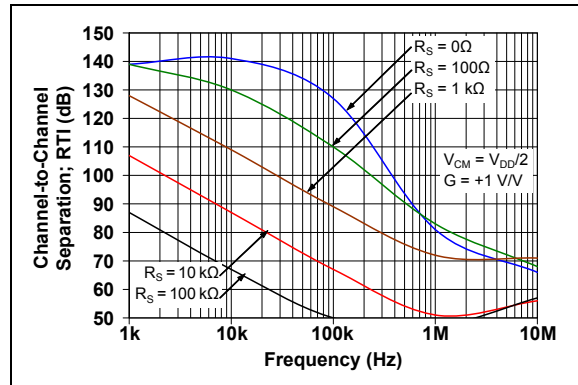

FIGURE 2-28: Channel-to-Channel Separation vs. Frequency.

Note: Unless otherwise indicated, $T_A = +25^\circ\text{C}$, $V_{DD} = +2.5\text{V}$ to 5.5V , $V_{SS} = \text{GND}$, $V_{CM} = V_{DD}/3$, $V_{OUT} = V_{DD}/2$, $V_L = V_{DD}/2$, $R_L = 2\text{ k}\Omega$ to V_L , $C_L = 50\text{ pF}$ and $\text{CS} = V_{SS}$.

2.4 Noise and Distortion

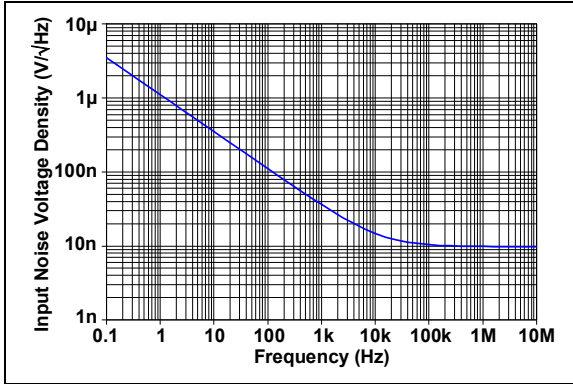

FIGURE 2-29: Input Noise Voltage Density vs. Frequency.

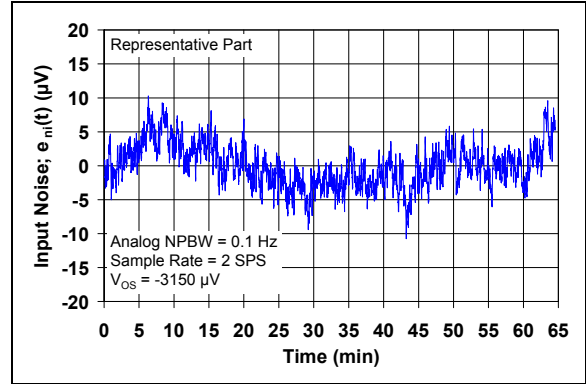

FIGURE 2-32: Input Noise vs. Time with 0.1 Hz Filter.

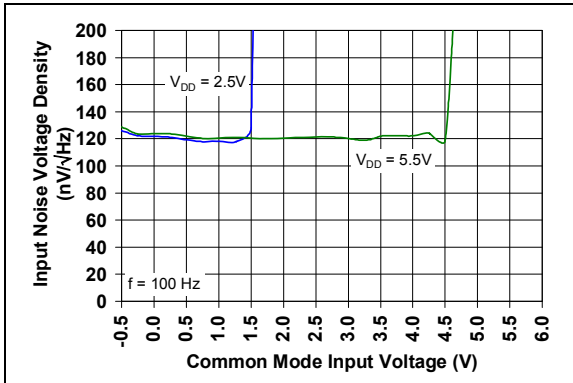

FIGURE 2-30: Input Noise Voltage Density vs. Input Common Mode Voltage with $f = 100\text{ Hz}$.

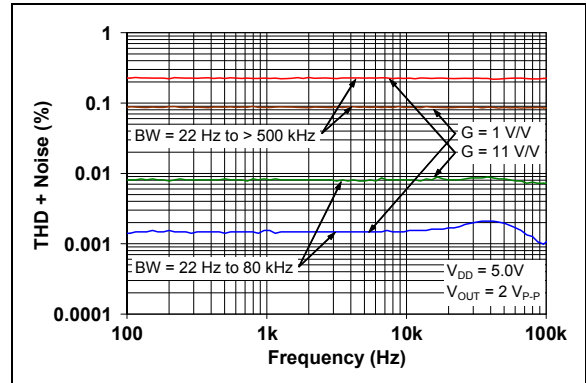

FIGURE 2-33: THD+N vs. Frequency.

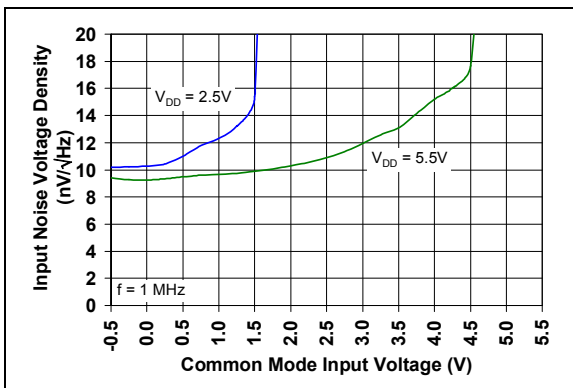

FIGURE 2-31: Input Noise Voltage Density vs. Input Common Mode Voltage with $f = 1\text{ MHz}$.

MCP631/2/3/5

Note: Unless otherwise indicated, $T_A = +25^\circ\text{C}$, $V_{DD} = +2.5\text{V}$ to 5.5V , $V_{SS} = \text{GND}$, $V_{CM} = V_{DD}/3$, $V_{OUT} = V_{DD}/2$, $V_L = V_{DD}/2$, $R_L = 2\text{ k}\Omega$ to V_L , $C_L = 50\text{ pF}$ and $\overline{\text{CS}} = V_{SS}$.

2.5 Time Response

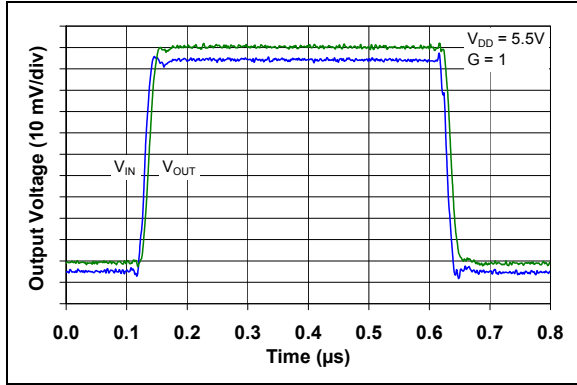

FIGURE 2-34: Non-inverting Small Signal Step Response.

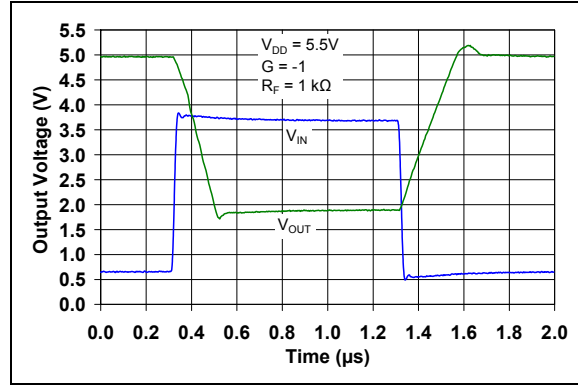

FIGURE 2-37: Inverting Large Signal Step Response.

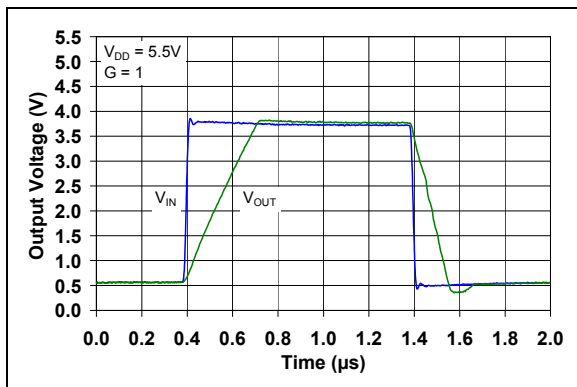

FIGURE 2-35: Non-inverting Large Signal Step Response.

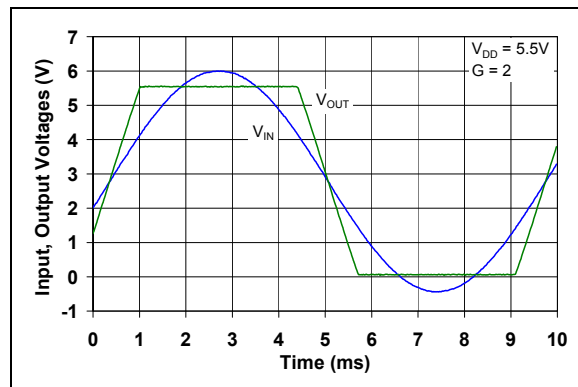

FIGURE 2-38: The MCP631/2/3/5 family shows no input phase reversal with overdrive.

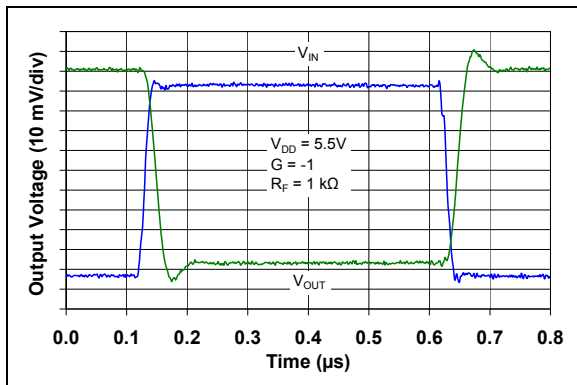

FIGURE 2-36: Inverting Small Signal Step Response.

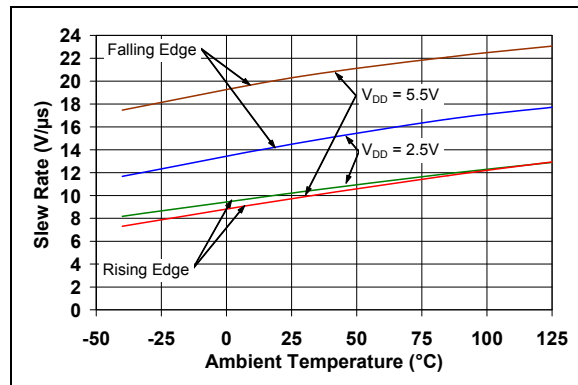

FIGURE 2-39: Slew Rate vs. Ambient Temperature.

Note: Unless otherwise indicated, $T_A = +25^\circ\text{C}$, $V_{DD} = +2.5\text{V}$ to 5.5V , $V_{SS} = \text{GND}$, $V_{CM} = V_{DD}/3$, $V_{OUT} = V_{DD}/2$, $V_L = V_{DD}/2$, $R_L = 2\text{ k}\Omega$ to V_L , $C_L = 50\text{ pF}$ and $\overline{CS} = V_{SS}$.

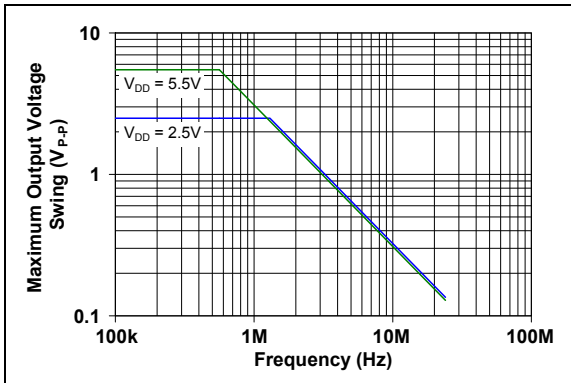

FIGURE 2-40: Maximum Output Voltage Swing vs. Frequency.

MCP631/2/3/5

Note: Unless otherwise indicated, $T_A = +25^\circ\text{C}$, $V_{DD} = +2.5\text{V}$ to 5.5V , $V_{SS} = \text{GND}$, $V_{CM} = V_{DD}/3$, $V_{OUT} = V_{DD}/2$, $V_L = V_{DD}/2$, $R_L = 2\text{ k}\Omega$ to V_L , $C_L = 50\text{ pF}$ and $\overline{\text{CS}} = V_{SS}$.

2.6 Chip Select Response

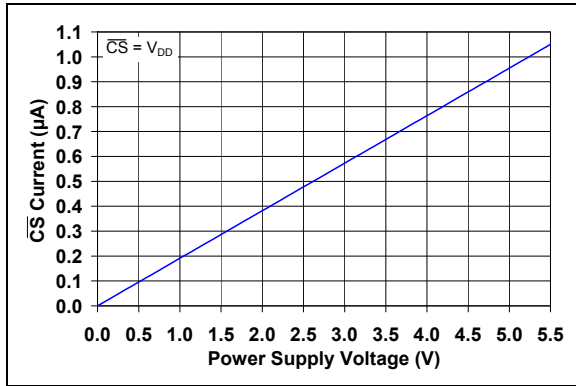

FIGURE 2-41: $\overline{\text{CS}}$ Current vs. Power Supply Voltage.

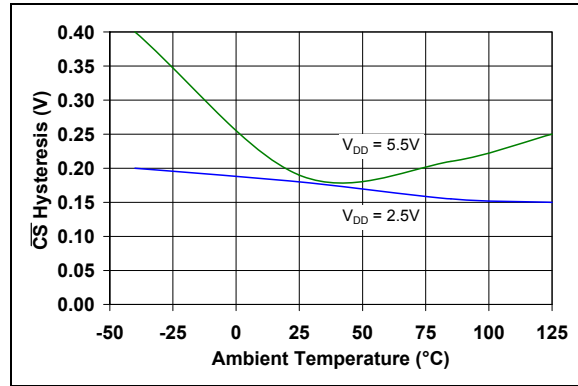

FIGURE 2-44: $\overline{\text{CS}}$ Hysteresis vs. Ambient Temperature.

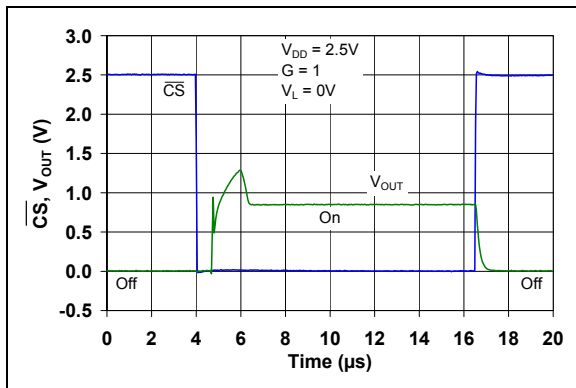

FIGURE 2-42: $\overline{\text{CS}}$ and Output Voltages vs. Time with $V_{DD} = 2.5\text{V}$.

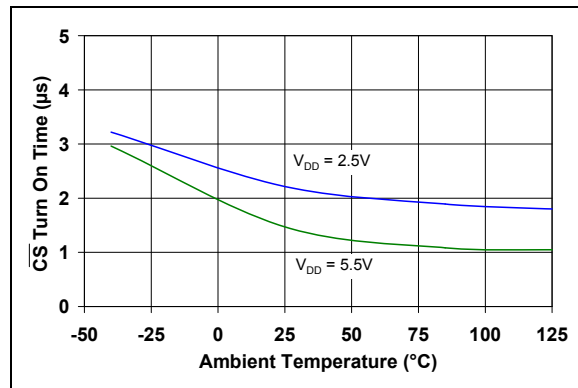

FIGURE 2-45: $\overline{\text{CS}}$ Turn On Time vs. Ambient Temperature.

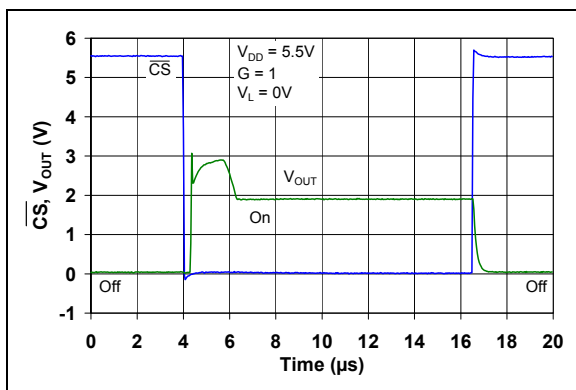

FIGURE 2-43: $\overline{\text{CS}}$ and Output Voltages vs. Time with $V_{DD} = 5.5\text{V}$.

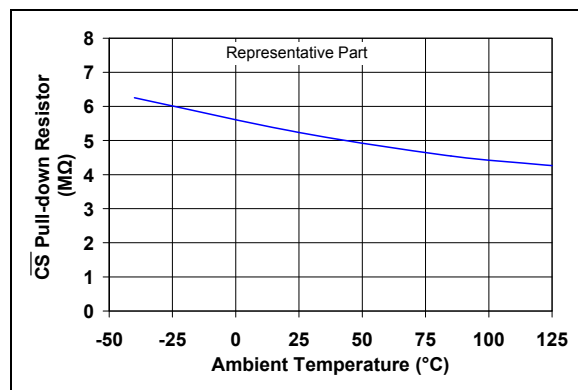

FIGURE 2-46: $\overline{\text{CS}}$'s Pull-down Resistor (R_{PD}) vs. Ambient Temperature.

Note: Unless otherwise indicated, $T_A = +25^\circ\text{C}$, $V_{DD} = +2.5\text{V}$ to 5.5V , $V_{SS} = \text{GND}$, $V_{CM} = V_{DD}/3$, $V_{OUT} = V_{DD}/2$, $V_L = V_{DD}/2$, $R_L = 2\text{ k}\Omega$ to V_L , $C_L = 50\text{ pF}$ and $\overline{\text{CS}} = V_{SS}$.

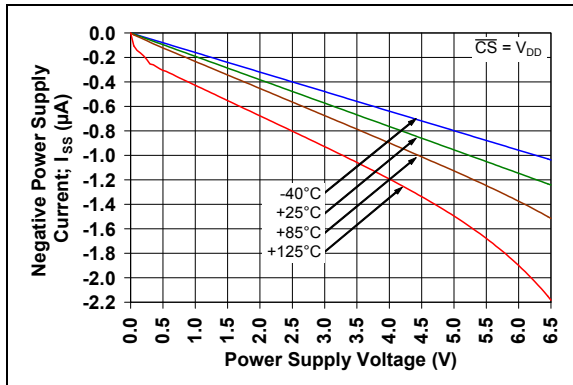

FIGURE 2-47: Quiescent Current in Shutdown vs. Power Supply Voltage.

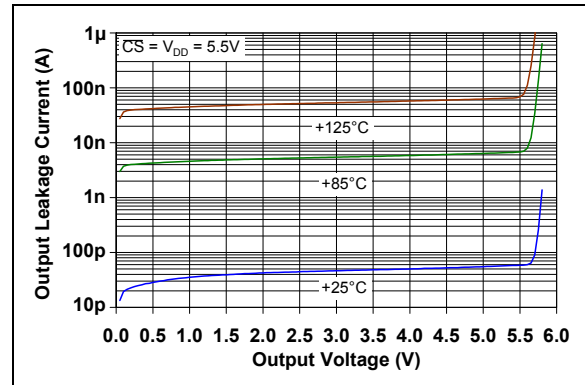

FIGURE 2-48: Output Leakage Current vs. Output Voltage.

MCP631/2/3/5

NOTES:

3.0 PIN DESCRIPTIONS

Descriptions of the pins are listed in [Table 3-1](#).

TABLE 3-1: PIN FUNCTION TABLE

| MCP631 | MCP632 | | MCP633 | MCP635 | | Symbol | Description |
|--------|--------|------|--------|--------|------|---------------------------------|---|
| | SOIC | SOIC | | DFN | MSOP | | |
| 6 | 1 | 1 | 6 | 1 | 1 | V_{OUT}, V_{OUTA} | Output (op amp A) |
| 2 | 2 | 2 | 2 | 2 | 2 | V_{IN-}, V_{INA-} | Inverting Input (op amp A) |
| 3 | 3 | 3 | 3 | 3 | 3 | V_{IN+}, V_{INA+} | Non-inverting Input (op amp A) |
| 4 | 4 | 4 | 4 | 4 | 4 | V_{SS} | Negative Power Supply |
| — | — | — | 8 | 5 | 5 | $\overline{CS}, \overline{CSA}$ | Chip Select Digital Input (op amp A) |
| — | — | — | — | 6 | 6 | \overline{CSB} | Chip Select Digital Input (op amp B) |
| — | 5 | 5 | — | 7 | 7 | V_{INB+} | Non-inverting Input (op amp B) |
| — | 6 | 6 | — | 8 | 8 | V_{INB-} | Inverting Input (op amp B) |
| — | 7 | 7 | — | 9 | 9 | V_{OUTB} | Output (op amp B) |
| 7 | 8 | 8 | 7 | 10 | 10 | V_{DD} | Positive Power Supply |
| 1,5,8 | — | — | 1,5 | — | — | NC | No Internal Connection |
| — | — | 9 | — | — | 11 | EP | Exposed Thermal Pad (EP); must be connected to V_{SS} |

3.1 Analog Outputs

The analog output pins (V_{OUT}) are low-impedance voltage sources.

3.2 Analog Inputs

The non-inverting and inverting inputs (V_{IN+}, V_{IN-}, \dots) are high-impedance CMOS inputs with low bias currents.

3.3 Power Supply Pins

The positive power supply (V_{DD}) is 2.5V to 5.5V higher than the negative power supply (V_{SS}). For normal operation, the other pins are between V_{SS} and V_{DD} .

Typically, these parts are used in a single (positive) supply configuration. In this case, V_{SS} is connected to ground and V_{DD} is connected to the supply. V_{DD} will need bypass capacitors.

3.4 Chip Select Digital Input (\overline{CS})

This input (\overline{CS}) is a CMOS, Schmitt-triggered input that places the part into a low power mode of operation.

3.5 Exposed Thermal Pad (EP)

There is an internal connection between the Exposed Thermal Pad (EP) and the V_{SS} pin; they must be connected to the same potential on the Printed Circuit Board (PCB).

This pad can be connected to a PCB ground plane to provide a larger heat sink. This improves the package thermal resistance (θ_{JA}).

MCP631/2/3/5

NOTES:

4.0 APPLICATIONS

The MCP631/2/3/5 family op amps is manufactured using Microchip's state of the art CMOS process. It is designed for low cost, low power and high speed applications. Its low supply voltage, low quiescent current and wide bandwidth make the MCP631/2/3/5 ideal for battery-powered applications.

4.1 Input

4.1.1 PHASE REVERSAL

The input devices are designed to not exhibit phase inversion when the input pins exceed the supply voltages. [Figure 2-38](#) shows an input voltage exceeding both supplies with no phase inversion.

4.1.2 INPUT VOLTAGE AND CURRENT LIMITS

The ESD protection on the inputs can be depicted as shown in [Figure 4-1](#). This structure was chosen to protect the input transistors, and to minimize input bias current (I_B). The input ESD diodes clamp the inputs when they try to go more than one diode drop below V_{SS} . They also clamp any voltages that go too far above V_{DD} ; their breakdown voltage is high enough to allow normal operation, and low enough to bypass quick ESD events within the specified limits.

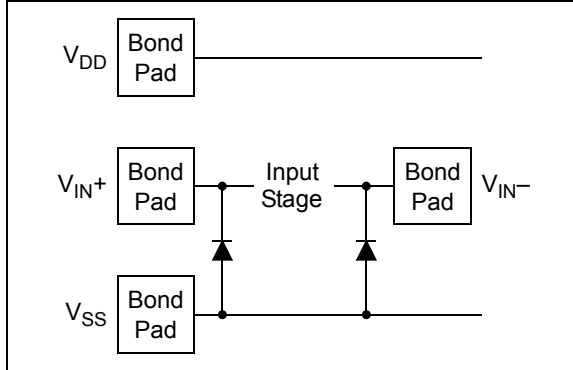

FIGURE 4-1: Simplified Analog Input ESD Structures.

In order to prevent damage and/or improper operation of these amplifiers, the circuit must limit the currents (and voltages) at the input pins (see [Section 1.1 "Absolute Maximum Ratings †"](#)). [Figure 4-2](#) shows the recommended approach to protecting these inputs. The internal ESD diodes prevent the input pins (V_{IN+} and V_{IN-}) from going too far below ground, and the resistors R_1 and R_2 limit the possible current drawn out of the input pins. Diodes D_1 and D_2 prevent the input pins (V_{IN+} and V_{IN-}) from going too far above V_{DD} , and dump any currents onto V_{DD} . When implemented as shown, resistors R_1 and R_2 also limit the current through D_1 and D_2 .

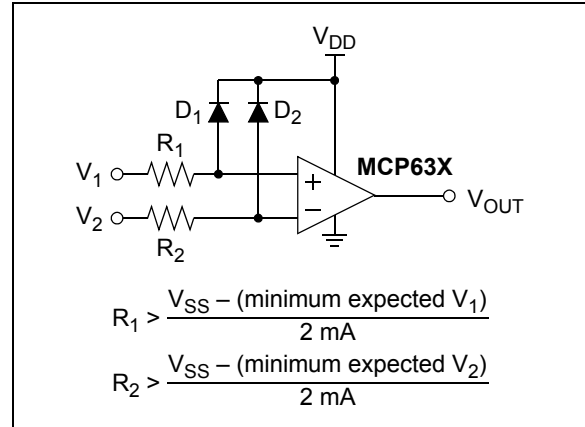

FIGURE 4-2: Protecting the Analog Inputs.

It is also possible to connect the diodes to the left of the resistor R_1 and R_2 . In this case, the currents through the diodes D_1 and D_2 need to be limited by some other mechanism. The resistors then serve as in-rush current limiters; the DC current into the input pins (V_{IN+} and V_{IN-}) should be very small.

A significant amount of current can flow out of the inputs (through the ESD diodes) when the common mode voltage (V_{CM}) is below ground (V_{SS}); see [Figure 2-13](#). Applications that are high impedance may need to limit the usable voltage range.

4.1.3 NORMAL OPERATION

The input stage of the MCP631/2/3/5 op amps uses a differential PMOS input stage. It operates at low common mode input voltages (V_{CM}), with V_{CM} between $V_{SS} - 0.3V$ and $V_{DD} - 1.3V$. To ensure proper operation, the input offset voltage (V_{OS}) is measured at both $V_{CM} = V_{SS} - 0.3V$ and $V_{DD} - 1.3V$. See [Figure 2-5](#) and [Figure 2-6](#) for temperature effects.

When operating at very low non-inverting gains, the output voltage is limited at the top by the V_{CM} range ($< V_{DD} - 1.3V$); see [Figure 4-3](#).

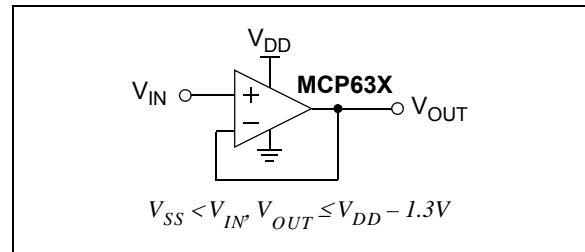

FIGURE 4-3: Unity Gain Voltage Limitations for Linear Operation.

MCP631/2/3/5

4.2 Rail-to-Rail Output

4.2.1 MAXIMUM OUTPUT VOLTAGE

The Maximum Output Voltage (see Figure 2-16 and Figure 2-17) describes the output range for a given load. For instance, the output voltage swings to within 50 mV of the negative rail with a 1 kΩ load tied to $V_{DD}/2$.

4.2.2 OUTPUT CURRENT

Figure 4-4 shows the possible combinations of output voltage (V_{OUT}) and output current (I_{OUT}), when $V_{DD} = 5.5V$. I_{OUT} is positive when it flows out of the op amp into the external circuit.

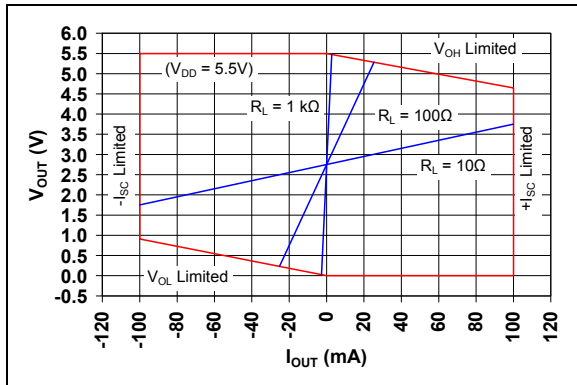

FIGURE 4-4: Output Current.

4.2.3 POWER DISSIPATION

Since the output short circuit current (I_{SC}) is specified at ± 70 mA (typical), these op amps are capable of both delivering and dissipating significant power.

Figure 4-5 show the quantities used in the following power calculations for a single op amp. R_{SER} is 0 Ω in most applications; it can be used to limit I_{OUT} . V_{OUT} is the op amp's output voltage, V_L is the voltage at the load, and V_{LG} is the load's ground point. V_{SS} is usually ground (0V). The input currents are assumed to be negligible. The currents shown are approximately:

EQUATION 4-1:

$$I_{OUT} = I_L = \frac{V_{OUT} - V_{LG}}{R_{SER} + R_L}$$

$$I_{DD} \approx I_Q + \max(0, I_{OUT})$$

$$I_{SS} \approx -I_Q + \min(0, I_{OUT})$$

Where:

$$I_Q = \text{quiescent supply current}$$

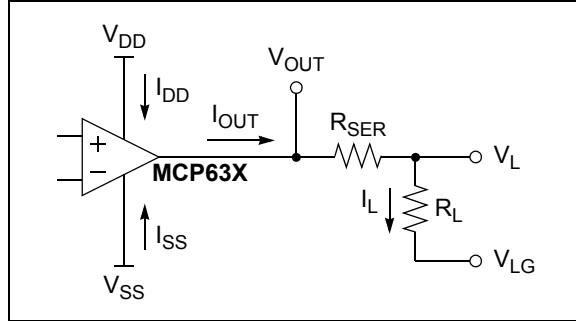

FIGURE 4-5: Diagram for Power Calculations.

The instantaneous op amp power ($P_{OA}(t)$), R_{SER} power ($P_{RSER}(t)$) and load power ($P_L(t)$) are:

EQUATION 4-2:

$$P_{OA}(t) = I_{DD}(V_{DD} - V_{OUT}) + I_{SS}(V_{SS} - V_{OUT})$$

$$P_{RSER}(t) = I_{OUT}^2 R_{SER}$$

$$P_L(t) = I_L^2 R_L$$

The maximum op amp power, for resistive loads, occurs when V_{OUT} is halfway between V_{DD} and V_{LG} or halfway between V_{SS} and V_{LG} :

EQUATION 4-3:

$$P_{OAm} \leq \frac{\max^2(V_{DD} - V_{LG}, V_{LG} - V_{SS})}{4(R_{SER} + R_L)}$$

The maximum ambient to junction temperature rise (ΔT_{JA}) and junction temperature (T_J) can be calculated using P_{OAm} , ambient temperature (T_A), the package thermal resistance (θ_{JA}) found in Table 1-4, and the number of op amps in the package (assuming equal power dissipations):

EQUATION 4-4:

$$\Delta T_{JA} = P_{OA}(t) \theta_{JA} \leq n P_{OAm} \theta_{JA}$$

$$T_J = T_A + \Delta T_{JA}$$

Where:

$$n = \text{number of op amps in package (1, 2)}$$

The power de-rating across temperature for an op amp in a particular package can be easily calculated (assuming equal power dissipations):

EQUATION 4-5:

$$P_{OAmax} \leq \frac{T_{Jmax} - T_A}{n \theta_{JA}}$$

Where:
 T_{Jmax} = absolute maximum junction temperature

Several techniques are available to reduce ΔT_{JA} for a given P_{OAmax} :

- Lower θ_{JA}
 - Use another package
 - PCB layout (ground plane, etc.)
 - Heat sinks and air flow
- Reduce P_{OAmax}
 - Increase R_L
 - Limit I_{OUT} (using R_{SER})
 - Decrease V_{DD}

4.3 Improving Stability

4.3.1 CAPACITIVE LOADS

Driving large capacitive loads can cause stability problems for voltage feedback op amps. As the load capacitance increases, the feedback loop's phase margin decreases and the closed-loop bandwidth is reduced. This produces gain peaking in the frequency response, with overshoot and ringing in the step response. A unity gain buffer ($G = +1$) is the most sensitive to capacitive loads, though all gains show the same general behavior.

When driving large capacitive loads with these op amps (e.g., > 20 pF when $G = +1$), a small series resistor at the output (R_{ISO} in Figure 4-6) improves the feedback loop's phase margin (stability) by making the output load resistive at higher frequencies. The bandwidth will be generally lower than the bandwidth with no capacitive load.

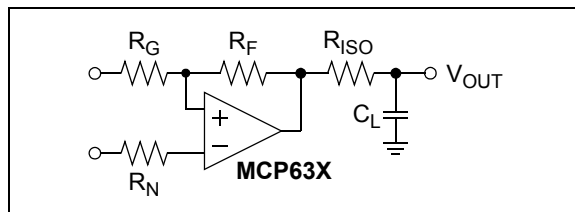

FIGURE 4-6: Output Resistor, R_{ISO} stabilizes large capacitive loads.

Figure 4-7 gives recommended R_{ISO} values for different capacitive loads and gains. The x-axis is the normalized load capacitance (C_L/G_N), where G_N is the circuit's noise gain. For non-inverting gains, G_N and the Signal Gain are equal. For inverting gains, G_N is $1+|\text{Signal Gain}|$ (e.g., -1 V/V gives $G_N = +2$ V/V).

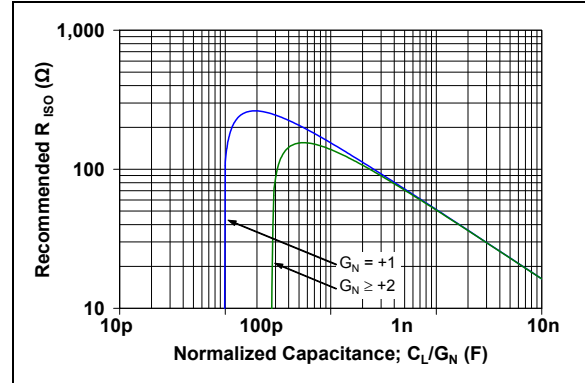

FIGURE 4-7: Recommended R_{ISO} Values for Capacitive Loads.

After selecting R_{ISO} for your circuit, double check the resulting frequency response peaking and step response overshoot. Modify R_{ISO} 's value until the response is reasonable. Bench evaluation and simulations with the MCP631/2/3/5 SPICE macro model are helpful.

4.3.2 GAIN PEAKING

Figure 4-8 shows an op amp circuit that represents non-inverting amplifiers (V_M is a DC voltage and V_P is the input) or inverting amplifiers (V_P is a DC voltage and V_M is the input). The capacitances C_N and C_G represent the total capacitance at the input pins; they include the op amp's common mode input capacitance (C_{CM}), board parasitic capacitance and any capacitor placed in parallel.

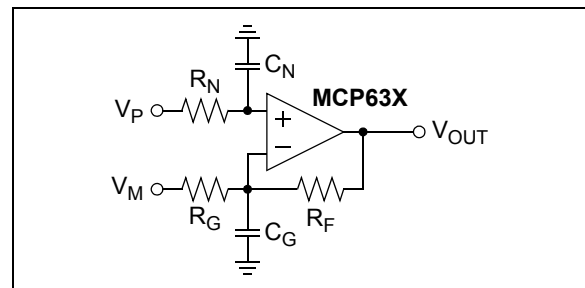

FIGURE 4-8: Amplifier with Parasitic Capacitance.

C_G acts in parallel with R_G (except for a gain of $+1$ V/V), which causes an increase in gain at high frequencies. C_G also reduces the phase margin of the feedback loop, which becomes less stable. This effect can be reduced by either reducing C_G or R_F .

MCP631/2/3/5

C_N and R_N form a low-pass filter that affects the signal at V_P . This filter has a single real pole at $1/(2\pi R_N C_N)$.

The largest value of R_F that should be used depends on noise gain (see G_N in **Section 4.3.1 “Capacitive Loads”**), C_G and the open-loop gain's phase shift. **Figure 4-9** shows the maximum recommended R_F for several C_G values. Some applications may modify these values to reduce either output loading or gain peaking (step response overshoot).

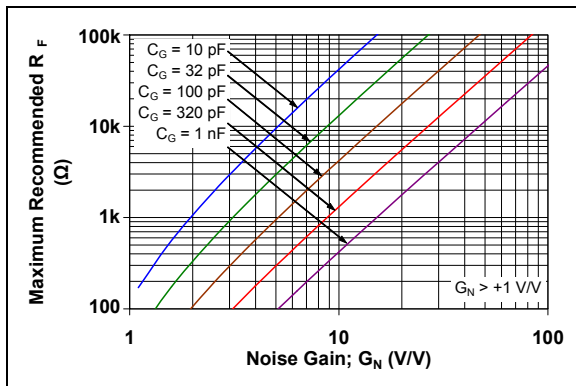

FIGURE 4-9: Maximum Recommended R_F vs. Gain.

Figure 2-34 and **Figure 2-35** show the small signal and large signal step responses at $G = +1$ V/V. The unity gain buffer usually has $R_F = 0\Omega$ and R_G open.

Figure 2-36 and **Figure 2-37** show the small signal and large signal step responses at $G = -1$ V/V. Since the noise gain is 2 V/V and $C_G \approx 10$ pF, the resistors were chosen to be $R_F = R_G = 1$ k Ω and $R_N = 500\Omega$.

It is also possible to add a capacitor (C_F) in parallel with R_F to compensate for the de-stabilizing effect of C_G . This makes it possible to use larger values of R_F . The conditions for stability are summarized in **Equation 4-6**.

EQUATION 4-6:

Given:

$$G_{N1} = 1 + R_F/R_G$$

$$G_{N2} = 1 + C_G/C_F$$

$$f_F = 1/(2\pi R_F C_F)$$

$$f_Z = f_F(G_{N1}/G_{N2})$$

We need:

$$f_F \leq f_{GBWP}/(2G_{N2}), \quad G_{N1} < G_{N2}$$

$$f_F \leq f_{GBWP}/(4G_{N1}), \quad G_{N1} > G_{N2}$$

4.4 MCP633 and MCP635 Chip Select

The MCP633 is a single amplifier with Chip Select (\overline{CS}). When \overline{CS} is pulled high, the supply current drops to 1 μ A (typical) and flows through the \overline{CS} pin to V_{SS} . When this happens, the amplifier output is put into a high-impedance state. By pulling \overline{CS} low, the amplifier is enabled. The \overline{CS} pin has an internal 5 M Ω (typical) pulldown resistor connected to V_{SS} , so it will go low if the \overline{CS} pin is left floating. **Figure 1-1**, **Figure 2-42** and **Figure 2-43** show the output voltage and supply current response to a \overline{CS} pulse.

The MCP635 is a dual amplifier with two \overline{CS} pins; \overline{CSA} controls op amp A and \overline{CSB} controls op amp B. These op amps are controlled independently, with an enabled quiescent current (I_Q) of 2.5 mA/amplifier (typical) and a disabled I_Q of 1 μ A/amplifier (typical). The I_Q seen at the supply pins is the sum of the two op amps' I_Q ; the typical value for the MCP635's I_Q will be 2 μ A, 2.5 mA or 5 mA when there are 0, 1 or 2 amplifiers enabled, respectively.

4.5 Power Supply

With this family of operational amplifiers, the power supply pin (V_{DD} for single supply) should have a local bypass capacitor (i.e., 0.01 μ F to 0.1 μ F) within 2 mm for good high frequency performance. Surface mount, multilayer ceramic capacitors, or their equivalent, should be used.

These op amps require a bulk capacitor (i.e., 2.2 μ F or larger) within 50 mm to provide large, slow currents. Tantalum capacitors, or their equivalent, may be a good choice. This bulk capacitor can be shared with other nearby analog parts as long as crosstalk through the supplies does not prove to be a problem.

4.6 High Speed PCB Layout

These op amps are fast enough that a little extra care in the PCB (Printed Circuit Board) layout can make a significant difference in performance. Good PC board layout techniques will help you achieve the performance shown in the specifications and Typical Performance Curves; it will also help you minimize EMC (Electro-Magnetic Compatibility) issues.

Use a solid ground plane. Connect the bypass local capacitor(s) to this plane with minimal length traces. This cuts down inductive and capacitive crosstalk.

Separate digital from analog, low speed from high speed, and low power from high power. This will reduce interference.

Keep sensitive traces short and straight. Separate them from interfering components and traces. This is especially important for high frequency (low rise time) signals.

Sometimes, it helps to place guard traces next to victim traces. They should be on both sides of the victim trace, and as close as possible. Connect guard traces to ground plane at both ends, and in the middle for long traces.

Use coax cables, or low inductance wiring, to route signal and power to and from the PCB. Mutual and self inductance of power wires is often a cause of crosstalk and unusual behavior.

4.7 Typical Applications

4.7.1 POWER DRIVER WITH HIGH GAIN

Figure 4-10 shows a power driver with high gain ($1 + R_2/R_1$). The MCP631/2/3/5 op amp's short circuit current makes it possible to drive significant loads. The calibrated input offset voltage supports accurate response at high gains. R_3 should be small, and equal to $R_1 || R_2$, in order to minimize the bias current induced offset.

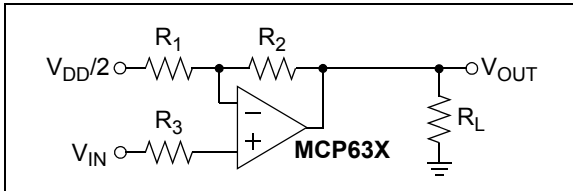

FIGURE 4-10: Power Driver.

4.7.2 OPTICAL DETECTOR AMPLIFIER

Figure 4-11 shows a transimpedance amplifier, using the MCP63X op amp, in a photo detector circuit. The photo detector is a capacitive current source. R_F provides enough gain to produce 10 mV at V_{OUT} . C_F stabilizes the gain and limits the transimpedance bandwidth to about 1.1 MHz. R_F 's parasitic capacitance (e.g., 0.2 pF for a 0805 SMD) acts in parallel with C_F .

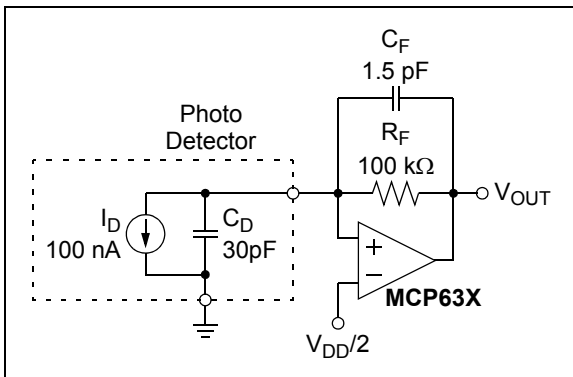

FIGURE 4-11: Transimpedance Amplifier for an Optical Detector.

4.7.3 H-BRIDGE DRIVER

Figure 4-12 shows the MCP632 dual op amp used as a H-bridge driver. The load could be a speaker or a DC motor.

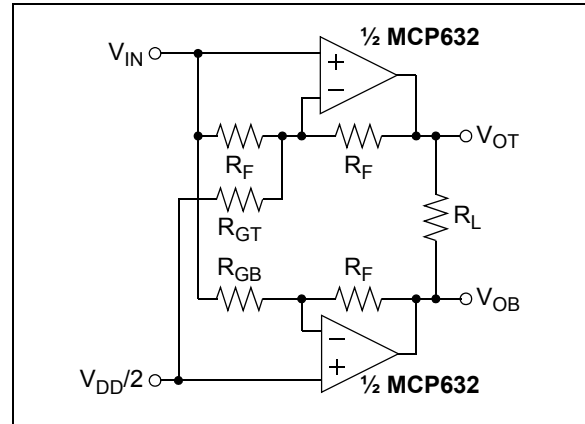

FIGURE 4-12: H-Bridge Driver.

This circuit automatically makes the noise gains (G_N) equal, when the gains are set properly, so that the frequency responses match well (in magnitude and in phase). Equation 4-7 shows how to calculate R_{GT} and R_{GB} so that both op amps have the same DC gains; G_{DM} needs to be selected first.

EQUATION 4-7:

$$G_{DM} \equiv \frac{V_{OT} - V_{OB}}{V_{IN} - V_{DD}/2} \geq 1 \text{ V/V}$$

$$R_{GT} = \frac{R_F}{(G_{DM}/2) - 1}$$

$$R_{GB} = \frac{R_F}{G_{DM}/2}$$

Equation 4-8 gives the resulting common mode and differential mode output voltages.

EQUATION 4-8:

$$\frac{V_{OT} + V_{OB}}{2} = \frac{V_{DD}}{2}$$

$$V_{OT} - V_{OB} = G_{DM} \left(V_{IN} - \frac{V_{DD}}{2} \right)$$

MCP631/2/3/5

NOTES:

5.0 DESIGN AIDS

Microchip provides the basic design aids needed for the MCP631/2/3/5 family of op amps.

5.1 SPICE Macro Model

The latest SPICE macro model for the MCP631/2/3/5 op amps is available on the Microchip web site at www.microchip.com. This model is intended to be an initial design tool that works well in the op amp's linear region of operation over the temperature range. See the model file for information on its capabilities.

Bench testing is a very important part of any design and cannot be replaced with simulations. Also, simulation results using this macro model need to be validated by comparing them to the data sheet specifications and characteristic curves.

5.2 FilterLab[®] Software

Microchip's FilterLab[®] software is an innovative software tool that simplifies analog active filter (using op amps) design. Available at no cost from the Microchip web site at www.microchip.com/filterlab, the Filter-Lab design tool provides full schematic diagrams of the filter circuit with component values. It also outputs the filter circuit in SPICE format, which can be used with the macro model to simulate actual filter performance.

5.3 Mindi[™] Circuit Designer & Simulator

Microchip's Mindi[™] Circuit Designer & Simulator aids in the design of various circuits useful for active filter, amplifier and power management applications. It is a free online circuit designer & simulator available from the Microchip web site at www.microchip.com/mindi. This interactive circuit designer & simulator enables designers to quickly generate circuit diagrams, and simulate circuits. Circuits developed using the Mindi Circuit Designer & Simulator can be downloaded to a personal computer or workstation.

5.4 Microchip Advanced Part Selector (MAPS)

MAPS is a software tool that helps efficiently identify Microchip devices that fit a particular design requirement. Available at no cost from the Microchip website at www.microchip.com/maps, the MAPS is an overall selection tool for Microchip's product portfolio that includes Analog, Memory, MCUs and DSCs. Using this tool, a customer can define a filter to sort features for a parametric search of devices and export side-by-side technical comparison reports. Helpful links are also provided for Data sheets, Purchase and Sampling of Microchip parts.

5.5 Analog Demonstration and Evaluation Boards

Microchip offers a broad spectrum of Analog Demonstration and Evaluation Boards that are designed to help customers achieve faster time to market. For a complete listing of these boards and their corresponding user's guides and technical information, visit the Microchip web site at [www.microchip.com/analog tools](http://www.microchip.com/analog%20tools).

Some boards that are especially useful are:

- MCP6XXX Amplifier Evaluation Board 1
- MCP6XXX Amplifier Evaluation Board 2
- MCP6XXX Amplifier Evaluation Board 3
- MCP6XXX Amplifier Evaluation Board 4
- Active Filter Demo Board Kit
- 8-Pin SOIC/MSOP/TSSOP/DIP Evaluation Board, P/N SOIC8EV

5.6 Application Notes

The following Microchip Application Notes are available on the Microchip web site at www.microchip.com/appnotes and are recommended as supplemental reference resources.

- **ADN003:** "Select the Right Operational Amplifier for your Filtering Circuits", DS21821
- **AN722:** "Operational Amplifier Topologies and DC Specifications", DS00722
- **AN723:** "Operational Amplifier AC Specifications and Applications", DS00723
- **AN884:** "Driving Capacitive Loads With Op Amps", DS00884
- **AN990:** "Analog Sensor Conditioning Circuits – An Overview", DS00990
- **AN1228:** "Op Amp Precision Design: Random Noise", DS01228

Some of these application notes, and others, are listed in the design guide:

- "Signal Chain Design Guide", DS21825

MCP631/2/3/5

NOTES:

6.0 PACKAGING INFORMATION

6.1 Package Marking Information

8-Lead DFN (3x3) (MCP632)

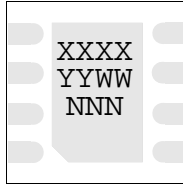

| Device | Code |
|--------|------|
| MCP632 | DABM |

Note: Applies to 8-Lead 3x3 DFN

Example

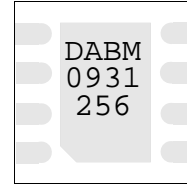

8-Lead SOIC (150 mil) (MCP631, MCP632, MCP633)

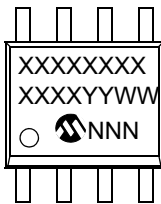

Example:

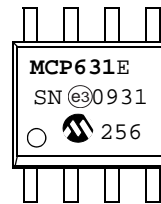

10-Lead DFN (3x3) (MCP635)

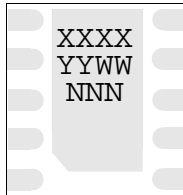

| Device | Code |
|--------|------|
| MCP635 | BAFB |

Note: Applies to 10-Lead 3x3 DFN

Example

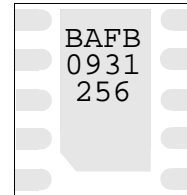

10-Lead MSOP (MCP635)

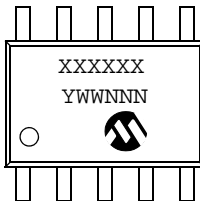

Example:

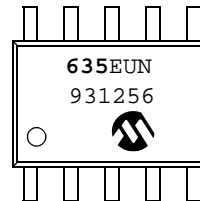

| | | |
|----------------|---|--|
| Legend: | XX...X | Customer-specific information |
| | Y | Year code (last digit of calendar year) |
| | YY | Year code (last 2 digits of calendar year) |
| | WW | Week code (week of January 1 is week '01') |
| | NNN | Alphanumeric traceability code |
| | | Pb-free JEDEC designator for Matte Tin (Sn) |
| | e3 | This package is Pb-free. The Pb-free JEDEC designator () can be found on the outer packaging for this package. e3 |
| Note: | In the event the full Microchip part number cannot be marked on one line, it will be carried over to the next line, thus limiting the number of available characters for customer-specific information. | |

MCP631/2/3/5

8-Lead Plastic Dual Flat, No Lead Package (MF) – 3x3x0.9 mm Body [DFN]

Note: For the most current package drawings, please see the Microchip Packaging Specification located at <http://www.microchip.com/packaging>

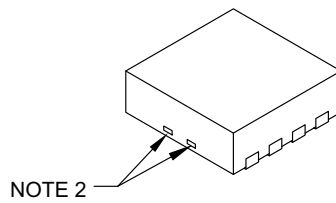
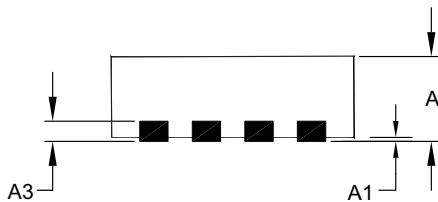
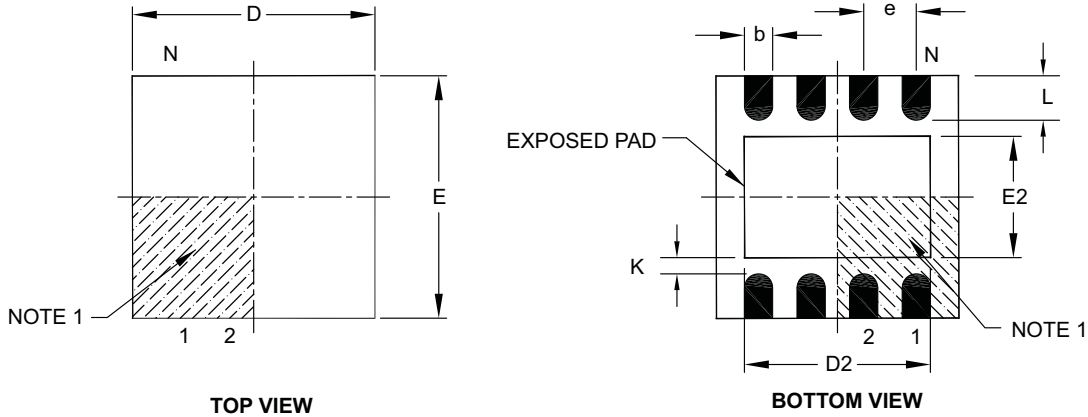

| Dimension Limits | Units | MILLIMETERS | | |
|------------------------|-------|-------------|------|------|
| | | MIN | NOM | MAX |
| Number of Pins | N | 8 | | |
| Pitch | e | 0.65 BSC | | |
| Overall Height | A | 0.80 | 0.90 | 1.00 |
| Standoff | A1 | 0.00 | 0.02 | 0.05 |
| Contact Thickness | A3 | 0.20 REF | | |
| Overall Length | D | 3.00 BSC | | |
| Exposed Pad Width | E2 | 0.00 | – | 1.60 |
| Overall Width | E | 3.00 BSC | | |
| Exposed Pad Length | D2 | 0.00 | – | 2.40 |
| Contact Width | b | 0.25 | 0.30 | 0.35 |
| Contact Length | L | 0.20 | 0.30 | 0.55 |
| Contact-to-Exposed Pad | K | 0.20 | – | – |

Notes:

- Pin 1 visual index feature may vary, but must be located within the hatched area.
- Package may have one or more exposed tie bars at ends.
- Package is saw singulated.
- Dimensioning and tolerancing per ASME Y14.5M.

BSC: Basic Dimension. Theoretically exact value shown without tolerances.

REF: Reference Dimension, usually without tolerance, for information purposes only.

Microchip Technology Drawing C04-062B

8-Lead Plastic Dual Flat, No Lead Package (MF) – 3x3x0.9 mm Body [DFN]

Note: For the most current package drawings, please see the Microchip Packaging Specification located at <http://www.microchip.com/packaging>

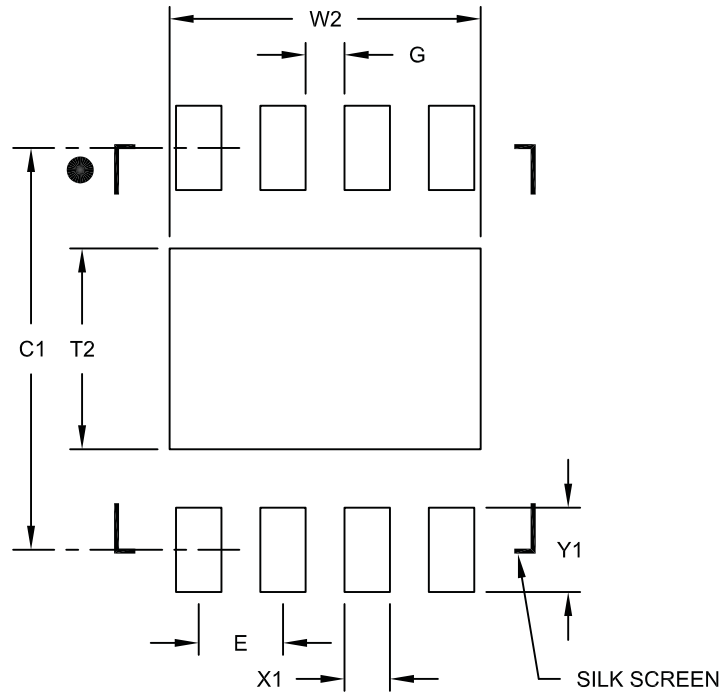

RECOMMENDED LAND PATTERN

| Dimension Limits | Units | MILLIMETERS | | |
|----------------------------|-------|-------------|------|------|
| | | MIN | NOM | MAX |
| Contact Pitch | E | 0.65 BSC | | |
| Optional Center Pad Width | W2 | | | 2.40 |
| Optional Center Pad Length | T2 | | | 1.55 |
| Contact Pad Spacing | C1 | | 3.10 | |
| Contact Pad Width (X8) | X1 | | | 0.35 |
| Contact Pad Length (X8) | Y1 | | | 0.65 |
| Distance Between Pads | G | 0.30 | | |

Notes:

1. Dimensioning and tolerancing per ASME Y14.5M

BSC: Basic Dimension. Theoretically exact value shown without tolerances.

Microchip Technology Drawing No. C04-2062A

MCP631/2/3/5

8-Lead Plastic Small Outline (SN) – Narrow, 3.90 mm Body [SOIC]

Note: For the most current package drawings, please see the Microchip Packaging Specification located at <http://www.microchip.com/packaging>

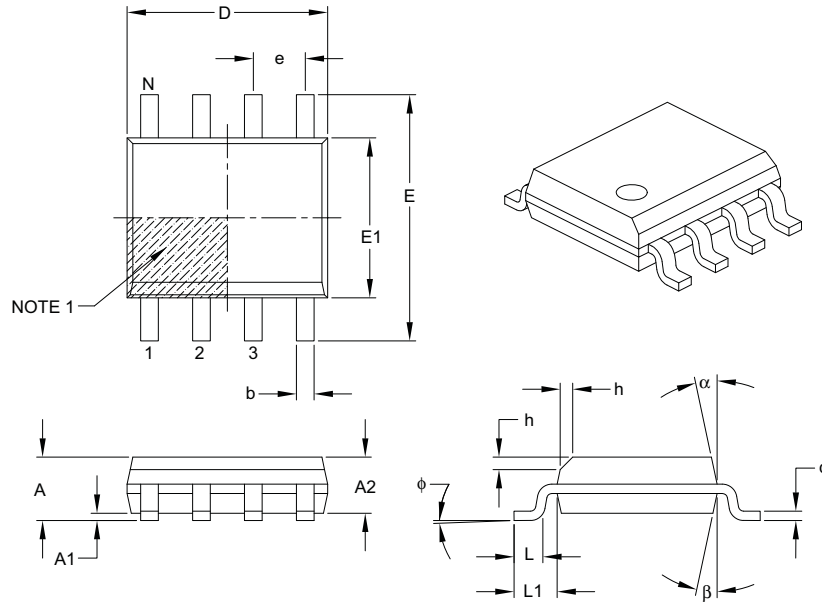

| Dimension Limits | Units | MILLIMETERS | | |
|--------------------------|----------|-------------|-----|------|
| | | MIN | NOM | MAX |
| Number of Pins | N | 8 | | |
| Pitch | e | 1.27 BSC | | |
| Overall Height | A | – | – | 1.75 |
| Molded Package Thickness | A2 | 1.25 | – | – |
| Standoff § | A1 | 0.10 | – | 0.25 |
| Overall Width | E | 6.00 BSC | | |
| Molded Package Width | E1 | 3.90 BSC | | |
| Overall Length | D | 4.90 BSC | | |
| Chamfer (optional) | h | 0.25 | – | 0.50 |
| Foot Length | L | 0.40 | – | 1.27 |
| Footprint | L1 | 1.04 REF | | |
| Foot Angle | ϕ | 0° | – | 8° |
| Lead Thickness | c | 0.17 | – | 0.25 |
| Lead Width | b | 0.31 | – | 0.51 |
| Mold Draft Angle Top | α | 5° | – | 15° |
| Mold Draft Angle Bottom | β | 5° | – | 15° |

Notes:

- Pin 1 visual index feature may vary, but must be located within the hatched area.
- § Significant Characteristic.
- Dimensions D and E1 do not include mold flash or protrusions. Mold flash or protrusions shall not exceed 0.15 mm per side.
- Dimensioning and tolerancing per ASME Y14.5M.

BSC: Basic Dimension. Theoretically exact value shown without tolerances.

REF: Reference Dimension, usually without tolerance, for information purposes only.

Microchip Technology Drawing C04-057B

8-Lead Plastic Small Outline (SN) – Narrow, 3.90 mm Body [SOIC]

Note: For the most current package drawings, please see the Microchip Packaging Specification located at <http://www.microchip.com/packaging>

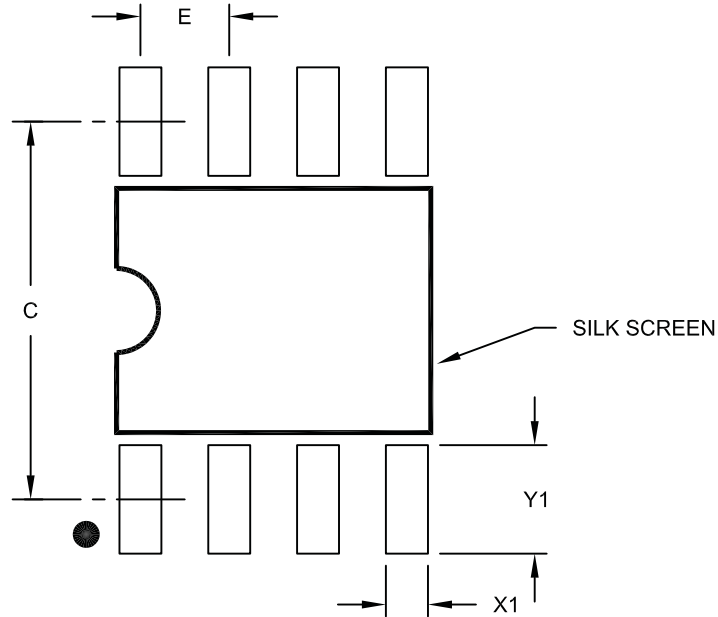

RECOMMENDED LAND PATTERN

| Dimension Limits | Units | MILLIMETERS | | |
|-------------------------|-------|-------------|------|------|
| | | MIN | NOM | MAX |
| Contact Pitch | E | 1.27 BSC | | |
| Contact Pad Spacing | C | | 5.40 | |
| Contact Pad Width (X8) | X1 | | | 0.60 |
| Contact Pad Length (X8) | Y1 | | | 1.55 |

Notes:

1. Dimensioning and tolerancing per ASME Y14.5M

BSC: Basic Dimension. Theoretically exact value shown without tolerances.

Microchip Technology Drawing No. C04-2057A

MCP631/2/3/5

10-Lead Plastic Dual Flat, No Lead Package (MF) – 3x3x0.9 mm Body [DFN]

Note: For the most current package drawings, please see the Microchip Packaging Specification located at <http://www.microchip.com/packaging>

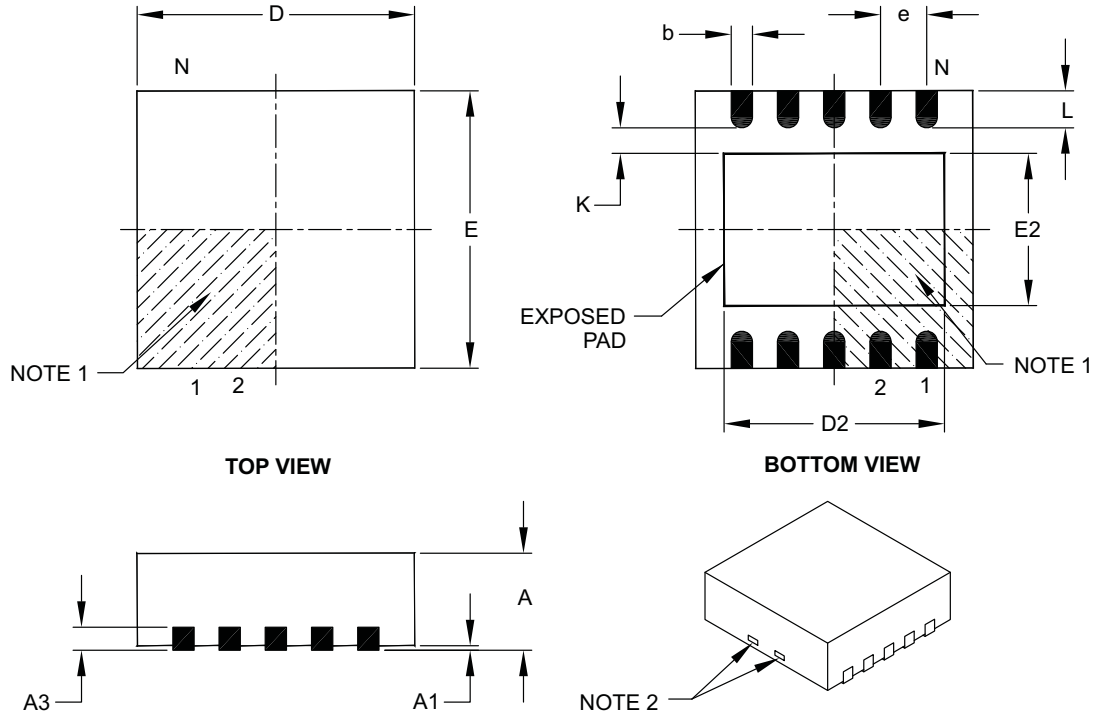

| Dimension Limits | Units | MILLIMETERS | | |
|------------------------|-------|-------------|------|------|
| | | MIN | NOM | MAX |
| Number of Pins | N | 10 | | |
| Pitch | e | 0.50 BSC | | |
| Overall Height | A | 0.80 | 0.90 | 1.00 |
| Standoff | A1 | 0.00 | 0.02 | 0.05 |
| Contact Thickness | A3 | 0.20 REF | | |
| Overall Length | D | 3.00 BSC | | |
| Exposed Pad Length | D2 | 2.20 | 2.35 | 2.48 |
| Overall Width | E | 3.00 BSC | | |
| Exposed Pad Width | E2 | 1.40 | 1.58 | 1.75 |
| Contact Width | b | 0.18 | 0.25 | 0.30 |
| Contact Length | L | 0.30 | 0.40 | 0.50 |
| Contact-to-Exposed Pad | K | 0.20 | - | - |

Notes:

- Pin 1 visual index feature may vary, but must be located within the hatched area.
- Package may have one or more exposed tie bars at ends.
- Package is saw singulated.
- Dimensioning and tolerancing per ASME Y14.5M.

BSC: Basic Dimension. Theoretically exact value shown without tolerances.

REF: Reference Dimension, usually without tolerance, for information purposes only.

Microchip Technology Drawing C04-063B

10-Lead Plastic Dual Flat, No Lead Package (MF) – 3x3x0.9 mm Body [DFN]

Note: For the most current package drawings, please see the Microchip Packaging Specification located at <http://www.microchip.com/packaging>

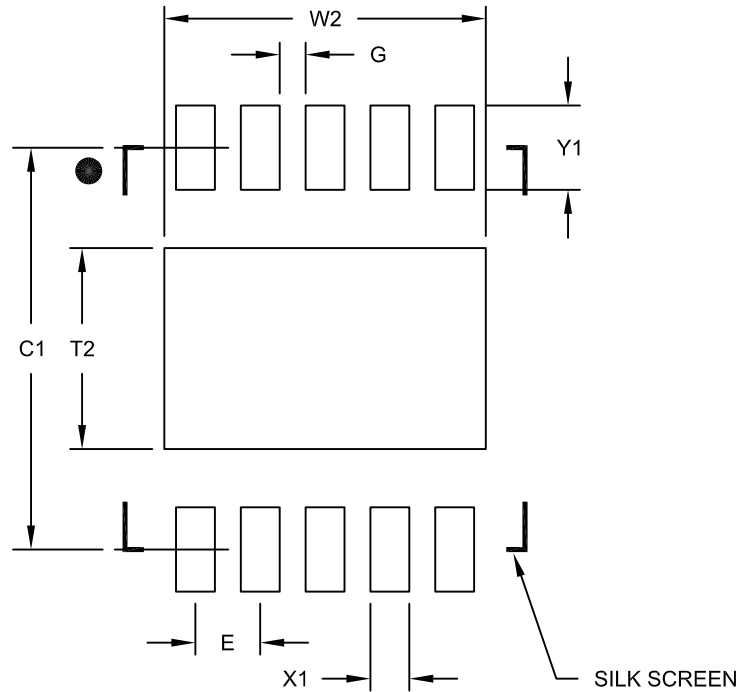

RECOMMENDED LAND PATTERN

| Dimension Limits | Units | MILLIMETERS | | |
|----------------------------|-------|-------------|------|------|
| | | MIN | NOM | MAX |
| Contact Pitch | E | 0.50 BSC | | |
| Optional Center Pad Width | W2 | | | 2.48 |
| Optional Center Pad Length | T2 | | | 1.55 |
| Contact Pad Spacing | C1 | | 3.10 | |
| Contact Pad Width (X8) | X1 | | | 0.30 |
| Contact Pad Length (X8) | Y1 | | | 0.65 |
| Distance Between Pads | G | 0.20 | | |

Notes:

1. Dimensioning and tolerancing per ASME Y14.5M

BSC: Basic Dimension. Theoretically exact value shown without tolerances.

Microchip Technology Drawing No. C04-2063A

MCP631/2/3/5

10-Lead Plastic Micro Small Outline Package (UN) [MSOP]

Note: For the most current package drawings, please see the Microchip Packaging Specification located at <http://www.microchip.com/packaging>

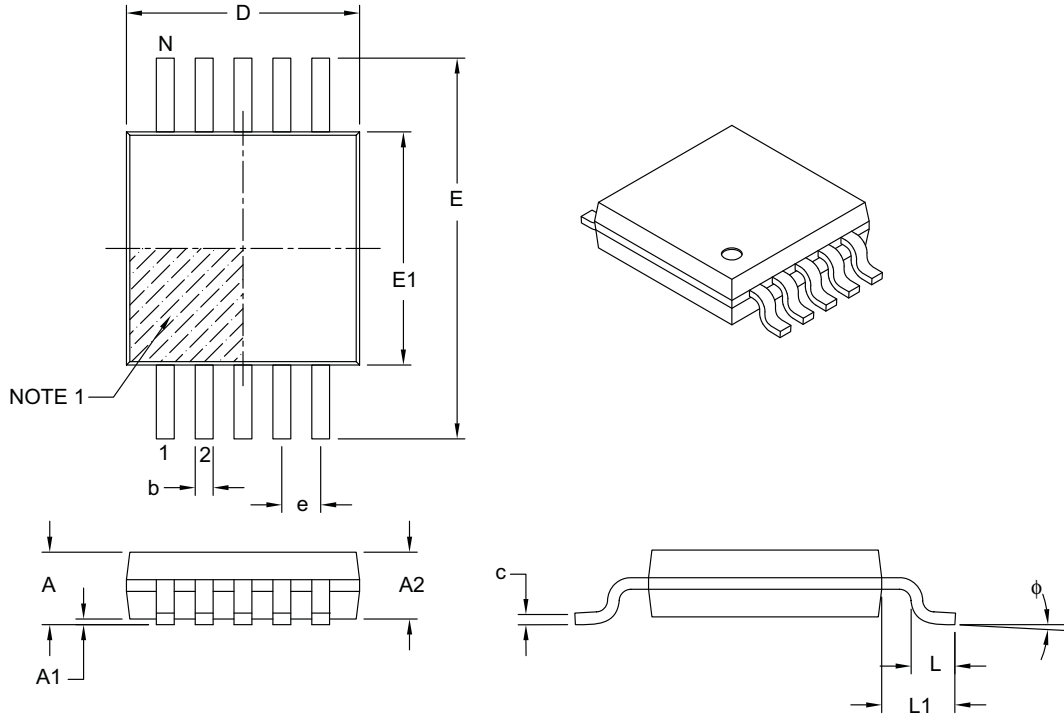

| Dimension Limits | Units | MILLIMETERS | | |
|--------------------------|--------|-------------|------|------|
| | | MIN | NOM | MAX |
| Number of Pins | N | 10 | | |
| Pitch | e | 0.50 BSC | | |
| Overall Height | A | – | – | 1.10 |
| Molded Package Thickness | A2 | 0.75 | 0.85 | 0.95 |
| Standoff | A1 | 0.00 | – | 0.15 |
| Overall Width | E | 4.90 BSC | | |
| Molded Package Width | E1 | 3.00 BSC | | |
| Overall Length | D | 3.00 BSC | | |
| Foot Length | L | 0.40 | 0.60 | 0.80 |
| Footprint | L1 | 0.95 REF | | |
| Foot Angle | ϕ | 0° | – | 8° |
| Lead Thickness | c | 0.08 | – | 0.23 |
| Lead Width | b | 0.15 | – | 0.33 |

Notes:

- Pin 1 visual index feature may vary, but must be located within the hatched area.
- Dimensions D and E1 do not include mold flash or protrusions. Mold flash or protrusions shall not exceed 0.15 mm per side.
- Dimensioning and tolerancing per ASME Y14.5M.

BSC: Basic Dimension. Theoretically exact value shown without tolerances.

REF: Reference Dimension, usually without tolerance, for information purposes only.

Microchip Technology Drawing C04-021B

APPENDIX A: REVISION HISTORY

Revision A (August 2009)

- Original Release of this Document.

MCP631/2/3/5

NOTES:

PRODUCT IDENTIFICATION SYSTEM

To order or obtain information, e.g., on pricing or delivery, refer to the factory or the listed sales office.

| <u>PART NO.</u> | <u>-X</u> | <u>/XX</u> | Examples: |
|--------------------|--------------------------|--|--|
| Device | Temperature Range | Package | |
| Device: | MCP631 | Single Op Amp | a) MCP631T-E/SN: Tape and Reel Extended temperature, 8LD SOIC package |
| | MCP631T | Single Op Amp (Tape and Reel) (SOIC) | a) MCP632T-E/MF: Tape and Reel Extended temperature, 8LD DFN package |
| | MCP632 | Dual Op Amp | b) MCP632T-E/SN: Tape and Reel Extended temperature, 8LD SOIC package |
| | MCP632T | Dual Op Amp (Tape and Reel) (DFN and SOIC) | a) MCP633T-E/SN: Tape and Reel Extended temperature, 8LD SOIC package |
| | MCP633 | Single Op Amp with \overline{CS} | a) MCP635T-E/MF: Tape and Reel Extended temperature, 10LD DFN package |
| | MCP633T | Single Op Amp with \overline{CS} (Tape and Reel) (SOIC) | b) MCP635T-E/UN: Tape and Reel Extended temperature, 10LD MSOP package |
| | MCP635 | Dual Op Amp with \overline{CS} | |
| | MCP635T | Dual Op Amp with \overline{CS} (Tape and Reel) (DFN and MSOP) | |
| Temperature Range: | E | = -40°C to +125°C | |
| Package: | MF | = Plastic Dual Flat, No Lead (3×3 DFN), 8-lead, 10-lead | |
| | SN | = Plastic Small Outline (3.90 mm), 8-lead | |
| | UN | = Plastic Micro Small Outline (MSOP), 10-lead | |

MCP631/2/3/5

NOTES:

Note the following details of the code protection feature on Microchip devices:

- Microchip products meet the specification contained in their particular Microchip Data Sheet.
- Microchip believes that its family of products is one of the most secure families of its kind on the market today, when used in the intended manner and under normal conditions.
- There are dishonest and possibly illegal methods used to breach the code protection feature. All of these methods, to our knowledge, require using the Microchip products in a manner outside the operating specifications contained in Microchip's Data Sheets. Most likely, the person doing so is engaged in theft of intellectual property.
- Microchip is willing to work with the customer who is concerned about the integrity of their code.
- Neither Microchip nor any other semiconductor manufacturer can guarantee the security of their code. Code protection does not mean that we are guaranteeing the product as “unbreakable.”

Code protection is constantly evolving. We at Microchip are committed to continuously improving the code protection features of our products. Attempts to break Microchip's code protection feature may be a violation of the Digital Millennium Copyright Act. If such acts allow unauthorized access to your software or other copyrighted work, you may have a right to sue for relief under that Act.

Information contained in this publication regarding device applications and the like is provided only for your convenience and may be superseded by updates. It is your responsibility to ensure that your application meets with your specifications. MICROCHIP MAKES NO REPRESENTATIONS OR WARRANTIES OF ANY KIND WHETHER EXPRESS OR IMPLIED, WRITTEN OR ORAL, STATUTORY OR OTHERWISE, RELATED TO THE INFORMATION, INCLUDING BUT NOT LIMITED TO ITS CONDITION, QUALITY, PERFORMANCE, MERCHANTABILITY OR FITNESS FOR PURPOSE. Microchip disclaims all liability arising from this information and its use. Use of Microchip devices in life support and/or safety applications is entirely at the buyer's risk, and the buyer agrees to defend, indemnify and hold harmless Microchip from any and all damages, claims, suits, or expenses resulting from such use. No licenses are conveyed, implicitly or otherwise, under any Microchip intellectual property rights.

Trademarks

The Microchip name and logo, the Microchip logo, dsPIC, KEELOQ, KEELOQ logo, MPLAB, PIC, PICmicro, PICSTART, rPIC and UNI/O are registered trademarks of Microchip Technology Incorporated in the U.S.A. and other countries.

FilterLab, Hampshire, HI-TECH C, Linear Active Thermistor, MXDEV, MXLAB, SEEVAL and The Embedded Control Solutions Company are registered trademarks of Microchip Technology Incorporated in the U.S.A.

Analog-for-the-Digital Age, Application Maestro, CodeGuard, dsPICDEM, dsPICDEM.net, dsPICworks, dsSPEAK, ECAN, ECONOMONITOR, FanSense, HI-TIDE, In-Circuit Serial Programming, ICSP, Mindi, MiWi, MPASM, MPLAB Certified logo, MPLIB, MPLINK, mTouch, Octopus, Omniscient Code Generation, PICC, PICC-18, PICDEM, PICDEM.net, PICkit, PICtail, PIC³² logo, REAL ICE, rLAB, Select Mode, Total Endurance, TSHARC, UniWinDriver, WiperLock and ZENA are trademarks of Microchip Technology Incorporated in the U.S.A. and other countries.

SQTP is a service mark of Microchip Technology Incorporated in the U.S.A.

All other trademarks mentioned herein are property of their respective companies.

© 2009, Microchip Technology Incorporated, Printed in the U.S.A., All Rights Reserved.

 Printed on recycled paper.

QUALITY MANAGEMENT SYSTEM
CERTIFIED BY DNV
== ISO/TS 16949:2002 ==

Microchip received ISO/TS-16949:2002 certification for its worldwide headquarters, design and wafer fabrication facilities in Chandler and Tempe, Arizona; Gresham, Oregon and design centers in California and India. The Company's quality system processes and procedures are for its PIC® MCUs and dsPIC® DSCs, KEELOQ® code hopping devices, Serial EEPROMs, microperipherals, nonvolatile memory and analog products. In addition, Microchip's quality system for the design and manufacture of development systems is ISO 9001:2000 certified.



WORLDWIDE SALES AND SERVICE

AMERICAS

Corporate Office
2355 West Chandler Blvd.
Chandler, AZ 85224-6199
Tel: 480-792-7200
Fax: 480-792-7277
Technical Support:
<http://support.microchip.com>
Web Address:
www.microchip.com

Atlanta
Duluth, GA
Tel: 678-957-9614
Fax: 678-957-1455

Boston
Westborough, MA
Tel: 774-760-0087
Fax: 774-760-0088

Chicago
Itasca, IL
Tel: 630-285-0071
Fax: 630-285-0075

Cleveland
Independence, OH
Tel: 216-447-0464
Fax: 216-447-0643

Dallas
Addison, TX
Tel: 972-818-7423
Fax: 972-818-2924

Detroit
Farmington Hills, MI
Tel: 248-538-2250
Fax: 248-538-2260

Kokomo
Kokomo, IN
Tel: 765-864-8360
Fax: 765-864-8387

Los Angeles
Mission Viejo, CA
Tel: 949-462-9523
Fax: 949-462-9608

Santa Clara
Santa Clara, CA
Tel: 408-961-6444
Fax: 408-961-6445

Toronto
Mississauga, Ontario,
Canada
Tel: 905-673-0699
Fax: 905-673-6509

ASIA/PACIFIC

Asia Pacific Office
Suites 3707-14, 37th Floor
Tower 6, The Gateway
Harbour City, Kowloon
Hong Kong
Tel: 852-2401-1200
Fax: 852-2401-3431

Australia - Sydney
Tel: 61-2-9868-6733
Fax: 61-2-9868-6755

China - Beijing
Tel: 86-10-8528-2100
Fax: 86-10-8528-2104

China - Chengdu
Tel: 86-28-8665-5511
Fax: 86-28-8665-7889

China - Hong Kong SAR
Tel: 852-2401-1200
Fax: 852-2401-3431

China - Nanjing
Tel: 86-25-8473-2460
Fax: 86-25-8473-2470

China - Qingdao
Tel: 86-532-8502-7355
Fax: 86-532-8502-7205

China - Shanghai
Tel: 86-21-5407-5533
Fax: 86-21-5407-5066

China - Shenyang
Tel: 86-24-2334-2829
Fax: 86-24-2334-2393

China - Shenzhen
Tel: 86-755-8203-2660
Fax: 86-755-8203-1760

China - Wuhan
Tel: 86-27-5980-5300
Fax: 86-27-5980-5118

China - Xiamen
Tel: 86-592-2388138
Fax: 86-592-2388130

China - Xian
Tel: 86-29-8833-7252
Fax: 86-29-8833-7256

China - Zhuhai
Tel: 86-756-3210040
Fax: 86-756-3210049

ASIA/PACIFIC

India - Bangalore
Tel: 91-80-3090-4444
Fax: 91-80-3090-4080

India - New Delhi
Tel: 91-11-4160-8631
Fax: 91-11-4160-8632

India - Pune
Tel: 91-20-2566-1512
Fax: 91-20-2566-1513

Japan - Yokohama
Tel: 81-45-471- 6166
Fax: 81-45-471-6122

Korea - Daegu
Tel: 82-53-744-4301
Fax: 82-53-744-4302

Korea - Seoul
Tel: 82-2-554-7200
Fax: 82-2-558-5932 or
82-2-558-5934

Malaysia - Kuala Lumpur
Tel: 60-3-6201-9857
Fax: 60-3-6201-9859

Malaysia - Penang
Tel: 60-4-227-8870
Fax: 60-4-227-4068

Philippines - Manila
Tel: 63-2-634-9065
Fax: 63-2-634-9069

Singapore
Tel: 65-6334-8870
Fax: 65-6334-8850

Taiwan - Hsin Chu
Tel: 886-3-6578-300
Fax: 886-3-6578-370

Taiwan - Kaohsiung
Tel: 886-7-536-4818
Fax: 886-7-536-4803

Taiwan - Taipei
Tel: 886-2-2500-6610
Fax: 886-2-2508-0102

Thailand - Bangkok
Tel: 66-2-694-1351
Fax: 66-2-694-1350

EUROPE

Austria - Wels
Tel: 43-7242-2244-39
Fax: 43-7242-2244-393

Denmark - Copenhagen
Tel: 45-4450-2828
Fax: 45-4485-2829

France - Paris
Tel: 33-1-69-53-63-20
Fax: 33-1-69-30-90-79

Germany - Munich
Tel: 49-89-627-144-0
Fax: 49-89-627-144-44

Italy - Milan
Tel: 39-0331-742611
Fax: 39-0331-466781

Netherlands - Drunen
Tel: 31-416-690399
Fax: 31-416-690340

Spain - Madrid
Tel: 34-91-708-08-90
Fax: 34-91-708-08-91

UK - Wokingham
Tel: 44-118-921-5869
Fax: 44-118-921-5820

03/26/09