

SMD Zener Diode



SMD Diodes Specialist

CZRH5221B-G Thru CZRH5267B-G

Voltage: 2.4 to 75 Volts

Power: 150 mWatts

RoHS Device

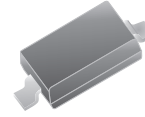

Features

For surface mounted applications.

150mW Power Dissipation.

Ideally suited for automated assembly processes.

Pb free product.

Mechanical data

Case: SOD-523, Molded plastic.

Terminals: Solder Plated, solderable per MIL-STD-750, method 2026.

Polarity: Cathode band.

Weight: 0.0012 gram (approx.).

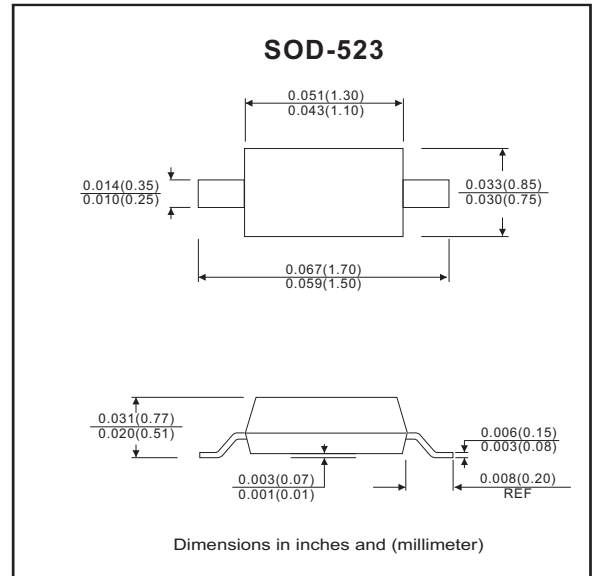

Maximum Rating AND Electrical Characteristics

Parameter	Symbol	Value	Unit
Maximum Power Dissipation, $T_A = 25^\circ\text{C}$	P_D	150	mW
Operating Junction and Storage Temperature Range	T_J	-55 to +150	$^\circ\text{C}$

Electrical Characteristics(Ta = 25°C)

Part Number	Zener Voltage			Operating resistance		Rising operating resistance		Reverse current		Marking Code
	Vz(V)@IzT			ZzT(Ohm)		Zzk(Ohm)		IR(uA)		
	Min	Nom	Max	Max	IzT(mA)	Max	Izk(mA)	Max	VR(V)	
CZRH5221B-G	2.28	2.4	2.52	30	20	1200	0.25	100	1	C1
CZRH5222B-G	2.38	2.5	2.63	30	20	1250	0.25	100	1	C2
CZRH5223B-G	2.57	2.7	2.84	30	20	1300	0.25	75	1	C3
CZRH5225B-G	2.85	3	3.15	30	20	1600	0.25	50	1	C5
CZRH5226B-G	3.14	3.3	3.47	28	20	1600	0.25	25	1	D1
CZRH5227B-G	3.42	3.6	3.78	24	20	1700	0.25	15	1	D2
CZRH5228B-G	3.71	3.9	4.1	23	20	1900	0.25	10	1	D3
CZRH5229B-G	4.09	4.3	4.52	22	20	2000	0.25	5	1	D4
CZRH5230B-G	4.47	4.7	4.94	19	20	1900	0.25	5	2	D5
CZRH5231B-G	4.85	5.1	5.36	17	20	1600	0.25	5	2	E1
CZRH5232B-G	5.32	5.6	5.88	11	20	1600	0.25	5	3	E2
CZRH5234B-G	5.89	6.2	6.51	7	20	1000	0.25	5	4	E4
CZRH5235B-G	6.46	6.8	7.14	5	20	750	0.25	3	5	E5
CZRH5236B-G	7.13	7.5	7.88	6	20	500	0.25	3	6	F1
CZRH5237B-G	7.79	8.2	8.61	8	20	500	0.25	3	6	F2
CZRH5239B-G	8.65	9.1	9.56	10	20	600	0.25	3	6.5	F4
CZRH5240B-G	9.5	10	10.5	17	20	600	0.25	3	8	F5
CZRH5241B-G	10.45	11	11.55	22	20	600	0.25	3	8.4	H1
CZRH5242B-G	11.4	12	12.6	30	20	600	0.25	2	9.1	H2
CZRH5243B-G	12.35	13	13.65	13	9.5	600	0.25	1	9.9	H3
CZRH5244B-G	13.3	14	14.7	15	9.0	600	0.25	0.5	10.5	H4
CZRH5245B-G	14.25	15	15.75	16	8.5	600	0.25	0.5	11	H5
CZRH5246B-G	15.2	16	16.8	17	7.8	600	0.25	0.1	12	J1
CZRH5247B-G	16.15	17	17.85	19	7.5	600	0.25	0.1	13	J2
CZRH5248B-G	17.1	18	18.9	21	7	600	0.25	0.1	14	J3
CZRH5250B-G	19	20	21	25	6.2	600	0.25	0.1	15	J5
CZRH5251B-G	20.9	22	23.1	29	5.6	600	0.25	0.1	17	K1
CZRH5252B-G	22.8	24	25.2	33	5.2	600	0.25	0.1	18	K2
CZRH5254B-G	25.65	27	28.35	41	5	600	0.25	0.1	21	K4
CZRH5255B-G	26.6	28	29.4	44	4.5	600	0.25	0.1	21	K5
CZRH5256B-G	28.5	30	31.5	49	4.2	600	0.25	0.1	23	M1
CZRH5257B-G	31.35	33	34.65	58	3.8	700	0.25	0.1	25	M2
CZRH5258B-G	34.2	36	37.8	70	3.4	700	0.25	0.1	27	M3
CZRH5259B-G	37.05	39	40.95	80	3.2	800	0.25	0.1	30	M4
CZRH5260B-G	40.85	43	45.15	93	3	900	0.25	0.1	33	M5
CZRH5261B-G	44.65	47	49.35	105	2.7	1000	0.25	0.1	36	N1
CZRH5262B-G	48.45	51	53.55	125	2.5	1100	0.25	0.1	39	N2
CZRH5263B-G	53.2	56	58.8	150	2.2	1300	0.25	0.1	43	N3
CZRH5264B-G	57	60	63	170	2.1	1400	0.25	0.1	46	N4
CZRH5265B-G	58.9	62	65.1	185	2	1500	0.25	0.1	47	N5
CZRH5266B-G	64.6	68	71.4	230	1.8	1600	0.25	0.1	52	P1
CZRH5267B-G	71.25	75	78.75	270	1.7	1400	0.25	0.1	56	P2

RATING AND CHARACTERISTIC CURVES (CZRH5221B-G Thru CZRH5267B-G)

Fig.1 Typical forward voltage

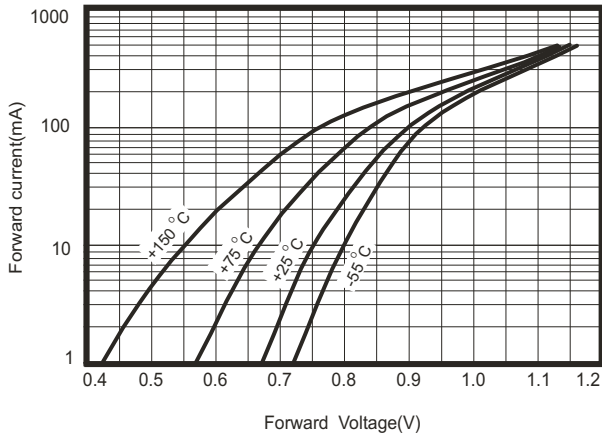

Fig.2 Typical leakage current

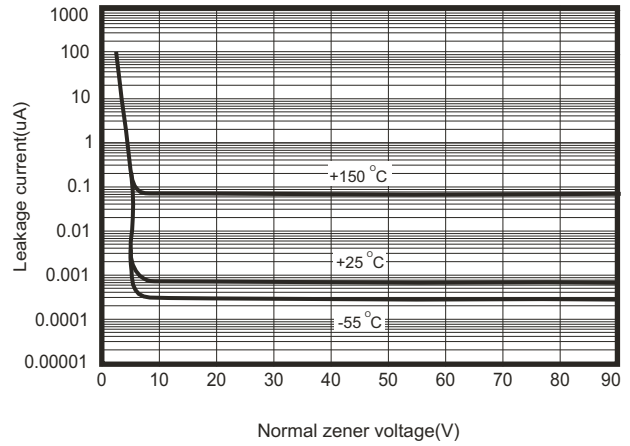

Fig.3 Temperature coefficients

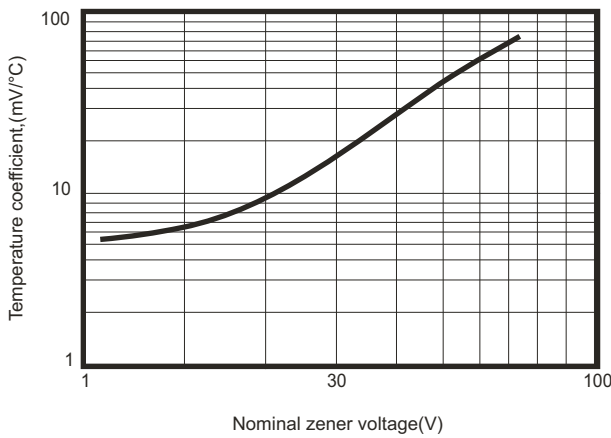
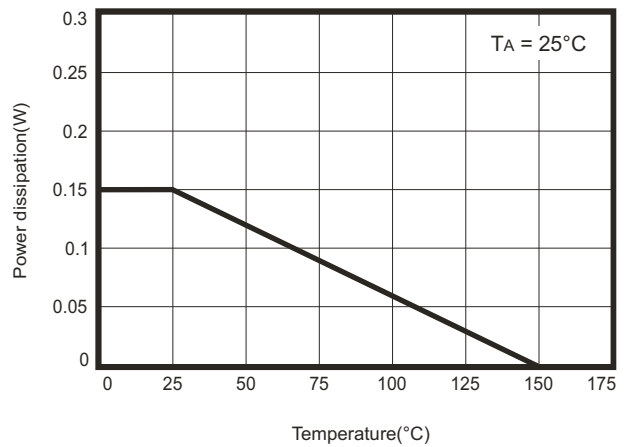
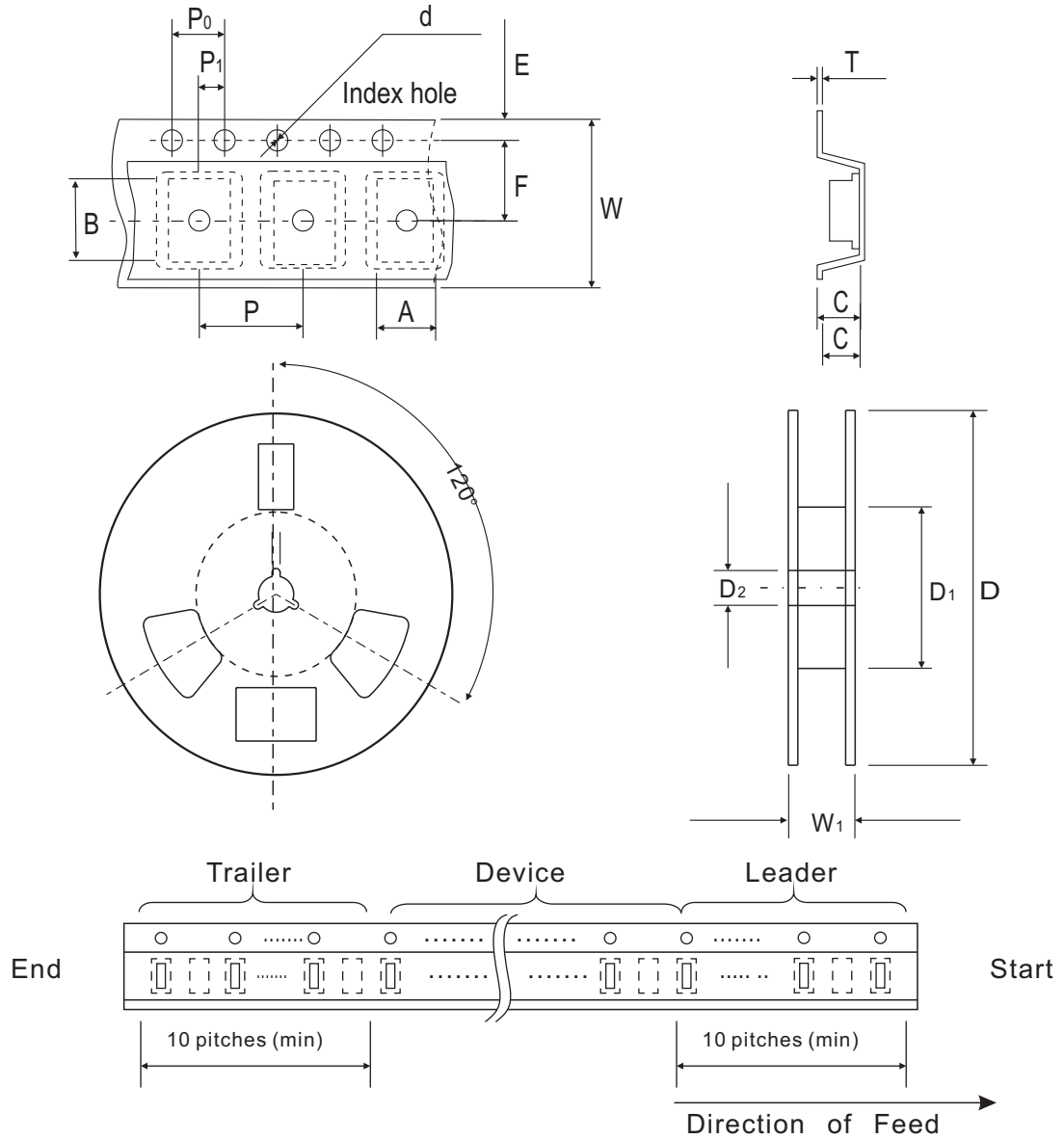

Fig.4 Steady state power derating



Reel Taping Specification



SOD-523	SYMBOL	A	B	C	d	D	D ₁	D ₂
	(mm)	0.96 ± 0.05	1.94 ± 0.05	0.73 ± 0.05	1.50 ± 0.10	178 ± 1	54.4 ± 0.4	1.30 ± 0.05
	(inch)	0.038 ± 0.002	0.076 ± 0.002	0.029 ± 0.002	0.059 ± 0.004	7.008 ± 0.04	2.142 ± 0.016	0.512 ± 0.002

SOD-523	SYMBOL	E	F	P	P ₀	P ₁	T	W	W ₁
	(mm)	1.75 ± 0.10	3.50 ± 0.05	2.00 ± 0.05	4.00 ± 0.10	2.00 ± 0.05	0.18 ± 0.02	8.00 ± 0.40	12.3 ± 0.20
	(inch)	0.069 ± 0.004	0.138 ± 0.002	0.079 ± 0.002	0.157 ± 0.004	0.079 ± 0.002	0.007 ± 0.001	0.315 ± 0.016	0.484 ± 0.008

Suggested PAD Layout

SIZE	SOD-523	
	(mm)	(inch)
A	1.40	0.055
B	0.60	0.024
C	0.70	0.028
D	2.00	0.079
E	0.80	0.031

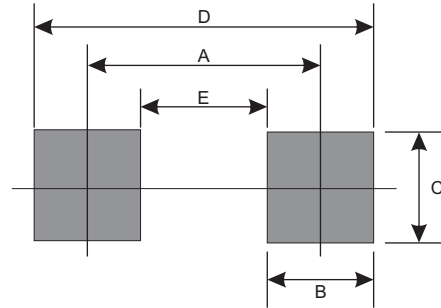

Standard Package

Case Type	Qty per Reel	Reel Size
	(Pcs)	(inch)
SOD-523	3000	7