

RoHS Compliant Product

A suffix of "-C" specifies halogen & lead-free

FEATURES

- Low Turn-on Voltage
- Fast Switching
- PN Junction Guard Ring for Transient and ESD Protection

MECHANICAL DATA

- Case: SOT-23, Molded Plastic
- Terminals: Solderable per MIL-STD-202, Method 208
- Polarity: See Diagrams Below
- Weight: 0.008 grams (approx.)
- Mounting Position: Any

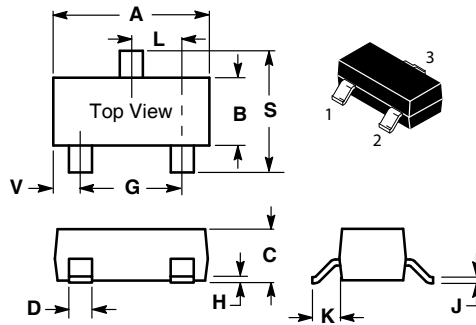

SOT-23		
Dim	Min	Max
A	2.800	3.040
B	1.200	1.400
C	0.890	1.110
D	0.370	0.500
G	1.780	2.040
H	0.013	0.100
J	0.085	0.177
K	0.450	0.600
L	0.890	1.020
S	2.100	2.500
V	0.450	0.600
All Dimension in mm		

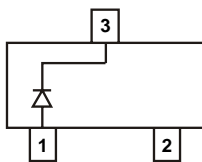

BAT54 Marking: LV3,KL1

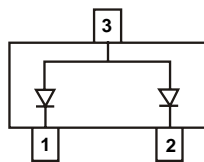

BAT54A Marking: B6,KL2

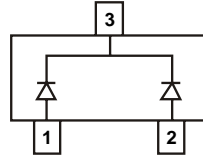

BAT54C Marking: B5,KL3

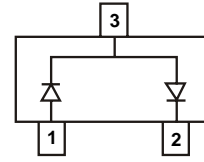

BAT54S Marking: LD3,KL4

MAXIMUM RATINGS ($T_J = 125^\circ\text{C}$ unless otherwise noted)

Rating	Symbol	Value	Unit
Reverse Voltage	V_R	30	Volts
Forward Power Dissipation @ $T_A = 25^\circ\text{C}$ Derate above 25°C	P_F	225 1.8	mW mW/°C
Forward Current (DC)	I_F	200 Max	mA
Junction Temperature	T_J	125 Max	°C
Storage Temperature Range	T_{stg}	-55 to +150	°C

ELECTRICAL CHARACTERISTICS ($T_A = 25^\circ\text{C}$ unless otherwise noted) (EACH DIODE)

Characteristic	Symbol	Min	Typ	Max	Unit
Reverse Breakdown Voltage ($I_R = 10 \mu\text{A}$)	$V_{(BR)R}$	30	—	—	Volts
Total Capacitance ($V_R = 1.0 \text{ V}$, $f = 1.0 \text{ MHz}$)	C_T	—	7.6	10	pF
Reverse Leakage ($V_R = 25 \text{ V}$)	I_R	—	0.5	2.0	μA_{dc}
Forward Voltage ($I_F = 0.1 \text{ mA}_{dc}$)	V_F	—	0.22	0.24	V _{dc}
Forward Voltage ($I_F = 30 \text{ mA}_{dc}$)	V_F	—	0.41	0.5	V _{dc}
Forward Voltage ($I_F = 100 \text{ mA}_{dc}$)	V_F	—	0.52	1.0	V _{dc}
Reverse Recovery Time ($I_F = I_R = 10 \text{ mA}_{dc}$, $I_{R(REC)} = 1.0 \text{ mA}_{dc}$) Figure 1	t_{rr}	—	—	5.0	ns
Forward Voltage ($I_F = 1.0 \text{ mA}_{dc}$)	V_F	—	0.29	0.32	V _{dc}
Forward Voltage ($I_F = 10 \text{ mA}_{dc}$)	V_F	—	0.35	0.40	V _{dc}
Forward Current (DC)	I_F	—	—	200	mA _{dc}
Repetitive Peak Forward Current	I_{FRM}	—	—	300	mA _{dc}
Non-Repetitive Peak Forward Current ($t < 1.0 \text{ s}$)	I_{FSM}	—	—	600	mA _{dc}

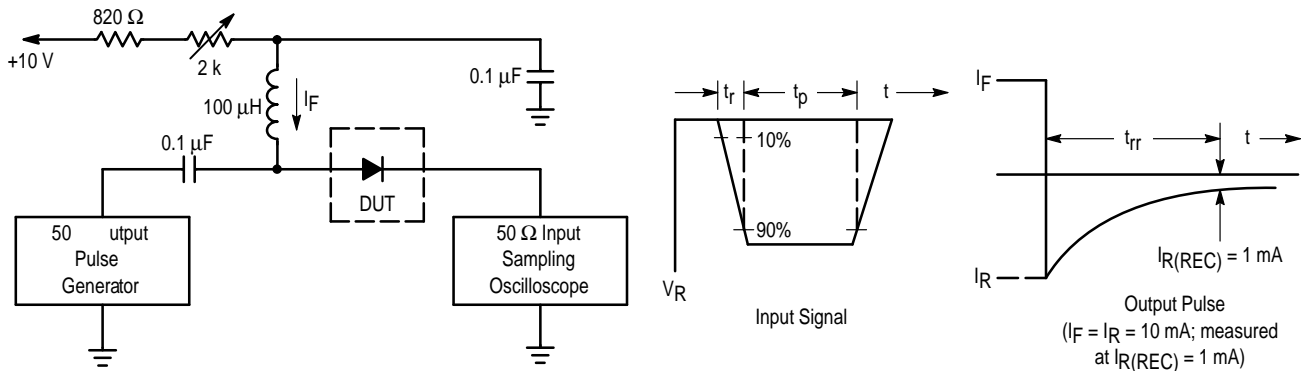

- Notes: 1. A 2.0 kΩ variable resistor adjusted for a Forward Current (I_F) of 10 mA.
2. Input pulse is adjusted so $I_{R(peak)}$ is equal to 10 mA.
3. $t_p \gg t_{rr}$

Figure 1. Recovery Time Equivalent Test Circuit

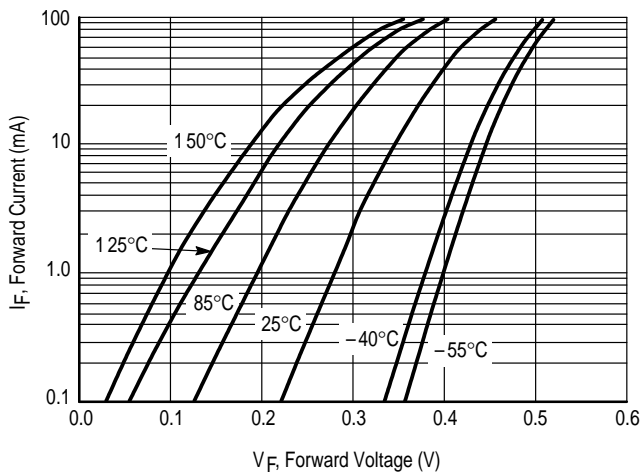

Figure 2. Forward Voltage

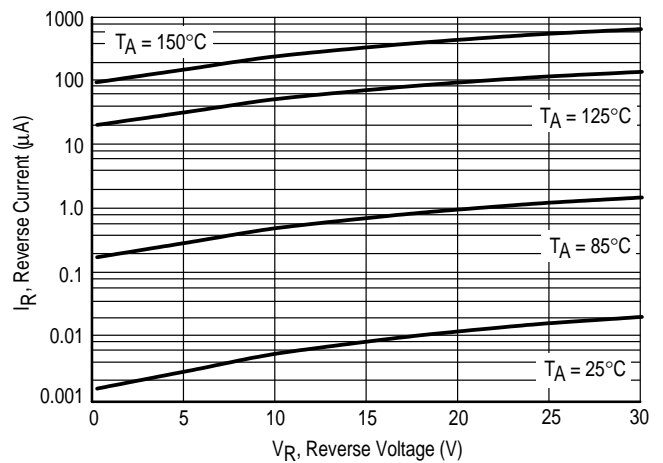

Figure 3. Leakage Current

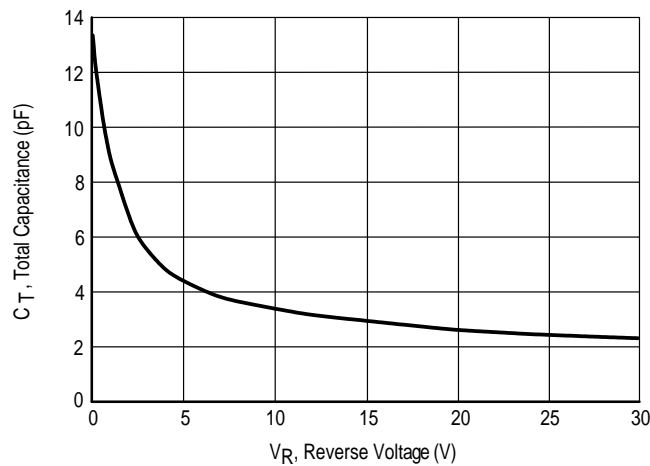

Figure 4. Total Capacitance